

iFit series



Helical Inline and Bevel Helical gearmotors



Contents

1	Rossi for You	6
	1.1 Global presence, local service	8
2	Product Overview	10
	2.1 Features & Benefits	12
	2.2 Electric motors	14
	2.3 Inverter	15
	2.4 Product Range	16
3	Symbols and units of measure	18
	3.1 Symbols and units of measure	20
	3.2 Icons	22
4	Product specifications	24
	4.1 General specifications	26
	4.2 Operational conditions	29
	4.3 Surface protection	32
	4.4 Storage and warehousing	33
5	Designation	34
	5.1 Coding	36
	5.2 Nameplate data	44
6	Project Planning	46
	6.1 Selection	48
	6.2 Service factor f_s	51
	6.3 Efficiency	52
	6.4 Thermal power P_t	53
	6.5 Radial loads on low speed shaft end	55
7	Mounting positions	58
	7.1 Mounting positions	60
	7.2 Plug position	62

8	Structural and operational details	70
	8.1 Lubrication	72
	8.2 Adapters for motors	74
	8.3 Assembling the motor (IEC or NEMA) on adapter	76
	8.4 Details of gearmotor fastening flanges	76
	8.5 Fastening bolts	77
	8.6 Dimensional tolerances	79
	8.7 Overall dimensional remarks	80
9	Helical inline selection tables - iC	82
	9.1 Possible geometrical combinations	84
	9.2 Geometrical coupling tables	85
	9.3 Selection tables [kW]	94
10	Helical inline dimensional drawings - iC	132
	10.1 iC 272/iC 273	134
	10.2 iC 372/iC 373	136
	10.3 iC 472/iC 473	138
	10.4 iC 572/iC 573	140
	10.5 iC 672/iC 673	142
	10.6 iC 772/iC 773	144
	10.7 iC 872/iC 873	146
	10.8 iC 972/iC 973	148
11	Bevel helical selection tables - iO	150
	11.1 Possible geometrical combinations	152
	11.2 Geometrical coupling tables	153
	11.3 Selection tables [kW]	160
12	Bevel helical dimensional drawings - iO	184
	12.1 iO 373	186
	12.2 iO 473	189
	12.3 iO 573	192
	12.4 iO 673	195
	12.5 iO 773	198
	12.6 iO 873	201
	12.7 iO 973	204

13	Compact three-phase motor HB and brake motor HBZ	208
	13.1 Compact asynchronous three-phase motor HB	210
	13.2 Technical data of compact asynchronous three-phase motor HB	212
	13.3 Compact asynchronous three-phase brake motor HBZ	215
	13.4 Technical data of compact asynchronous three-phase brake motor HBZ	219
14	Installation and maintenance	222
	14.1 Safety	224
	14.2 Installation and maintenance	225
15	Gear selection data sheet	226
16	Technical formulae	227

Rossi for You



Innovation

Rossi S.p.A. offers a wide range of solutions for an evolving industry, flexible and innovative gear reducers and gearmotors for customer tailored solutions to maximize performances and minimize the Total Cost of Ownership (TCO).



High quality, 3 years warranty

Our drive is to innovate and boost operations by manufacturing performing, precise, reliable and high-quality products all over the world. We are always one step forward in offering and developing solutions that can satisfy an unlimited number of application needs, even in the most demanding conditions.



Reliability

We are a reliable company with the right flexibility and know-how to respond to worldwide market requests, in all application fields, without leaving aside our commitment for the environment and value on human safety, to protect everyone's future.



Tools and processes

We continue to invest in new tools and processes, so our highly skilled specialist team in different fields are supporting you to find the best solution suitable for your demands, always by your side on every step of the project.



After-sale service

Highly trained mechanics and support teams can ensure a fast and efficient after-sale service providing support worldwide.



Digital support

Alongside our 24/7 Rossi for You portal you have a suite of digital support tools enabling real time access to your order tracking, invoices, spare part tables download and contact to our service.

70

YEARS

Experience

Shaped by 70 years of history Rossi meets your unique needs whether you need a standard design or a customized solution.



Global presence local service



Local support

Sales, customer service,
technical support, spare parts



15 branches*



Worldwide distribution network*

A global network of subsidiaries and dealers.
From design and execution to after sales service.
Rossi S.p.A. is always close to you, a local reliable and
flexible partner.

Alongside our 24/7 **Rossi for You** portal you have a suite
of digital support tools enabling real time access to your
order tracking, invoices, spare part tables download and
contact to our service.

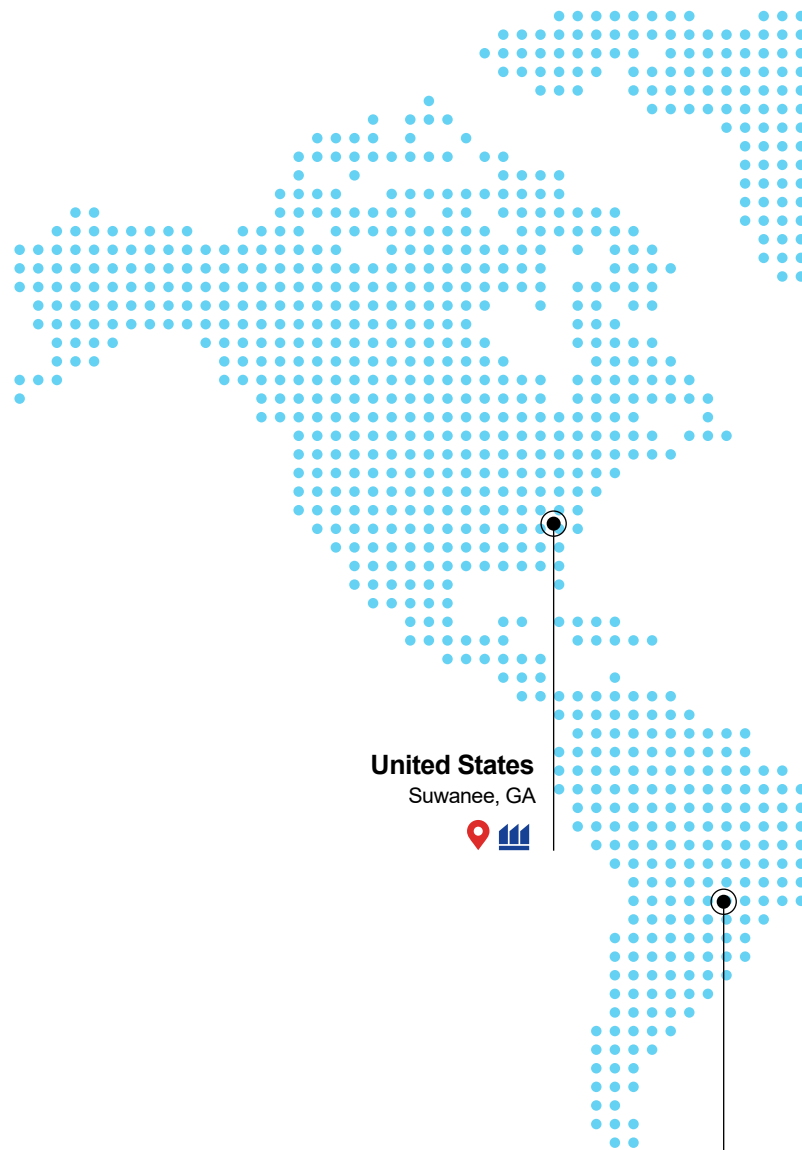

United States
Suwanee, GA



Brazil
Cordeiropolis, SP



*All contacts available on www.rossi.com



Headquarters



Branches



Production facilities/Assembly plants

United Kingdom

Coventry



Netherlands

Panningen



Germany

Dreieich



Poland

Wroclaw



Turkey

Izmir



China

Shanghai



Souzhou



Taiwan

Kaohsiung City



Spain

Barcelona



France

Saint Priest



Italy

Modena



Ganaceto



Lecce



Sud Africa

La Mercy



India

Coimbatore



Australia

Perth



Malesia

Kuala Lumpur



Product Overview

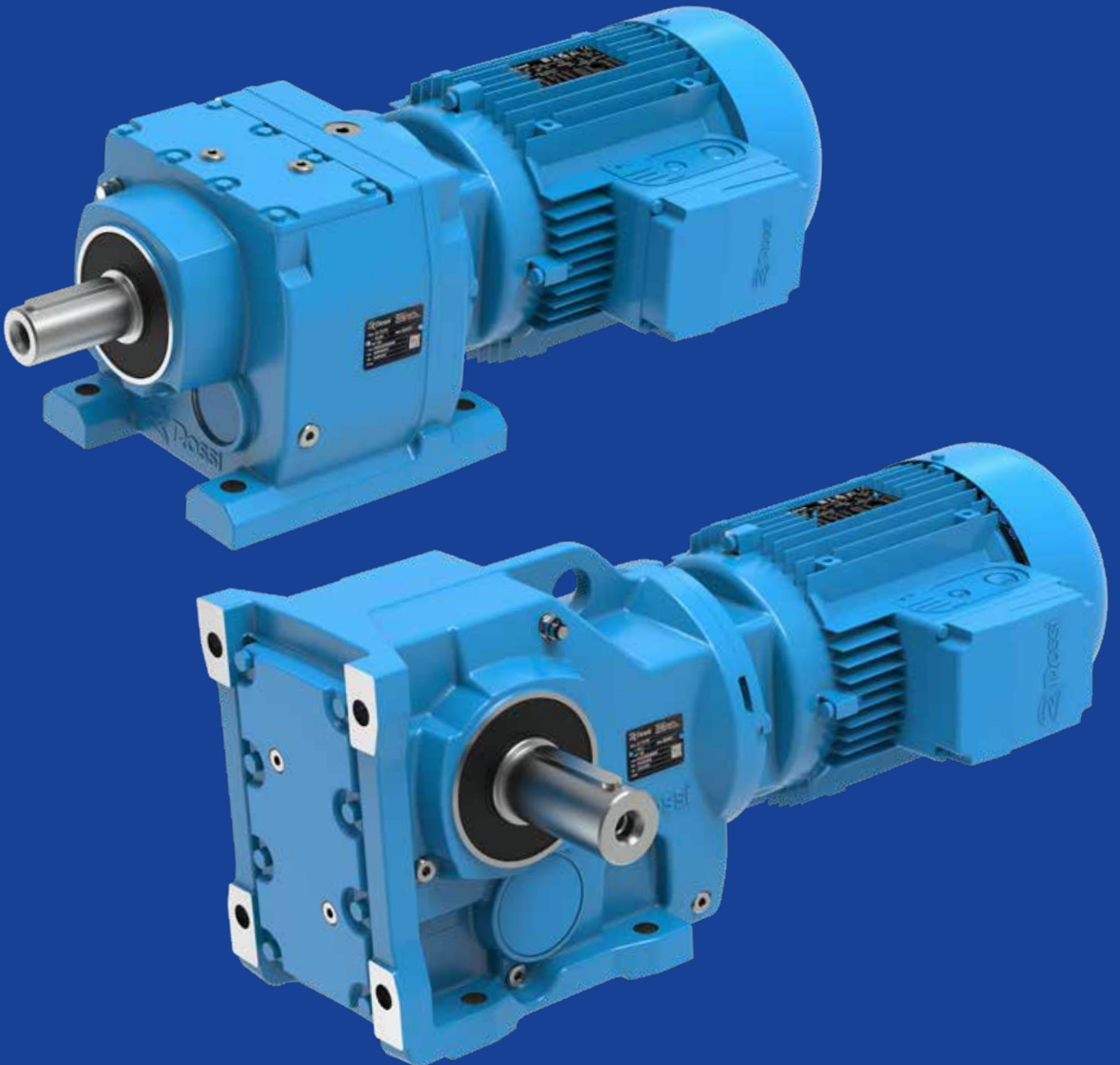

Section contents

2.1	Features & Benefits	12
2.2	Electric motors	14
2.3	Inverter	15
2.4	Product Range	16

2.1

Features & Benefits

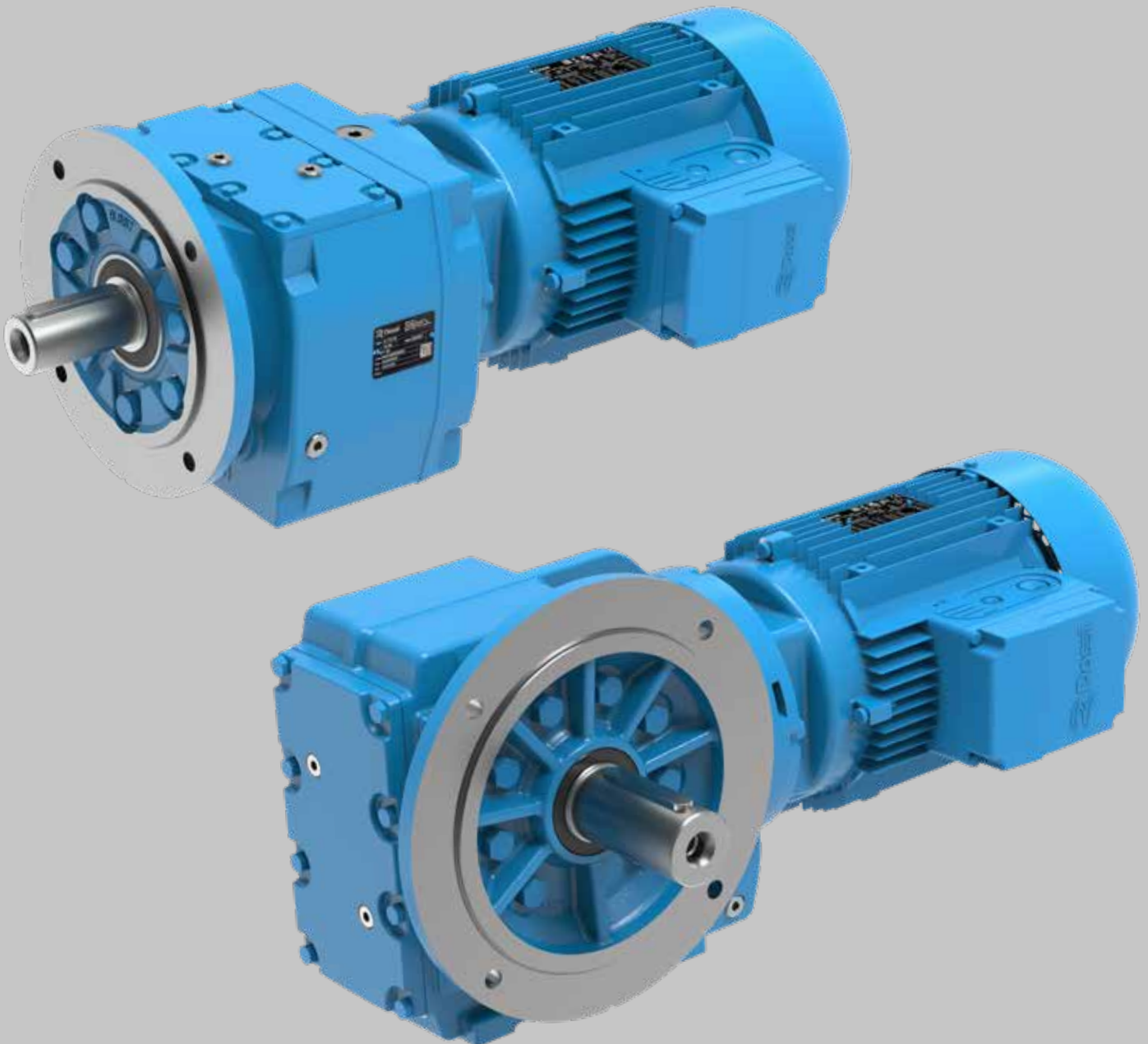



Fully interchangeable

Plug&Play.
No re-engineering costs.



100% made in EU

Superior quality,
minimum maintenance



Cast iron housing

Maximum performance and
reliability



Gear precision DIN/ISO 6

Energy saving, low noise level,
reduced backlash

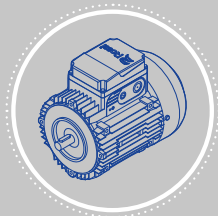

IE3 electric motors

Premium efficiency



High quality

Long life lubrication. Dedicated
motor side sealing system



Compact design

Wash down capability thanks to round
shaped, smooth housing surface



High performance

Up to 12% higher
than market standard

Additional benefits



- High Customer Value
- Short Lead Times for standard products
- 3 Years Guarantee

2.2

Electric motors

- Standard and brake motors
- IE3 class of the international efficiency standard (IEC 60034-30) $\geq 0,75$ kW
- IE2 class of the international efficiency standard (IEC 60034-30) $\leq 0,55$ kW
- Multivoltage, 2, 4 and 6 poles
- Aluminium frame
- Cable entry possible from two sides
- Motor insulation class F, rise temperature B



COMPLIANCE

- Test documents
-  US motors certified to UL
- Machinery Directive 2006/42/EC
- Directive 2011/65/EC RoHS
- Directive «ErP» 2009/125/EC



PROTECTION/PAINTING

- Blue RAL 5010 paint with corrosivity class C3 as standard
(hard and smooth clinging painting)
- IP 55

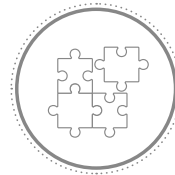

OPTIONS

- Motor insulation class H
- Bi-metal type thermal probes
- Thermistor type (PTC) thermal probes
- Motor with connectors
- Anti-condensation heater
- Forced fan cooling (IC 416)
- Drip-proof cover
- Double shaft extension
- Incremental encoder sin/cos
- Optional painting
- Optional protection grades IP 56 ... IP 66

Inverter

- Max overloads: up to 200%
- Best sensor-less ability to handle overloads
- Flexibility in motor-mounted or wall-mounted installation
- Full "Plug & Play"
- Autotuning, software programming and updating included
- In compliance with IE2 class ECODSIGN EN 50598 IEC/EN 60034-30-1 and Ecodesign Directive in accordance with IEC 61800-9-2
- Remote commissioning, monitoring and diagnostics, Bluetooth, App and Safety (STO)
- Communication and connection among several inverters
- A wide range of Field buses
- Comprehensive options range, components and design concept guarantee the best reliability and vibration resistance. Dust-tight and protected against water jets (IP 65).



Product Range

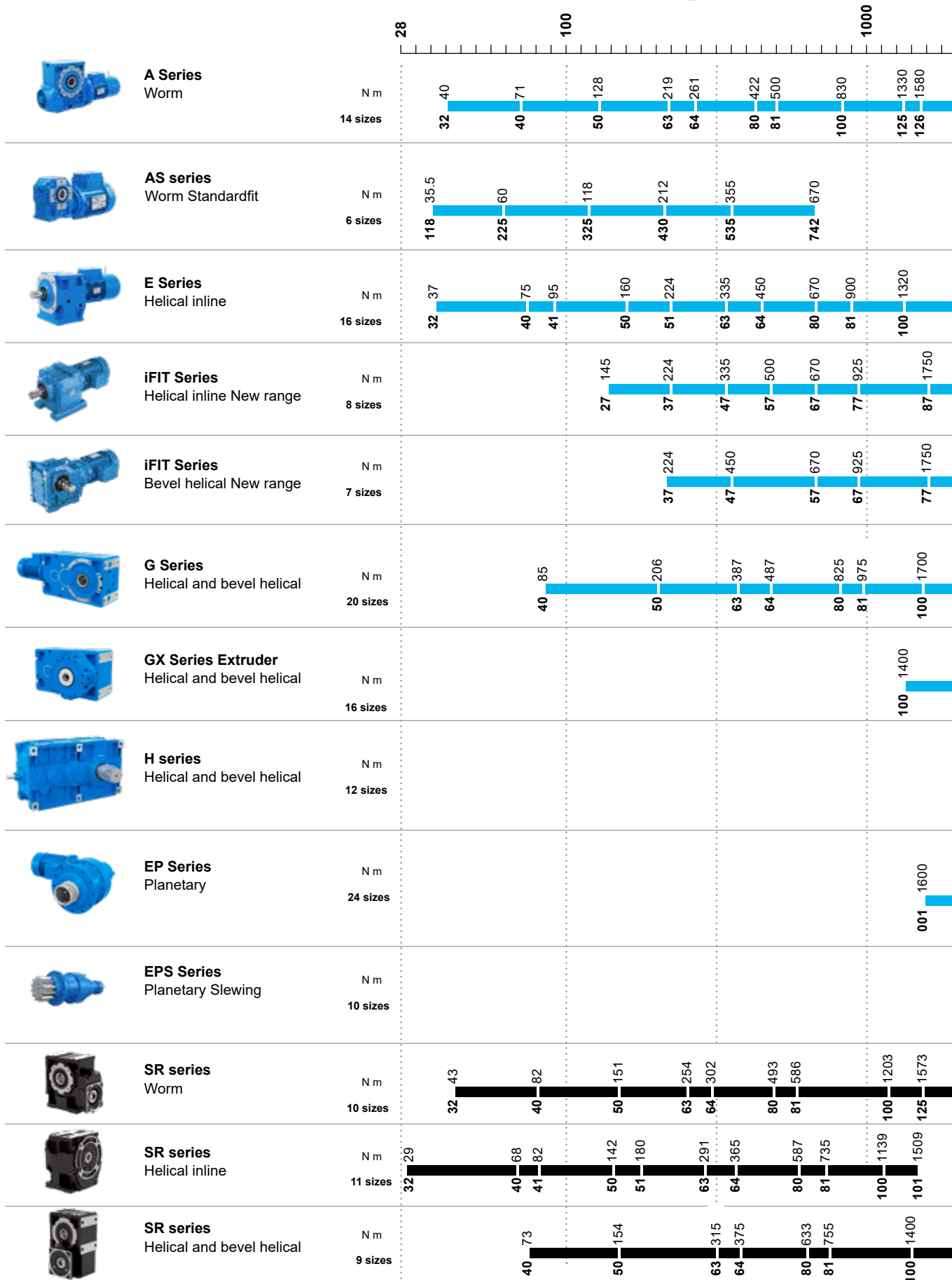

Symbols and units of measure

Section contents

3.1	Symbols and units of measure	20
3.2	Icons	22

3.1













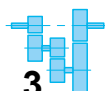

Symbols and units of measure

Symbols	Description	Unit of Measure SI
f_s	service factor	
f_T	thermal factor	
H	altitude	[m]
$IP..$	protection degree	
J	moment of inertia of mass	[kg m ²]
M	torque	[N m]
n	rotational speed	[min ⁻¹]
p	weight	[kg]
P	power	[kW]
$S1...S10$	duty cycle	
T	temperature	[°C]
t	time	[s]
v	linear speed	[m/s]
z	number of starts per hour	[start/h]
Gear reducer		
η	efficiency	
η_s	static efficiency	
F_{r1}	radial loads on high speed shaft	[N]
F_{r2}	radial loads on low speed shaft	[N]
F_{a1}	axial loads on high speed shaft	[N]
F_{a2}	axial loads on low speed shaft	[N]
i	transmission ratio	
L_h	bearing life	[h]
M_{N1}	nominal torque on high speed shaft	[N m]
M_{N2}	nominal torque on low speed shaft	[N m]
M_1	nominal torque on high speed shaft	[N m]
M_2	nominal torque on low speed shaft	[N m]
M_{2max}	maximum torque on low speed shaft	[N m]
M_s	tightening torque for fastening bolts	[N m]
n_1	rotation speed of high speed shaft	[min ⁻¹]
n_2	rotation speed of low speed shaft	[min ⁻¹]
P_{N1}	nominal power on high speed shaft	[kW]
P_{N2}	nominal power on low speed shaft	[kW]
P_T	thermal power	[kW]
P_{TN}	nominal thermal power	[kW]
P_1	power on high speed shaft	[kW]
P_2	power on low speed shaft	[kW]

Symbols	Description	Unit of Measure SI
Motor		
$\cos\varphi$	power factor	
C_{max}	maximum brake disk wear	[mm]
η	motor efficiency	
f	supply frequency	[Hz]
I_N	motor nominal current	[A]
I_S	starting current of the motor	[A]
J_0	moment of inertia (of mass) of the motor	[kg m ²]
M_S	starting torque, with direct on-line start	[N m]
M_{max}	maximum torque, with direct on-line start	[N m]
M_N	nominal torque of the motor	[N m]
M_{fmax}	maximum braking torque	[N m]
M_f	calibration braking torque	[N m]
n_N	number of motor nominal rotations	[min ⁻¹]
P_N	motor nominal power	[kW]
t_a	starting time	[s]
t_f	braking time	[s]
t_1	delay of brake anchor release	[ms]
t_2	delay of braking	[ms]
t_{2cc}	braking delay with d.c. rectifier	[ms]
U	supply voltage	[V]
W_1	work of friction generating a brake disk wear of 1 mm	[MJ/mm]
W_{max}	maximum work due to friction for each braking	[J]

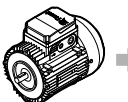
3.2

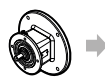
Icons

Icons	Description	Icons	Description
	refer to page		weight (without oil)
	attention		oil quantity
	breather plug		iC - 2 reduction stages
	level plug		iC - 3 reduction stages
	drain plug		iO - 3 reduction stages
	breather plug not in view (opposite side)		refer to motor section
	level plug not in view (opposite side)		refer to section motor adapters
	drain plug not in view (opposite side)		refer to section geometrical pairings
iC	iFIT helical inline gearmotor		
iO	iFIT bevel helical gearmotor		

page intentionally left blank

Product specifications

Section contents

4.1	General specifications	26
4.1.1	Gear reducer	27
4.1.2	Electric three-phase motor	28
4.2	Operational conditions	29
4.2.1	Operational ambient temperature	29
4.2.2	Installation altitude	29
4.2.3	Duty cycles	30
4.2.4	Frequency 60 Hz	31
4.2.5	Speed	31
4.2.6	Sound levels	31
4.2.7	Accessibility and heat dissipation	31
4.2.8	Weights	31
4.2.9	Reduced backlash	31
4.2.10	Low speed shaft seals	31
4.3	Surface conditions	32
4.4	Storing	33

4.1

General specifications

Helical inline gearmotors - iC

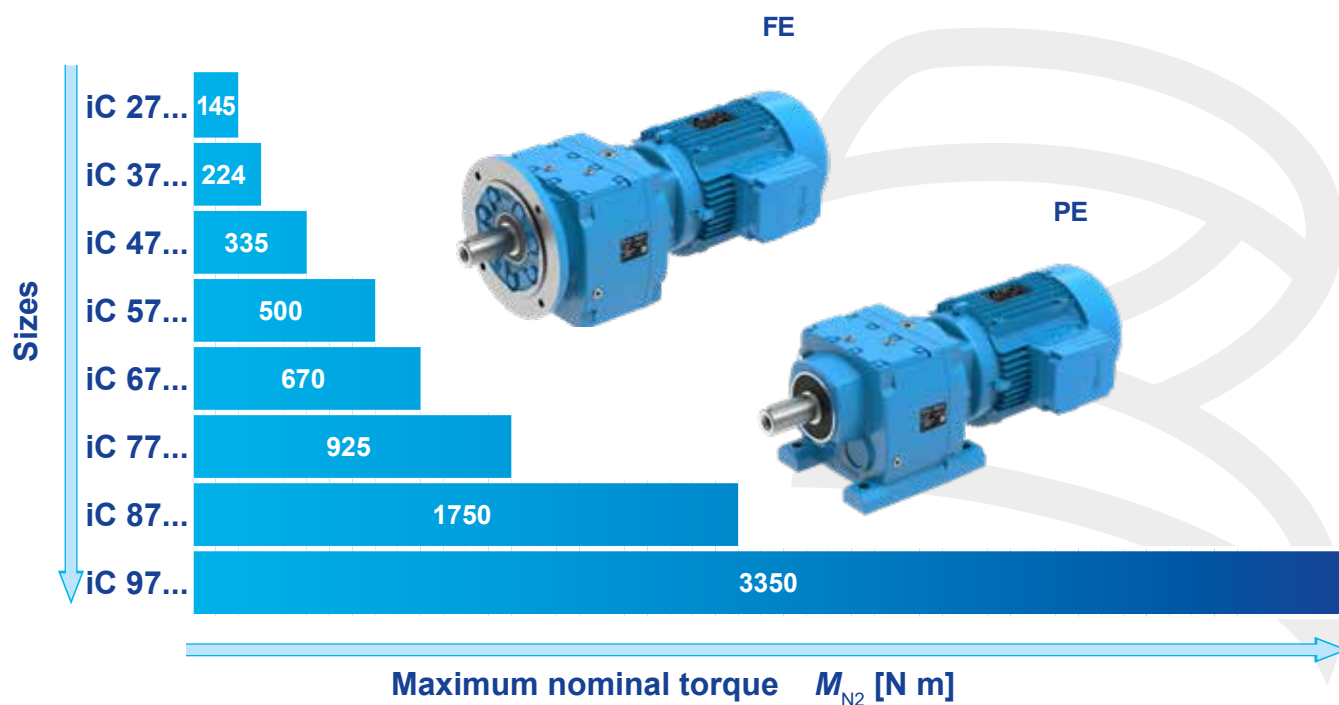

		iC 27...	iC 37...	iC 47...	iC 57...	iC 67...	iC 77...	iC 87...	iC 97...
Low speed solid shaft diameter	[mm]	25	25	30	35	35	40	50	60
Shaft height (design PE)	[mm]	90	90	115	115	130	140	180	225
B5 flange diameter (design FE)	[mm]	120...160	120...200	140...200	160...250	200, 250	250, 300	300, 350	350, 450
Maximum nominal torque	[N m]	145	224	335	500	670	925	1750	3350
Maximum nominal radial load	[N]	4230	4940	5420	7100	6980	9900	16900	19800

- **Maximum interchangeability** (shaft height, low speed shaft end, foot dimensions and fitting holes, designs), and performance equal or higher than market standards;
- **IE3, IE2 efficiency motors**;
- **foot mounting iC/iO** (foot mounted gear reducer housing), **flange mounting iC/iO** (up to 4 flanges for each gear reducer size), **shaft mounted iO**
- **gear reducer cast iron single piece housing**, high stiffness and dimensional accuracy;
- generously proportioned bearings of **low speed shaft** (bearings and shaft) in order to withstand high loads on shaft end;
- **high manufacturing quality standard**
- **high, reliable and tested performances**
- **compact motors**, under accuracy rating, also in brake version, suitable for applications with inverter.

Bevel helical gearmotors - iO

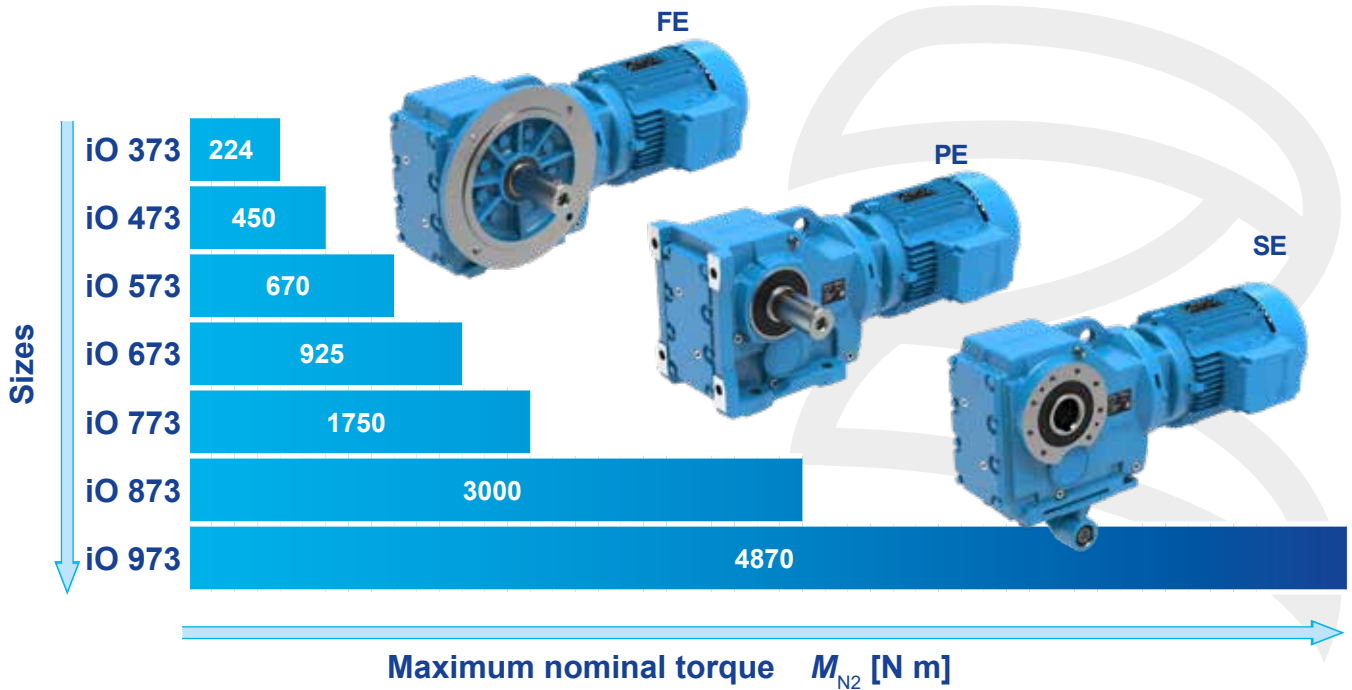

		iO 37	iO 47	iO 57	iO 67	iO 77	iO 87	iO 97
Low speed solid shaft diameter	[mm]	25	30	35	40	50	60	70
Low speed hollow shaft diameter	[mm]	30	35	40	40	50	60	70
Shaft height (design PE, SE)	[mm]	100	112	132	140	180	212	265
B5 flange diameter (design FE)	[mm]	160	200	250	250	300	350	450
Maximum nominal torque	[N m]	224	450	670	925	1750	3000	4870
Maximum nominal radial load	[N]	5640	5920	7630	12300	16100	27300	40000

4.1.1 Gear reducer

Main structural features:

- cast iron single-piece housing 250 UNI ISO 185 with stiffening ribs and high lubricant capacity;
- low speed shaft ball or tapered roller bearings (on request for sizes \geq iO 47 with hollow low speed shaft) amply sized to carry heavy loads on the low speed shaft end;
- pinion of final reduction with three bearings (sizes \geq iC 57) in order to ensure the best meshing conditions (no overhung wheel, maximum rigidity and overload capacity, maximum reduction of noise level);
- first reduction stage pinion directly fitted with interference onto the motor shaft end;
- Gleason helical spur and spiral bevel gears with ground profile for maximum load capacity, smooth operation and quietness;

- gears load capacity calculated for tooth breakage and pitting according to standard ISO;
- oil-bath lubrication; all sizes are supplied filled with polyglycol synthetic oil (PAG), "for life" lubrication;
- metal plugs (filler plug with valve; drain plug; level plug);
- paint: external coating with two-component water-based acrylic enamel appropriate for resistance to normal industrial environments (corrosivity class C3 ISO 12944-2); color blue RAL 5010 DIN 1843; internal protection with paint providing resistance to synthetic oils.

4.1.2 Electric three-phase motor

Dimensions and masses of gearmotors described in present catalog are referred to standard motor and brake motors of catalog TX.

Main structural features:

- compact motor: asynchronous three-phase, totally-enclosed, externally ventilated, with cage rotor;
- IP 55 protection, insulation class F, temperature rise class B;
- rated power delivered on continuous duty (S1) and referred to nominal voltage and frequency, ambient temperature 40 °C and maximum altitude 1 000 m.
- suitable for running with inverter (generous electromagnetic sizing, low-loss electrical stamping, phase separators, etc.);
- design available for every application need: flywheel, independent cooling fan, independent cooling fan and encoder, etc.
- paint: external protection with two-component water-based acrylic enamel appropriate for resistance to normal industrial environments (corrosivity class C3 ISO 12944-2); color blue RAL 5010 DIN 1843.

Brake motor main structural features

- particularly strong construction to withstand braking stresses; maximum reduction of noise level;
- spring-loaded d.c. electromagnetic brake; feeding from the terminal box;
- brake can also be independently fed directly from the line;
- braking torque proportioned to motor torque (usually $M_f \approx 2 M_N$);
- rapid, precise stopping;
- hand lever for manual release with automatic return; removable lever rod.

For other specifications and details see specific documentation of catalog TX.

Specific standards for electric motors:

- nominal powers and dimensions to CENELEC HD 231 (IEC 72-1, CNR-CEI UNEL 13117-71 and 13118-71, DIN 42677, NF C 51-120, BS 5000-10 and BS 4999-141) for mounting positions IM B5, IM B14 and derivatives;
- nominal performances and running specifications to CENELEC EN 60034-1 (IEC 34-1, CEI EN 60034-1, DIN VDE 0530-1, NF C51-111, BS EN 60034-1);
- protection to CENELEC EN 60034-5 (IEC 34-5, CEI 2-16, DIN EN 60034-5, NF C51-115, BS 4999-105);
- mounting positions to CENELEC EN 60034-7 (IEC 34-7, CEI EN 60034-7, DIN IEC 34-7, NF C51-117, BS EN 60034-7);
- sound levels to CENELEC 60034-9 (IEC 34.9, DIN 57530 pt. 9);
- balancing and vibration velocity (vibration under standard rating N) to CENELEC HD 53.14 S1 (IEC 34-14, ISO 2373 CEI 2-23, BS 4999-142); motors are balanced with half key inserted into shaft extension;
- cooling to CENELEC EN 60034-6 (CEI 2-7, IEC 34-6): standard type IC 411; type IC 416 for non-standard design with axial independent cooling fan.



4.2.1 Operational ambient temperature

Gear reducers

Gear reducers are suitable for operation at ambient temperature 0 °C / +40 °C (with peaks down to -20 °C / +50 °C). The operation outside this range, with a minimum of -40 °C and a maximum of +60 °C, must be evaluated in relation to the specific operating conditions, duty cycle, type of lubricant, type of seals and cooling/heating system (where possible); please contact Rossi S.p.A.

The catalog data are based on an operational ambient temperature of 25 °C (see pages 53 and 54).

Motors

HB series motors are suitable for operation in an ambient temperature range of -15°C / +40°C.

The operation outside this range is possible by adopting some precautions: contact Rossi S.p.A.

For drives with inverters, it is necessary to take into account the higher thermal stresses to which the motor windings may be subjected.

If needed, contact Rossi S.p.A.

4.2.2 Installation altitude

Installation altitude affects the effectiveness of convection heat dissipation; heat dissipation capacity decreases as installation altitude increases.

Catalog data are referred to a maximum altitude of 1000 m.

4.2.3 Duty cycles

Continuous duty (S1)

Operation at a constant load maintained for sufficient time to allow the motor to reach thermal equilibrium.

Abbr. S1

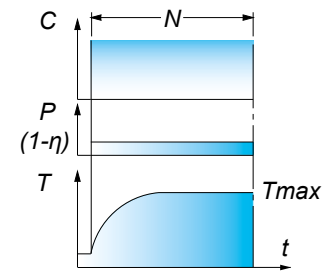

Short time duty (S2)

Running at constant load for a given period of time less than that necessary to reach normal running temperature, followed by a rest period long enough for motor's return to ambient temperature.

Abbr. S2 + time N (minimum)

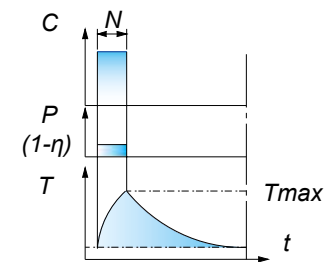

Intermittent periodic duty (S3)

Succession of identical work cycles consisting of a period of running at constant load and a rest period. Current peaks on starting are not to be of an order that will influence motor heat to any significant extent.

Abbr. S3 + cyclic duration factor

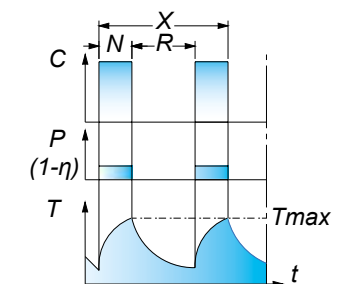

$$\text{Cyclic duration factor} = \frac{N}{N+R} \cdot 100 \text{ [\%]}$$

where

N = running time at constant load

R = rest time

For values of N+R > 10 min contact Rossi S.p.A.

In case of a duty-requirement type S2 ... S10 the motor power can be increased as per the following table; starting torque keeps unchanged.

Duty cycle			Motor size		
			63 ... 90	100 ... 132	160 ... 315
S2	duration of running	90 min	1	1	1,06
		60 min	1	1,06	1,12
		30 min	1,25	1,18	1,25
		10 min	1,25	1,25	1,32
S3	cyclic duration factor	60%	1,12		
		40%	1,18		
		25%	1,25		
		15%	1,32		
S4 ... S10			Contact Rossi S.p.A.		

4.2.4 Frequency 60 Hz

Motors up to size 132 wound for 50 Hz can be fed at 60 Hz keeping in mind the variation of nominal specifications, see specific documentation of TX series catalog.

4.2.5 Speed

Gearmotor low speed shaft rotation speeds indicated in the catalog are determined from the nominal HB motor speed under nominal operating conditions and gear reducer transmission ratio.

Actual speed may deviate from this value depending on load, actual operating conditions and power system.

4.2.6 Sound levels

The standard levels of sound power emission L_{WA} relevant to the gearmotors of this catalog, running at nominal load and speed, fulfill the limits settled by VDI 2159 for gear reducers and EN 60034 for motors.

4.2.7 Accessibility and heat dissipation

Position the gearmotor so as to allow a free passage of air for cooling both gear reducer and motor (especially at motor fan side).

Avoid any obstruction to the air-flow; heat sources near the gear reducer that might affect the temperature of cooling-air and of gear reducer for radiation; insufficient air recycle or any other factor hindering the steady dissipation of heat.

Also provide adequate spacing or shielding of heat-sensitive components (motor, brake, motor-inverter, electronic components, etc.) from hot surfaces of the driven machine, and provide adequate accessibility space for maintenance operations.

4.2.8 Weights

The weights shown in the catalog refer to gearmotors without lubricating oil.

Actual weights may vary depending on size, gearbox, transmission ratio, motor and whether there are accessories or special designs.

4.2.9 Reduced backlash

It is possible to supply the gearmotor in reduced backlash design for sizes \geq iC 37 and \geq iO 373. The values are given in paragraph 9.2 in the "Geometric Coupling Tables" and refer to the low speed shaft with locked high speed shaft.

They are valid in the absence of applied loads (max. 0,01 of the nominal load of the gear reducer), with the gear reducer at ambient temperature (25 °C) and are subject to a tolerance of ± 2 arc min.

If the value is not specified, the reduced backlash option is not available.

4.2.10 Low speed shaft seals

For aggressive environmental conditions or particularly severe operating conditions, the option "Sealing rings (gear reducer and motor) in fluoride compound" is available.

For gear reducer size \geq iC 37 with flange and size \geq iO 473 with flange and solid shaft it is possible to have the option «Double seal on low speed shaft».

4.3

Surface protection

The gearmotors are protected externally with a water-based dual compound acrylic enamel paint suitable for withstanding normal industrial environments (corrosivity class C3 ISO 12944-2; color blue RAL 5010). Other paints and protection degrees are available on request as per table below.

Field of use	Features	Corrosivity class ISO 12944-2	Durability class ISO 12944-2	Description treatment	Thickness treatment µm	Code
Applications in aggressive ambients	Good resistance to atmospheric and aggressive agents	C4	Low	1) Dual-compound epoxy primer 2) Water-soluble polyurethane dual-compound enamel with polyurethane acrylic resins	150	1HRAL5010 (blue)
			Medium	1) Dual-compound epoxy primer (2 layers) 2) Water-soluble polyurethane dual-compound enamel with polyurethane acrylic resins	200	2HRAL5010 (blue)
			High	1) Dual-compound epoxy primer (4 layers) 2) Water-soluble polyurethane dual-compound enamel with polyurethane acrylic resins	300	3HRAL5010 (blue)
Outdoor applications in saline environment	Excellent resistance to atmospheric and aggressive agents	C5 - M	Medium	1) Sanding 2) Dual-compound antirust primer with zinc phosphates 3) Dual-compound epoxy primer 4) Water-soluble polyurethane dual-compound enamel with polyurethane acrylic resins	300	2IRAL5010 (blue) 1)
	Outdoor applications in saline environment		High	1) Sanding 2) Dual-compound antirust primer with zinc phosphates 3) Sealing with polyurethane sealant 4) Dual-compound epoxy primer 5) Polyurethane dual-compound enamel with polyurethane acrylic resins	400	2KRAL5010 (blue) 1) 2)
Outdoor applications in chemically aggressive environment and high humidity industrial areas	Excellent resistance to atmospheric and aggressive agents	C5 - I	Medium	1) Sanding 2) Dual-compound antirust primer with zinc phosphates 3) Dual-compound epoxy primer 4) Water-soluble dual-compound enamel with epoxy resins	300	2LRAL5010 (blue) 1)
	Outdoor applications in chemically aggressive environment (fertilizers, etc.)		High	1) Sanding 2) Dual-compound antirust primer with zinc phosphates 3) Sealing with polyurethane sealant 4) Dual-compound epoxy enamel 5) Water-soluble dual-compound enamel with epoxy resins	400	2YRAL5010 (blue) 1) 2)

¹⁾ Available for sizes ≥ 47 .

²⁾ Not available on motors

Storage and warehousing

Rossi gearmotors must be stored in a closed environment where they are protected from solar radiation and corrosive agents. The ambient must be sufficiently clean, dry (relative humidity < 50 %), free from excessive vibrations ($v_{eff} \leq 0,2$ mm/s) to avoid damage to bearings.

Ambient temperature $0 \div 40$ °C; with peaks up to a ± 10 °C.

For different ambient conditions, contact Rossi S.p.A.

The gear units and gearmotors must be positioned according to the mounting position stated in the order and on the nameplate. **Do not stack units.**

Do not, under any circumstances, loosen the closed plugs or activate the drain plug before commissioning.

For storage periods of 12 to 24 months, we recommend requesting the "Long term storage" option, which provides:

- supply of the gearbox without oil filling;
- protection of the internal volume of the gearbox by applying VCI lubricant;
- application of a layer of special anti-corrosive oil on all unpainted external parts (shafts, feet, flanges), including galvanized components (screws, nuts, washers, eyebolts, etc.);
- application of adhesive label specific to the type of protection treatment;
- the packing with sealed VCI bag.

For longer periods please contact Rossi S.p.A.

5

Designation

Section contents

5.1	Coding	36
5.1.1	Helical inline gearmotor designation - iC	36
5.1.2	Bevel helical gearmotor designation - iO	38
5.1.3	Design and machine side - iO	39
5.1.4	Motor designation	40
5.1.5	Motor terminal block	40
5.1.6	Gear reducer options coding	41
5.1.7	Motor options coding	41
5.1.8	Helical inline designation examples - iC	42
5.1.9	Bevel helical designation examples - iO	43
5.2	Nameplate data	44
5.2.1	Gear reducer nameplate	44
5.2.2	Motor nameplate	44

5.1

Coding

5.1.1 Helical inline gearmotor designation - iC

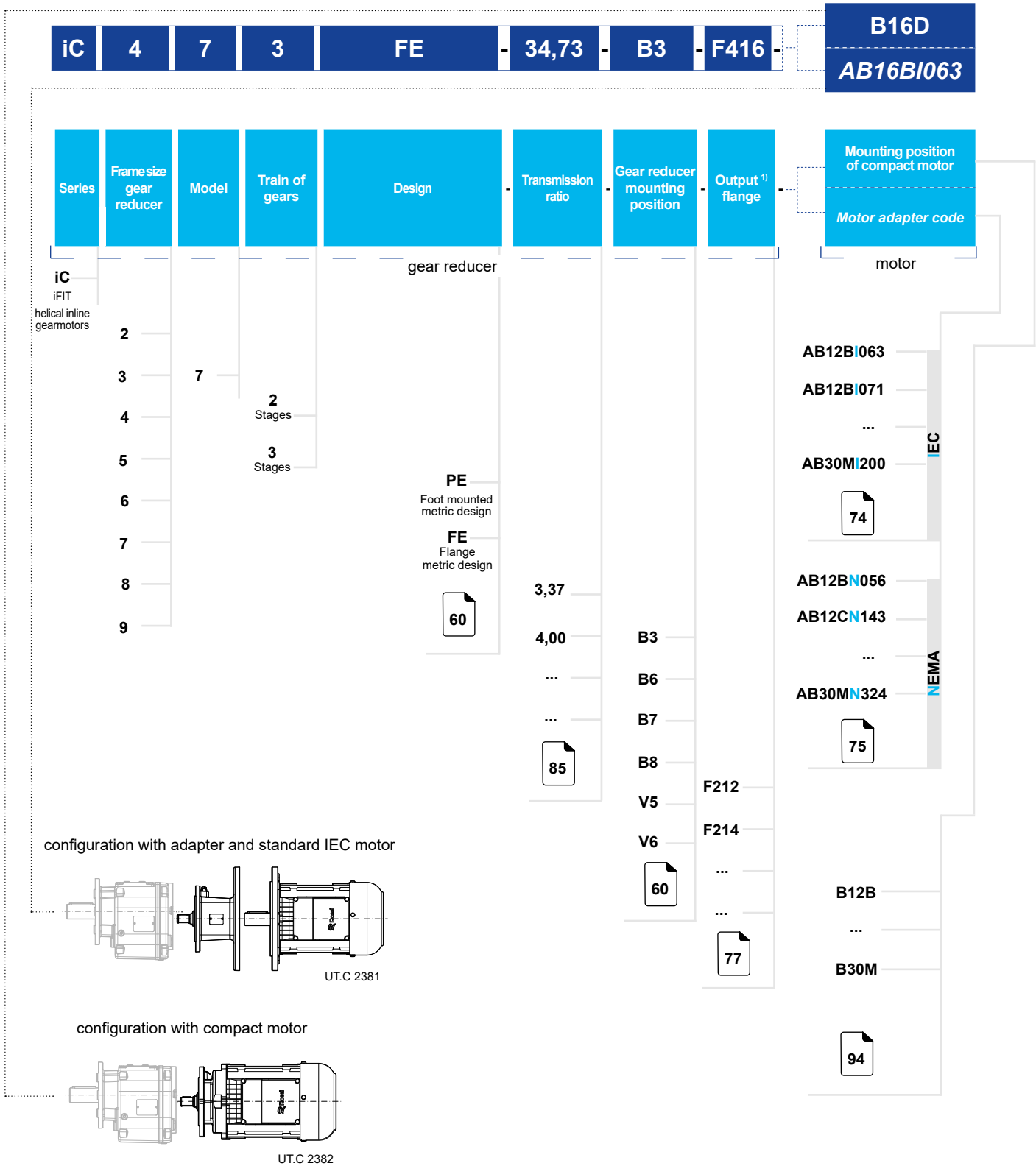

¹⁾ field to be filled in for execution with "FE" flange only

page intentionally left blank

5.1.2 Bevel helical gearmotor designation - iO

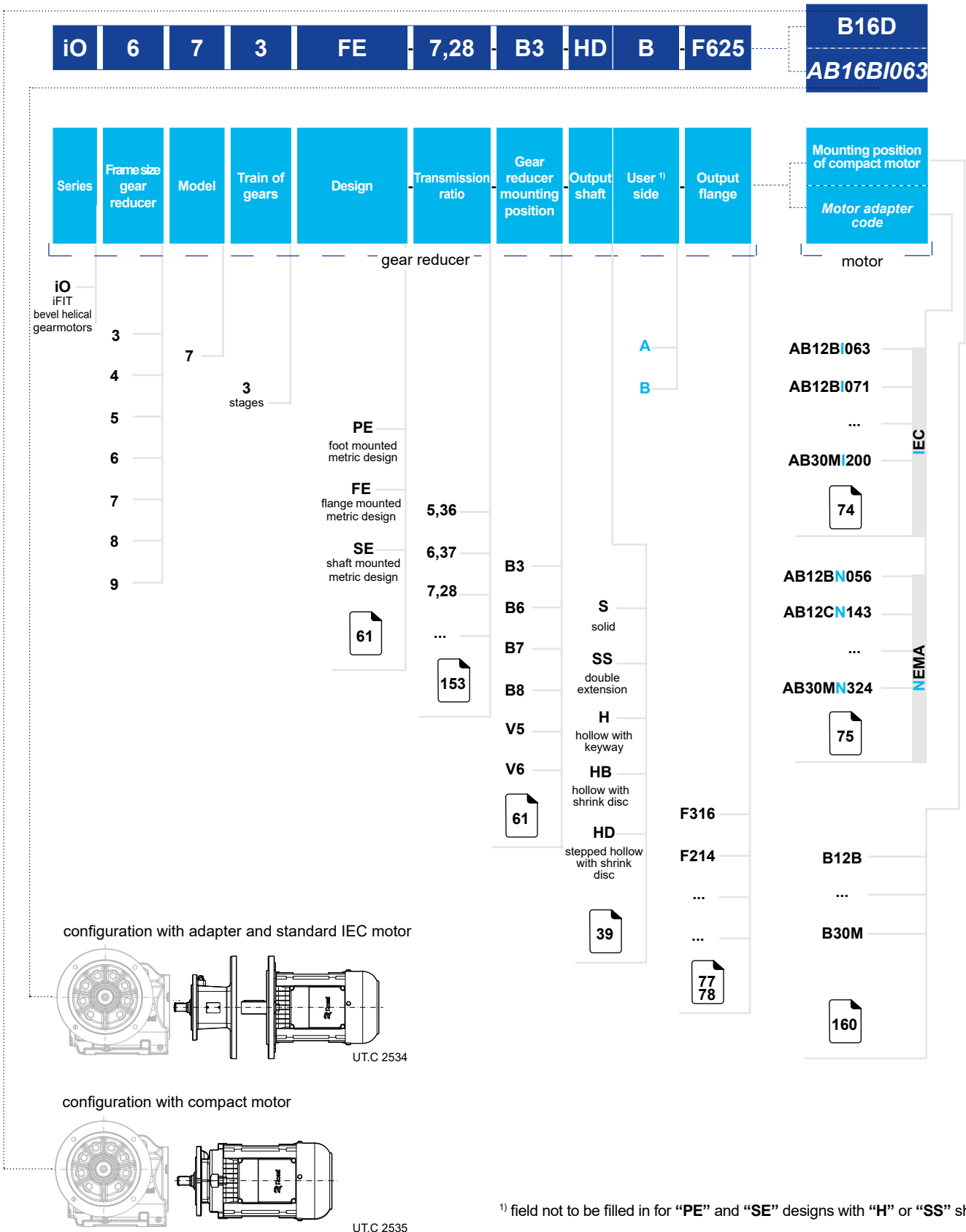

5.1.3 Design and machine side iO

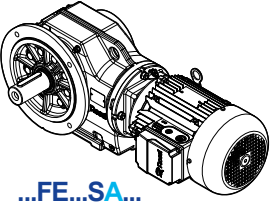
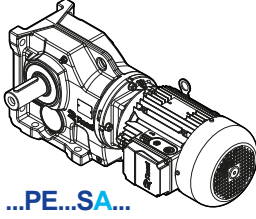
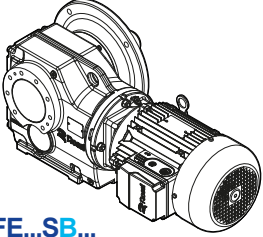
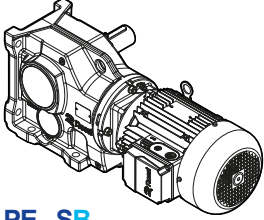
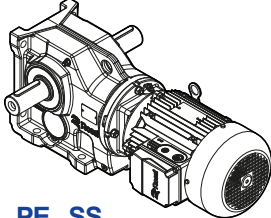
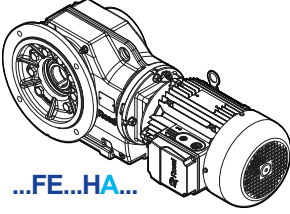
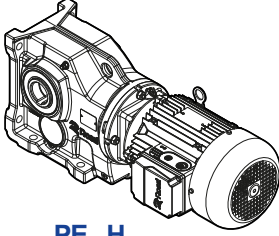
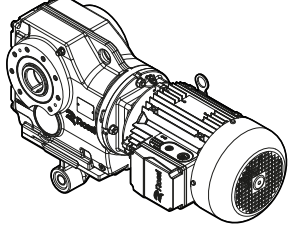
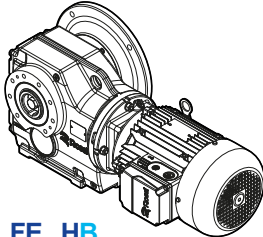
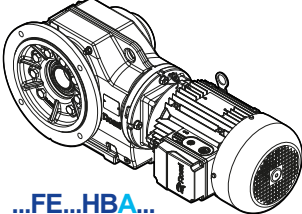
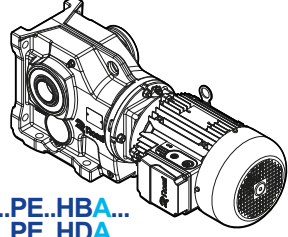
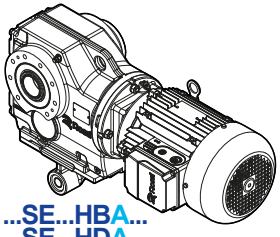
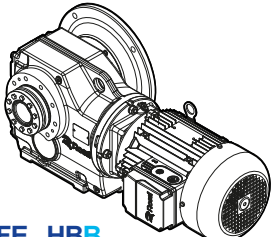
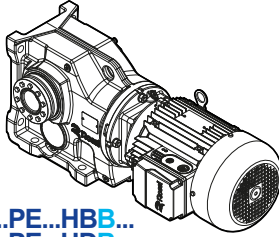
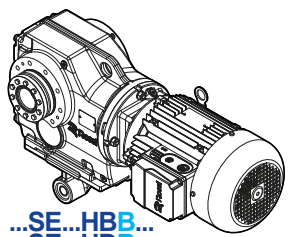
	Flange mounted design	Foot mounted design	Shaft mounted design
Solid shaft	 <p>...FE...SA...</p>	 <p>...PE...SA...</p>	-
	 <p>...FE...SB...</p>	 <p>...PE...SB...</p>	-
Double extension shaft	-	 <p>...PE...SS...</p>	-
Hollow shaft	 <p>...FE...HA...</p>	 <p>...PE...H...</p>	 <p>...SE...H...</p>
	 <p>...FE...HB...</p>		
Hollow shaft with shrink disc	 <p>...FE...HBA... ...FE...HDA...</p>	 <p>...PE...HBA... ...PE...HDA...</p>	 <p>...SE...HBA... ...SE...HDA...</p>
	 <p>...FE...HBB... ...FE...HDB...</p>	 <p>...PE...HBB... ...PE...HDB...</p>	 <p>...SE...HBB... ...SE...HDB...</p>

UT.C.2536

5.1.4 Motor designation

HB	3	Z	90S	4	230.400	50	B16D	TB2 ¹⁾
----	---	---	-----	---	---------	----	------	-------------------

Series	Energy class	Integrated brake	Motor size	N. poles	Supply voltage	Frequency	Motor mounting position		Terminal box position
							compact	IEC	
HB	2 efficiency IE2	-	63A	2	230.400	50	B12B	B5	TB1
	3 efficiency IE3	Z	63B	4	400	60	...		TB2
			71B	6	...	B30C		TB3	
			...						

5.1.5 Motor terminal block

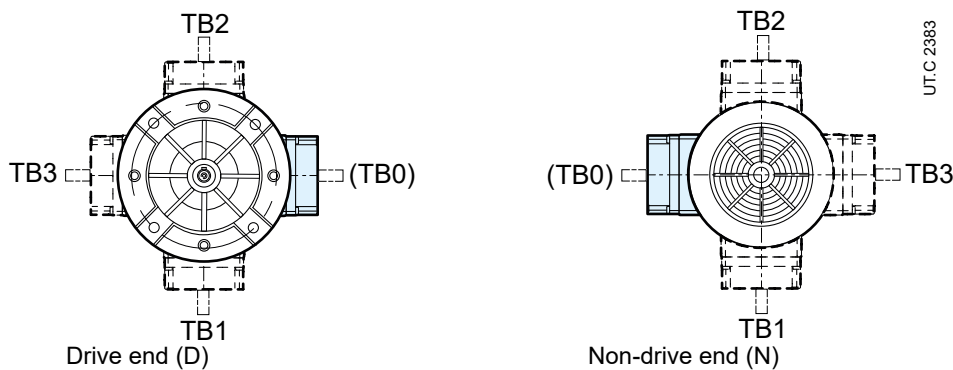

The designation is to be completed with the statement of motor terminal box position if differing from the standard one TB0 (see also pages 64, 65 for helical inline iC and pages 66,67,68 for bevel helical iO).

The release lever (for brake motor) follows the position of the terminal box.

The cable entry is the responsibility of the Buyer: the terminal box is integral with housing with knockout cable openings on both sides (one for power cable and one for auxiliary equipment).

¹⁾For standard terminal box position TB0, no indication in motor designation is necessary.

5.1.6 Gear reducer options coding

Ref.	Description	Code	Gearmotor size	
			iC	iO
(1)	Strengthened low speed shaft bearings	SP2	≥ iC 47...	≥ iO 473 H, HB, H
(2)	Low speed shaft double seal (only for design with flange)	DT2	≥ iC 37...FE	≥ iO 473 FE...S
(3)	Seal rings (gear reducer and motor) in fluoro rubber	TV2	all	all
(4)	Special painting cycle (gear reducer and motor)	pag. 32	all	all
(5)	Reduced backlash	GR	pag. 31	pag. 31
(6)	Universal mounting position	BX	all	all
(7)	Stainless steel nameplate (gear reducer and motor)	NP316	all	all
(9)	Prearranged for "long-term storage"	LS	all	all
(10)	Terminal box position differing from TB0	TB1, TB2, TB3	all	all
(11)	Torque arme	TA	–	SE
(12)	Hollow low speed shaft washer	R	–	H

5.1.7 Motor options coding

Ref.	Description	Code	HB	HBZ
(1)	Special motor supply	–	•	•
(3)	Motor insulation class H	,H	•	•
(8)	Condensate drain holes	,CD	•	•
(9)	Additional windings impregnation	,SP	•	•
(13)	Anti-condensation heater	,S	•	•
(16)	Second shaft end	,AA	•	•
(17)	Axial independent cooling fan	,V ...	•	•
(18)	Axial independent cooling fan and encoder	,V ... ,E...	•	•
(19)	Thermistor type thermal probes (PTC)	,T15 ,T17	•	•
(20)	Bi-metal thermal probes	,B15 ,B17	•	•
(21)	Drip-proof cover	,PP	•	•
(25)	Manual release lever position different from standard position (L)	,L1 ,L2 ,L3	–	•
(26)	D.c. brake separate supply	...	–	•
(35)	Light alloy fan	,VL	•	•
(36)	Encoder	,E1 ... ,E5	•	•
(42)	Motor certified to UL	,UL	•	•
(47)	Design for damp and corrosive environment, stainless steel bolts and screws of brake disk	,UC ,DB	– –	• •
(48)	IP 56 protection	,IP 56	–	•
(49)	IP 65 protection	,IP 65	–	•
(51)	Strengthened design for supply from inverter (sizes 160 ... 200)	,IR	•	•
(61)	Manual rotation	,MM	–	•
(62)	Prearranged for encoder	,PE	•	•
(63)	Axial independent cooling fan and prearranged for encoder	,V... ,PE	•	•
(64)	IP 66 protection	,IP 66	•	–

For a complete motor options description see cat. TX motors of series HB.

5.1.8 Helical inline designation examples - iC

Example 1: compact gearmotor

iC	4	7	3	FE	-	34,73	-	B3	-	F416	-	B16D
----	---	---	---	----	---	-------	---	----	---	------	---	------

- helical inline gearmotor size iC 47
- 3 reduction stages
- design with flange
- metric shaft
- transmission ratio 34,73
- gear reducer mounting position B3
- output flange F416
- compact motor with mounting position B16D

Compact motor designation compatible with above coded gear reducer follows

HB	3	Z	90S	-	4	230.400	50	-	B16D	-	TB2
----	---	---	-----	---	---	---------	----	---	------	---	-----

- motor type HB, with efficiency IE3, brake type
- motor size 90S
- number of poles 4
- supply voltage 230-400 V at 50 Hz
- compact motor with mounting position B16D
- terminal box position TB2

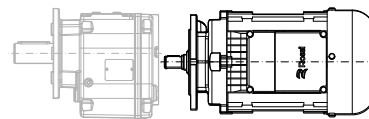

UT.C 2382

Example 2: gearmotor with IEC adapter

iC	4	7	3	FE	-	34,73	-	B3	-	F416	-	AB16DI090
----	---	---	---	----	---	-------	---	----	---	------	---	-----------

- helical inline gearmotor size iC 47
- 3 reduction stages
- design with flange
- metric shaft
- transmission ratio 34,73
- gear reducer mounting position B3
- output flange F416
- standard IEC motor with adapter AB16DI090

IEC motor designation compatible with above coded gear reducer follows

HB	3	Z	90S	-	4	230.400	50	-	B5	-	TB2
----	---	---	-----	---	---	---------	----	---	----	---	-----

- motor type HB, with efficiency IE3, brake type
- motor size 90S
- number of poles 4
- supply voltage 230-400 V at 50 Hz
- IEC motor mounting position TB2
- terminal box position TB2

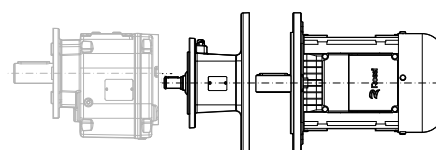

UT.C 2381

5.1.9 Bevel helical designation examples - iO

Esempio 1: bevel helical gearmotor

iO	5	7	3	FE	-	19,34	-	B3	-	SA	-	F525	-	B16D
----	---	---	---	----	---	-------	---	----	---	----	---	------	---	------

- bevel helical gearmotor size iO 57
- 3 reduction stages
- design with flange
- metric shaft
- transmission ratio 19,34
- gear reducer mounting position B3
- solid low speed shaft S in A position
- output flange F525
- compact motor with mounting position B16D

Compact motor designation compatible with above coded gear reducer follows

HB	3	Z	90S	-	4	230.400	50	-	B16D	-	TB2
----	---	---	-----	---	---	---------	----	---	------	---	-----

- motor type HB, with efficiency IE3, brake type
- motor size 90S
- number of poles 4
- supply voltage 230-400 V at 50 Hz
- compact motor with mounting position B16D
- terminal box position TB2

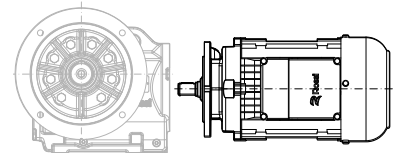

UTC 2535

Esempio 2: bevel helical gearmotor with IEC adapter

iO	4	7	3	SE	-	19,58	-	B3	-	HBB	-	AB16DI090
----	---	---	---	----	---	-------	---	----	---	-----	---	-----------

- bevel helical gearmotor size iO 47
- 3 reduction stages
- esecuzione pendolare
- metric shaft
- transmission ratio 19,58
- gear reducer mounting position B3
- hollow low speed shaft with shrink disc HB in B position
- standard IEC motor with adapter AB16DI090

IEC motor designation compatible with above coded gear reducer follows

HB	3	Z	90S	-	4	230.400	50	-	B5	-	TB2
----	---	---	-----	---	---	---------	----	---	----	---	-----

- motor type HB, with efficiency IE3, brake type
- motor size 90S
- number of poles 4
- supply voltage 230-400 V at 50 Hz
- IEC motor mounting position TB2
- terminal box position TB2

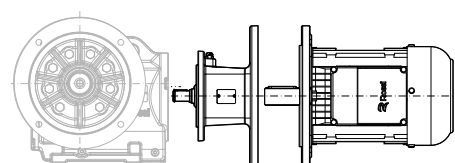

UTC 2534

5.2

Nameplate data

5.2.1 Gear reducer nameplate

Every gear reducer is provided with a name plate in anodized aluminium containing main informations necessary for a correct identification of the product.

The name plate must not be removed and must be kept integral and readable.

All name plate data must be specified on eventual spare part orders.

Rossi S.p.A.
Via Emilia Ovest, 915/A
41123 Modena (MO) - Italy
Made in Italy - www.rossi.com

Type (1)

i (2) Date (3)

M.P. (4)

Code (5)

S.N. (6)

WA (7)

ITEM (8)

- (1) Gear reducer type
- (2) Transmission ratio
- (3) Production date
- (4) Gear reducer mounting position
- (5) Product code
- (6) Serial number
- (7) Production batch
- (8) Customer code ⁽¹⁾

5.2.2 Motor nameplate

The motor is provided with a nameplate in anodized aluminium containing main information necessary for a correct identification of the project.

The name plate must not be removed and must be kept integral and readable.

All name plate data must be specified on eventual spare part orders.

Rossi IEC 60034-1 IE3 CE

MOT. (1)~ (2) (3) (4) (5) IP (6) AMB. (7) IC (8)
(9) kg (11) I.CL. (12) S (13)

(14) Frame Brake NIm V~/Hz A #/A# V-

DE/NDE (16)

(17) (18)

(19) V (19) % Hz % A kW min⁻¹ cos φ
(20) (21) (22) (23) (24) (25) (26) (27)

(28)

(29)

HB

- (1) Number of phases
- (2) Motor type
- (3) Frame size
- (4) Number of poles
- (5) Mounting position designation position
- (6) Protection IP
- (7) Ambient temperature maximum
- (8) IC code
- (9) Production batch
- (10) Two months, year of manufacturing and serial number
- (11) Motor mass
- (12) Insulation class I.CL.
- (13) Duty cycle S...
- (14) Motor code
- (15) Customer code ⁽¹⁾
- (16) Bearings
- (17) Additional note
- (18) Additional note
- (19) Connection of the phases
- (20) Rated voltage
- (21) Voltage tolerance
- (22) Nominal frequency
- (23) Frequency tolerance
- (24) Nominal current
- (25) Nominal power
- (26) Rated speed
- (27) Nominal power factor
- (28) Nominal efficiency IEC 60034-2-1
- (29) Design - code

⁽¹⁾ On request

				IEC 60034-1			
MOT. (1)~ (9)	(2) (3) (4) (5)	IP (6)	AMB. (7)	IC (8)			
(14) (15)	Brake (30)	Nm (31)	V~/Hz (32)	A (33)	### (34)	V= (35)	
DE/NDE (16)		(17)					
(19) V (19)		% (21)	Hz (22)	% (23)	A (24)	kW (25)	min ⁻¹ (26)
(20)		(27)					
(28)		(29)					

HBZ

- (1) Number of phases
- (2) Motor type
- (3) Frame size
- (4) Number of poles
- (5) Mounting position designation position
- (6) Protection IP
- (7) Ambient temperature maximum
- (8) IC code
- (9) Production batch
- (10) Two months, year of manufacturing and serial number
- (11) Motor mass
- (12) Insulation class I.CL.
- (13) Duty cycle S...
- (14) Motor code
- (15) Customer code ⁽¹⁾
- (16) Bearings
- (17) Additional note
- (18) Additional note
- (19) Connection of the phases
- (20) Rated voltage
- (21) Voltage tolerance
- (22) Nominal frequency
- (23) Frequency tolerance
- (24) Nominal current
- (25) Nominal power
- (26) Rated speed
- (27) Nominal power factor
- (28) Nominal efficiency IEC 60034-2-1
- (29) Design - code
- (30) Brake size
- (31) Braking torque
- (32) Supply of rectifier
- (33) Current absorbed by brake
- (34) Nominal d.c. voltage supply of brake
- (35) Nominal d.c. voltage of brake supply

⁽¹⁾ On request

Project Planning

Section contents

6.1	Selection	48
6.1.1	Selection data	48
6.1.2	Gearmotor size selection	48
6.1.3	Verifications	49
6.1.4	Start and stop overloads	49
6.1.5	Operation with brake motor	50
6.1.6	Considerations on motor power	50
6.2	Service factor f_s	51
6.3	Efficiency	52
6.4	Thermal power P_t	53
6.5	Radial loads on low speed shaft end	55
6.5.1	General	55
6.5.2	Determination of applied radial load	55
6.5.3	Permissible radial load	55
6.5.4	Permissible axial load	56
6.5.5	Radial load not in center line	56

6.1

Selection

6.1.1 Selection data

For a correct selection of gearmotor and drive, the following information about the application is required

Symbols	Description	Unit of Measure SI
n_{2min}	minimum rotation speed required on low speed shaft	[min ⁻¹]
n_{2max}	maximum rotation speed required on low speed shaft	[min ⁻¹]
$P_{2-n2 min}$	power required at low speed shaft at minimum speed	[kW]
$P_{2-n2 max}$	power required at low speed shaft at maximum speed	[kW]
$M_{2-n2 min}$	torque required at low speed shaft at minimum speed	[N m]
$M_{2-n2 max}$	torque required at low speed shaft at maximum speed	[N m]
F_{a2}	axial loads on low speed shaft	[N]
F_{r2}	radial loads on low speed shaft	[N]
J	external moment of inertia of mass (couplings, driven machine)	[kg m ²]
T_{amb}	(maximum and minimum) ambient temperature	[°C]
H	installation altitude	[m]
$S1, S2, \dots$	duty cycle	[%]
z	number of starts per hour	[start/h]
f	supply frequency	[Hz]
U_{mot}	motor supply voltage	[V]
U_f	brake supply voltage	[V]
M_f	braking torque	[N m]
$B3 \dots V6$	gearmotor mounting position	

6.1.2 Selection of gearmotor size

In order to select the most suitable gearmotor size for the application, you must:

- 1 have the necessary data as indicated in the previous paragraph:
 - power P_2 required at gearmotor output;
 - angular speed n_2 ,
 - operating conditions (nature of the load, duration, frequency of starting z , other considerations).
- 2 determine service factor f_s on the basis of running conditions (page 52).
- 3 select the gearmotor size on the basis of:
 - n_2
 - f_s
 - power P_1 equal or greater than P_2

If power P_2 required is the result of a precise calculation, the gearmotor should be selected on the basis of a power P_1 equal or greater than P_2 / η , where $\eta = 0,97 \div 0,98$ is gear reducer efficiency (page 52).

When for reasons of motor standardization, power P_1 available in catalog is much greater than the power P_2 required, the gearmotor can be selected on the basis of a lower service factor provided it is certain that this excess power available will never be required and frequency of starting z is low enough not to affect service factor (page 52).

Calculations can also be made on the basis of torque instead of power; this method is even preferable for low n_2 values.

6.1.3 Verifications

- Verify possible radial load F_{r2} referring to directions given on pages 55 and 56.
- For the motor, verify frequency of starting z when higher than that normally permissible, referring to directions and values given in ch. 2 cat. TX; this will normally be required for brake motors only.
- When a load chart is available, and/or there are overloads – due to starting on full load (especially with high inertias and low transmission ratios), braking, shocks, gear reducers in which the low speed shaft becomes driving member due to driven machine inertia, applied power higher than strictly required, other static or dynamic causes - verify that the maximum torque peak is always smaller than $1,6 \cdot M_{N2}$ (where $M_{N2} = M_2 \cdot fs$).
If higher or if it cannot be evaluated in the above cases, install safety devices so that $1,6 \cdot M_{N2}$ will never be exceeded.

6.1.4 Start and stop overloads

Starting torque

When starting on full load (especially for high inertias and low transmission ratios) verify that starting torque $M_{2\text{ starting}}$ is:

$$M_{2\text{ starting}} = \left(\frac{M_{\text{starting}}}{M_N} \cdot M_{2\text{ available}} - M_{2\text{ required}} \right) \cdot \frac{J_1}{J_1 + J_0} + M_{2\text{ required}} < 1,6 \cdot M_{N2}$$

where

- $M_{2\text{ required}}$ is the torque absorbed by the machine through work and frictions;
- $M_{2\text{ available}}$ is the output torque due to motor nominal power;
- J_0 is the moment of inertia (of mass) of the motor;
- J_1 is the external moment of inertia (of mass) in kg m^2 (gear reducers, couplings, driven machine) referred to the motor shaft $J_1 = J / i^2$.

When seeking to verify that starting torque is sufficiently high for starting, take into account starting friction, if any, in evaluating $M_{2\text{ required}}$.

Braking torque

In case of **stopping machines with high kinetic energy** (high moments of inertia combined with high speeds) and **with brake motors**, verify braking stress by means of the formula

$$\left(\frac{M_f}{\eta} \cdot i + M_{2\text{ required}} \right) \cdot \frac{J_1}{J_1 + J_0} + M_{2\text{ required}} < 1,6 \cdot M_{N2}$$

where

- M_f is the braking torque setting (see table on page 218)
- η is the efficiency
- i is the transmission ratio
- J_0 is the moment of inertia (of mass) of the motor;
- J_1 is the external moment of inertia (of mass) in kg m^2 (gear reducers, couplings, driven machine) referred to the motor shaft $J_1 = J / i^2$.

Attention:

Where no evaluation is possible, install safety devices which will keep values within $M_{2\text{ max}} = 1,6 \cdot M_{N2}$

6.1.5 Operation with brake motor

Starting time t_a and revolutions of motor φ_{a1}

$$t_a = \frac{(J_0 + J_1) \cdot n_1}{9.55 \cdot \left(M_{starting} - \frac{M_{2,required}}{i} \right)} \quad [s] \qquad \varphi_{a1} = \frac{t_a \cdot n_1}{19.1} \quad [rad]$$

Braking time t_f and revolutions of motor φ_{f1}

$$t_f = \frac{(J_0 + J_1) \cdot n_1}{9.55 \cdot \left(M_f + \frac{M_{2,required}}{i} \right)} \quad [s] \qquad \varphi_{f1} = \frac{t_f \cdot n_1}{19.1} \quad [rad]$$

where:

- $M_{starting}$ is the motor starting torque $\left(\frac{9550 \cdot P_1}{n_1} \cdot \frac{M_{starting}}{M_N} \right)$
- M_f is the braking torque setting of the motor (see page 218)
- φ_{a1} is the revolution of motor during starting time t_a (see page 218)
- φ_{f1} is the revolution of motor during braking time t_f (see page 218)
- J_0 is the moment of inertia (of mass) of the motor;
- J_1 is the external moment of inertia (of mass) in $kg \cdot m^2$ (gear reducers, couplings, driven machine) referred to the motor shaft.

For other symbols, see page 20 and table on page 48.

Assuming a regular air-gap and ambient humidity, and utilizing suitable electrical equipment, repetition of the braking action, as affected by variation in temperature of the brake and by the state of wear of friction surface, is approx $0,1 \cdot \varphi_{f1}$.

6.1.6 Considerations on motor power

Taking into account the efficiency of the gear reducer, and other drives – if any – **motor power** is to be as near as possible to the power rating required by the driven machine: accurate calculation is therefore recommended.

The power required by the machine can be calculated, taking into account its components:

- power due to the work to be done,
- power required to overcome friction (first detachment, sliding or rolling)
- power required to overcome inertia (especially when the mass and/or acceleration or deceleration is large);

or determined experimentally based on tests and comparisons with existing applications, amperometric and wattmetric readings.

Oversizing the motor involves:

- higher starting current and therefore larger fuse valves and conductor section;
- a higher operating cost as it worsens the power factor ($\cos \varphi$) and also the efficiency;
- greater stress on the drive, causing danger of mechanical failure, drive being normally proportionate to the power rating required by the machine, not to motor power.

Only high values of ambient temperature, altitude, frequency of starting or other particular conditions require an increase in motor power.

Service factor

Service factor f_s takes into account the different running conditions which the gearmotor must be referred to:

- nature of load;
- duration;
- frequency of starting;

and other consideration to be considered in the calculations of gear reducer selection and verification.

For a quick and rough selection, the following table gives the minimum service factor f_s required according to the kind of the driven machine.

Load classification		Driven machine	$f_s \geq$
I	Uniform load ($m_j \leq 0,3$)	Fans (small diameters) Agitators (liquids at low and constant density) Mixers (low density and uniform materials) Belt conveyors (fine grade loose materials) Auxiliary commands Assembly lines Filling machines Compressors Centrifugal pumps (liquids with low and constant density) Elevators Escalations	1
II	Moderate overloads ($m_j \leq 3$)	Fans (average diameters) Agitators (liquids, high or variable density) Mixers (variable density materials) Belt conveyors (coarse bulk materials) Translations Dosing pumps Gear pumps Multi-cylinder piston pumps Centrifugal Pumps (high or variable density liquids) Palletizers Slewing gears Palletizing equipments Bottling machines Hoists Sliding doors	1.32
III	Heavy overloads ($m_j \leq 10$)	Bucket elevators Roller ways Heavy duty mixers (solid and heterogeneous materials) Bridge crane translations Mechanisms (cranks, eccentrics) Shears (sheet metal) Bending rolls Centrifuges Presses (crank, toggle, eccentric)	1.6

For a more accurate calculation of the required service factor (especially considering the running hours), proceed as stated below

- 1) Calculate the mass acceleration factor m_j :

$$m_j = \frac{J_1}{J_0}$$

where:

- J_1 [kg m²] is the external moment of inertia J (of mass; coupling, driven machine), referred to motor shaft $J_1 = J / i^2$;
- J_0 [kg m²] is the moment of inertia (of mass) of motor (see. cat. TX) including brakes, flywheel, etc.
- i is the transmission ratio of selected gear reducer.

- 2) Select the proper overload class according to the acceleration mass factor m_j

$m_j \leq 0,3$ (uniform) **class I**

$m_j \leq 3$ (moderate overloads: $\approx 1,6$ x normal) **class II**

$m_j \leq 10$ (heavy overloads: $\approx 2,5$ x normal) **class III**

For m_j values higher than 10, in presence of high values of backlash for kinematic chain and/or high radial loads a specific evaluation has to be carried out: contact Rossi S.p.A.

- 3) From the diagram below, according to the overload class, the running time and the starting frequency z , read off the service factor required.

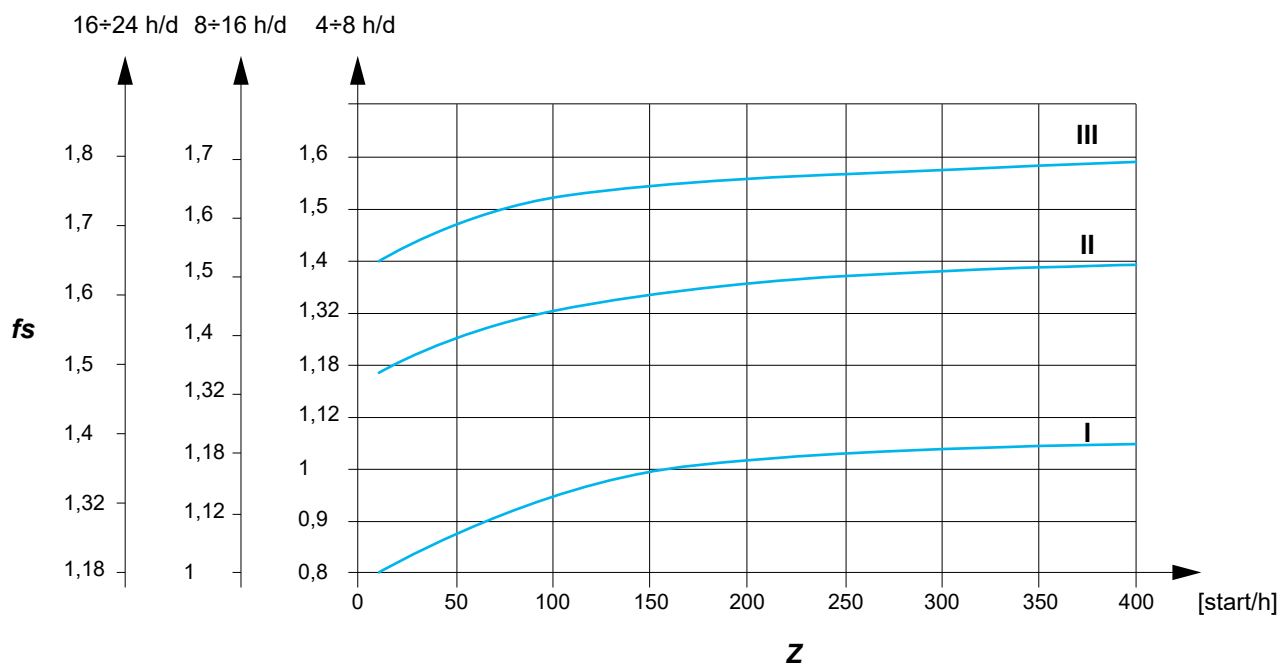

6.3

Efficiency

Gear reducer efficiency is determined by the friction of the sliding and rolling surfaces (gears, bearings and seals) and by the oil splash leakage of the lubricating oil.

The value of efficiency is influenced by operating conditions (load and speed) and can reach a maximum value up to

- maximum efficiency 0,97 (for 3 stages iC and iO gear reducers)
- maximum efficiency 0,98 (for 2 stages iC gear reducers).

The power loss due to efficiency is dissipated as heat flow through the outer surfaces of the gearmotor.

In order not to overheat the lubricant and seal material, **it must be ensured that the power applied does not exceed the heat dissipation capacity of the gearmotor.**

Thermal power

The nominal thermal power P_{TN} [kW] is that which can be applied at the gear reducer input, without exceeding 95 °C approximately oil temperature when operating in following running conditions:

- input speed $n_1 = 1400 \text{ min}^{-1}$ (4 poles motor, 50 Hz);
- mounting position B3, B6, B7, B8;
- continuous duty S1;
- maximum ambient temperature 25 °C;
- maximum altitude 1000 m a.s.l.
- air speed $\geq 1,25 \text{ m/s}$ (typical value in presence of a gearmotor with self-cooled motor)

The gearmotor combinations shown in chapters 9 and 11 are already thermally verified for all of the above conditions, including 2-pole combinations.



Otherwise it is necessary to verify that the applied power P_1 is less than or equal to the gearbox rated thermal power P_{TN} (indicated in the table) multiplied by the corrective coefficients $f_{T1}, f_{T2}, f_{T3}, f_{T4}, f_{T5}$ (indicated in the tables) that take into account the different operating conditions:

$$P_1 \leq P_{TN} \cdot f_{T1} \cdot f_{T2} \cdot f_{T3} \cdot f_{T4} \cdot f_{T5}$$

If verification is not met, evaluate the use of special lubricants or heat exchanger cooling units, contact Rossi S.p.A.



Thermal power needs not be taken into account when maximum duration of continuous running time is $1 \div 3 \text{ h}$, for all gear reducer sizes, followed by rest periods long enough to restore the gear reducer to near ambient temperature. In case of maximum ambient temperature above 50 °C or below 0 °C, contact Rossi S.p.A.

Nominal thermal power P_{TN} [kW]:

	P_{TN} [kW]							
	iC 27...	iC 37...	iC 47...	iC 57...	iC 67...	iC 77...	iC 87...	iC 97...
	7,5	8	10,6	12,5	15	20	28	40
	5,3	6	8,5	9,5	11,2	15	21,2	30

	P_{TN} [kW]							
	iO 373	iO 473	iO 573	iO 673	iO 773	iO 873	iO 973	
	5,6	7,5	9	10,6	15	25	33,5	

Thermal factor f_{T1} , according to input speed n_1 :

	f_{T1}						
	$n_1 [\text{min}^{-1}]$						
	710	900	1120	1400	1800	2800	
	1,18	1,12	1,06	1	0,85	0,6	
	1,06	1,06	1,03	1	0,95	0,85	
							

Thermal factor f_{T2} according to ambient temperature and service

$T_{amb\ max}$ °C	f_{T2}				
	Continuous duty S1	Intermittent duty S3 ... S6			
		Cyclic duration factor [%] for 60 min running			
		60	40	25	15
60	0,5	0,6	0,67	0,8	0,85
50	0,63	0,75	0,85	1	1,06
40	0,8	0,95	1,06	1,18	1,32
30	0,95	1,12	1,25	1,4	1,6
25	1	1,18	1,32	1,5	1,7
10	1,18	1,4	1,6	1,8	2

Thermal factor f_{T3} according to mounting position:

Mounting position	f_{T3}		Mounting position	f_{T3}
	iC 272 ... iC 972	iC 273 ... iC 973		iO 373 ... iO 973
V5	0,8	0,9	B6, V5	0,9
V6	0,71	0,8	B7, B8, V6	0,8

Thermal factor f_{T4} according to altitude:

Altitude	f_{T4}
≤ 1000	1
1000 ÷ 2000	0,95
2000 ÷ 3000	0,9
3000 ÷ 4000	0,85
≥ 4000	0,8

Thermal factor f_{T5} according to cooling air speed on housing:

Air speed m/s	Installation environment	f_{T5}
< 0,63	very small environment or without air movements or with protected gear reducer	(¹)
0,63	very small environment and with limited air movements	0,71
1	wide environment without air movements	0,9
1,25	wide environment with light air movements (e.g. gearmotor with self-cooled motor)	1
2,5	open and cooled	1,18
4	with heavy air movements	1,32

(¹) Contact Rossi S.p.A.

6.5.1 General

Radial loads generated on the shaft end by a drive connecting gearmotor and machine must be less than or equal to those given at ch. 9 and 11 as bearing life and wear (which also affects gears unfavourably) and low speed shaft strength clearly impose limits on permissible radial load.

6.5.2 Determination of the applied radial load

For the most common drives, radial load F_{r2} can be determined using the following formula where k takes on different values in relation to transmission type

$$F_{r2} = k \cdot \frac{2 \cdot M_2}{d} \quad [\text{N}]$$

where:

- M_2 [N m] is the torque required by the gearmotor low speed shaft;
- d [m] is the pitch diameter;
- k is a coefficient which assumes different values according to transmission type:
 - $k = 1$ for chain drive (lifting in general);
 - $k = 1,5$ for timing belt drive;
 - $k = 2,5$ for V-belt drive;
 - $k = 1,1$ for spur gear pair drive;
 - $k = 3,55$ for friction wheel drive.

6.5.3 Permissible radial load

The values of permissible radial load F_{r2} are indicated in the tables of ch. 9 and are valid for foot mounted gearmotor design (P...).

These values are referred to gearmotor's output speed n_2 and torque M_2 , considering overhung load acting on centre line of low speed shaft end, on A side (for iO gearmotors), in the most unfavorable direction of rotation and angular position of load.

If the exact direction of rotation and angular position of load are known, an increase of permissible radial load may be achieved.

On request, the option with strengthened bearings on low speed shaft is available (see page 41).

For the verification of each specific case contact Rossi S.p.A. with the notation shown in the figure.

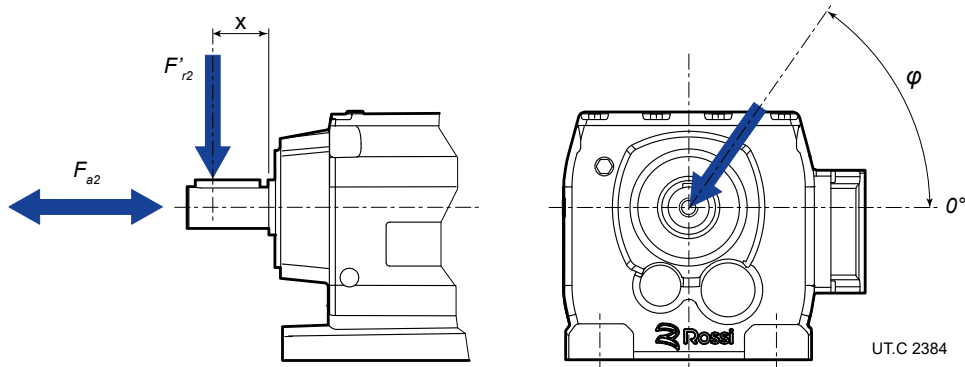

6.5.4 Permissible axial load

In absence of the radial load, an axial load may be acting on center line, not higher than 0,5 times the radial load stated in ch. 9. An **axial load** of up to 0,2 times the value in the table is permissible, simultaneously with the radial load, see ch. 9 and 11.

If exceeded and/or for **misaligned axial loads**, contact Rossi S.p.A.

6.5.5 Radial load not in center line

In the case of radial load acting in a position other than the centre line, i.e. at a distance from the shoulder other than $0,5 \cdot E$, you have to recalculate the permissible radial load value at distance x (F'_{r2x}) from the value given in chap. 9 and 11 using the minimum value given by the following formulae.

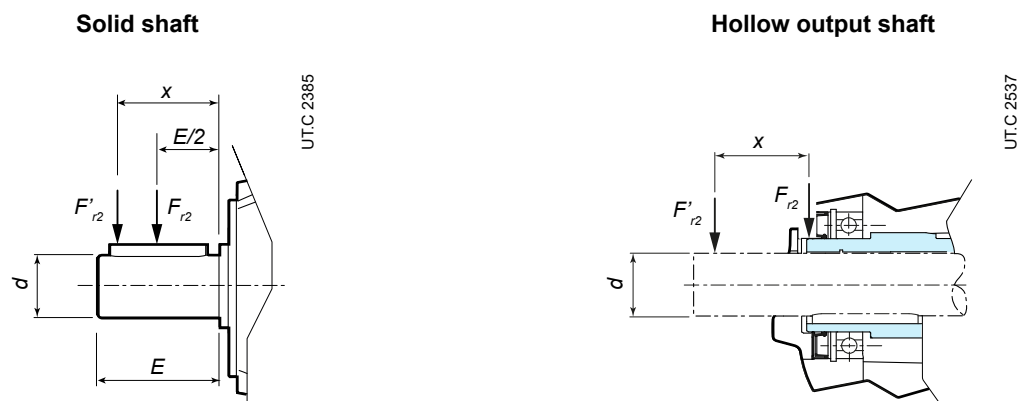

$$F'_{r2b} = F_{r2} \cdot \frac{E/2 + y}{x + y} \quad [\text{N}]$$

$$F'_{r2s} = \frac{m}{x + q} \quad [\text{N}]$$

$$F'_{r2} = \min (F'_{r2b}; F'_{r2s}) \quad [\text{N}]$$

where

- F'_{r2b} [N] is the permissible radial load, according to bearing life, acting at the distance x from shaft shoulder;
- F'_{r2s} [N] is the permissible radial load, according to shaft strength, acting at the distance x from shaft shoulder;
- F_{r2} [N] is the permissible radial load acting on center line of gearmotor low speed shaft end (see ch. 9 and ch. 11);
- F'_{r2} [N] is the permissible radial load acting at the distance x from shaft shoulder;
- E [mm] is the gearmotor low speed shaft end length;
- d [mm] diameter of gearmotor low speed shaft end;
- x [mm] is the distance between the gearmotor low speed shaft shoulder and the load application point;
- y [mm] is a parameter that depends on the geometry of the gearmotor low speed shaft;
- m [N mm] is a parameter that depends on the geometry of the gearmotor low speed shaft;
- q [mm] is a parameter that depends on the geometry of the gearmotor low speed shaft.

Gearmotor size	$E/2 + y$ mm	y mm	m N mm	q mm	d mm	E mm
iC 27...	106,5	81,5	155700	11,8	25	50
iC 37...	118	93	123500	0	25	50
iC 47...	137	107	243900	15	30	60
iC 57...	147,5	112,5	376300	18	35	70
iC 67...	168,5	133,5	264600	0	35	70
iC 77...	173,7	133,7	396800	0	40	80
iC 87...	216,7	166,7	845000	0	50	100
iC 97...	255,5	195,5	1060000	0	60	120

Gearmotor size	$E/2 + y$ mm	y mm	m N mm	q mm	d mm	E mm
iO 373	123,5	98,5	130000	0	25	50
iO 473	153,5	123,5	140000	0	30	60
iO 573	169,7	134,7	270000	0	35	70
iO 673	181,3	141,3	412000	0	40	80
iO 773	215,8	165,8	769000	0	50	100
iO 873	252	192	1640000	0	60	120
iO 973	319	249	2800000	0	70	140

The table below shows when it is necessary to limit the admissible radial load.

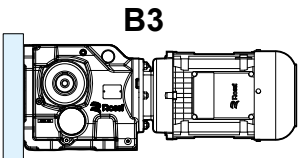
Mounting surface	Gear units	Mounting position	Restriction
 <p>B3</p>	<p>iO 373 ... iO 973</p>	<p>B3</p>	<p>In the case of wall mounting (as highlighted in Fig.), the admissible radial load Fr_2 specified in the selection tables is reduced by 50%.</p>

Mounting positions

Section contents

7.1	Mounting positions	60
7.1.1	General	60
7.1.2	Change of mounting position	62
7.1.3	Universal mounting position BX	62
7.2	Plug position	62
7.2.1	Positions of oil breather and drain plugs	62
7.2.2	Position of oil breather and drain plug of foot mounted helical inline gearmotor	64
7.2.3	Position of oil breather and drain plug of flange mounted helical inline gearmotor	65
7.2.4	Position of oil breather and drain plug of foot mounted bevel helical gearmotor	66
7.2.5	Position of oil breather and drain plug of flange mounted bevel helical gearmotor	67
7.2.6	Position of oil breather and drain plug of shaft mounted bevel helical gearmotor	68

7.1

Mounting positions

7.1.1 General

The mounting positions below show the possible mounting positions of the different gearmotor designs by Rossi S.p.A.

Except specific needs, prefer mounting position B3 as it is the most advised from a technical and economic point of view:

- maximum simplification of lubrication system,
- less oil splash,
- less gear reducer heating;
- greater availability of stock products.

For inclined or oscillating mounting positions contact Rossi S.p.A.

HELICAL INLINE GEARMOTORS - iC

PE - foot mounted design

FE - flange mounted design

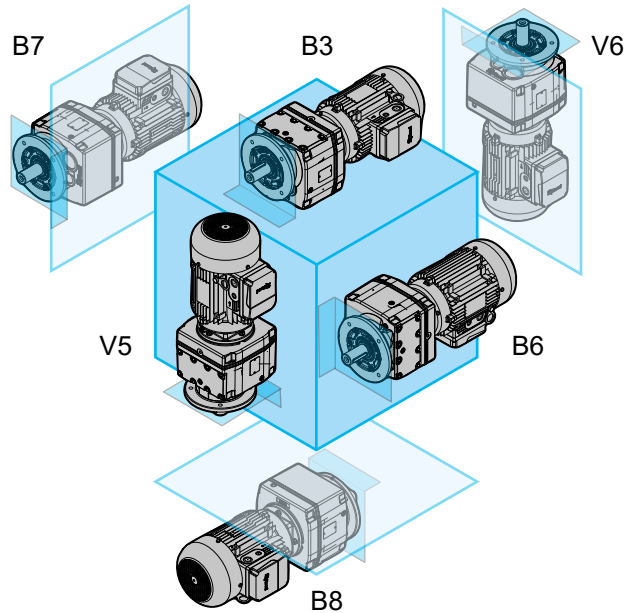
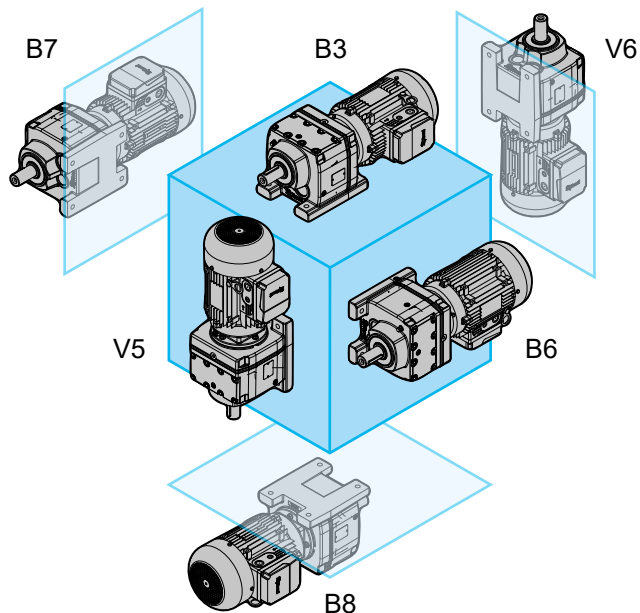

BEVEL HELICAL GEARMOTORS - iO

PE - foot mounted design

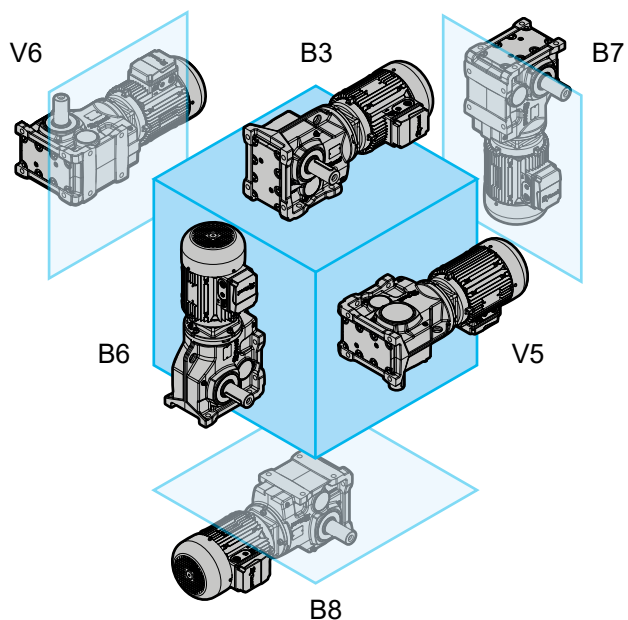

FE - flange mounted design

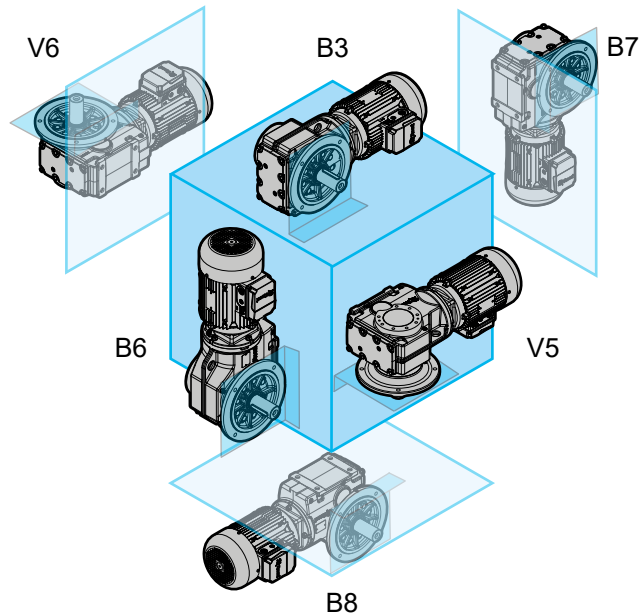

SE - shaft mounted design

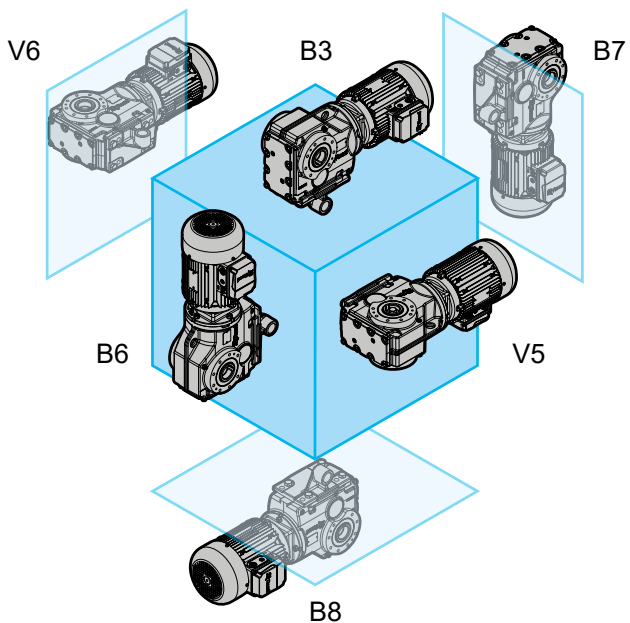

7.1.2 Change of mounting position

If gear reducer is installed in a mounting position differing from the one stated on name plate please follow these instructions:

- adjust the position of breather plug (see pages 64, 65 for helical inline iC and pages 66, 67, 68 for bevel helical iO)
- adjust lubricant quantity (see page 72) up to the oil level foreseen, checking that there are no more gas pockets in the oil which is included in the gear reducer
- for the changeover to mounting position V5 or V6 contact Rossi S.p.A.

7.1.3 Universal mounting position BX

In this mounting position the gearmotors are supplied completely full of lubricant with all closed plugs, and with a loose breather plug as standard.

Before commissioning, please follow these instructions:

- position the breather plug correctly in the position foreseen by the operation mounting position (see pages 64, 65 for helical inline iC and pages 66, 67, 68 for bevel helical iO)
- adjust oil quantity according to operation mounting position (see page 72).

7.2

Plug position

7.2.1 Positions of breather and drain plug

The position of breather and drain plug depend from gearmotor mounting position, see following pages. Following table shows when the breather or drain plugs lay on motor flange, according to gearmotor mounting position.

Mounting position		Position of breather plug	Position of drain plug
iC	iO		
B3, B6, B7, B8	B3, B8, V5, V6	in gear reducer housing	in gear reducer housing
V5	B6	in motor flange	in gear reducer housing
V6	B7	in gear reducer housing	in motor flange

When the breather plug or the drain plug are on motor flange, their angular position is determined on the basis of motor terminal box position.

All figures in this catalog represent breather and drain plugs with motor terminal box in standard TB0 position (see pages 40 and 64,65,66,67,68).

The exact position of the breather and drain plugs according to the position of the motor terminal box is shown on the next page.

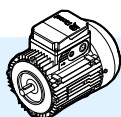
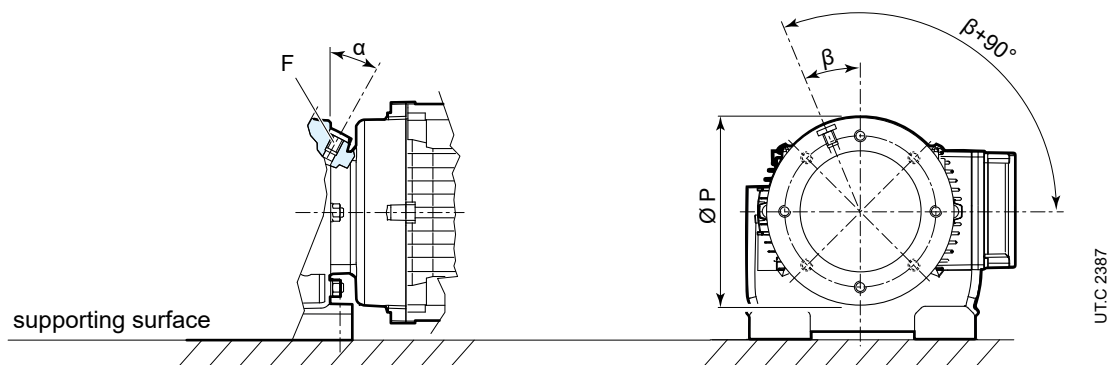

	P Ø	α °	β °	F
63	120	0	45	M10x1
	160	0	45	M10x1
	200	30	22,5	M12x1,5
71	120	0	45	M10x1
	160	0	45	M10x1
	200	30	22,5	M12x1,5
80	120	15	22,5	M10x1
	160	30	22,5	M12x1,5
	200	30	22,5	M12x1,5
	250	30	22,5	M12x1,5
	300	90	22,5	M22x1,5
90	120	30	22,5	M10x1
	160	30	22,5	M10x1
	200	30	22,5	M12x1,5
	250	30	22,5	M12x1,5
	300	30	22,5	M22x1,5
100 112MA	120	30	22,5	M10x1
	160	30	22,5	M10x1
	200	30	22,5	M12x1,5
	250	30	22,5	M12x1,5
	300	30	22,5	M22x1,5
112M	160	30	22,5	M10x1
	200	30	22,5	M12x1,5
	250	30	22,5	M12x1,5
	300	30	22,5	M22x1,5
132S 132M	160	30	22,5	M10x1
	200	15	22,5	M12x1,5
	250	30	22,5	M12x1,5
	300	30	22,5	M22x1,5
132L 160	200	30	22,5	M10x1
	250	30	22,5	M12x1,5
	300	30	22,5	M22x1,5
180	250	30	22,5	M12x1,5
	300	30	22,5	M22x1,5
200	250	30	22,5	M12x1,5
	300	30	22,5	M22x1,5

7.2.2 Position of breather and drain plug of foot mounted gearmotor

iC 27...PE / iC 97...PE

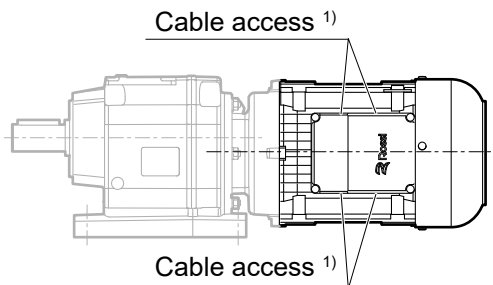
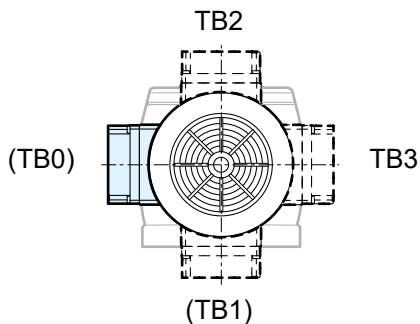
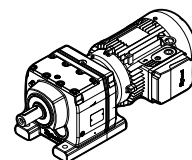

UT.C 2388

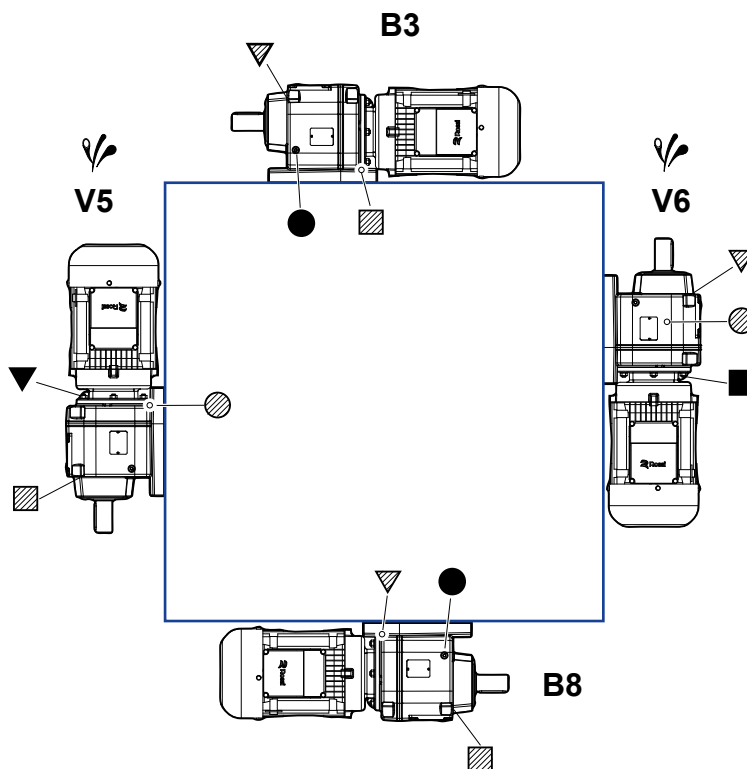

UT.C 2389

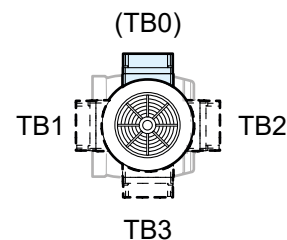
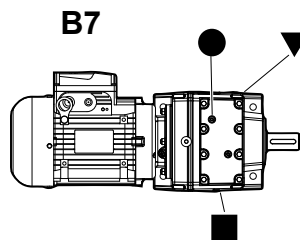
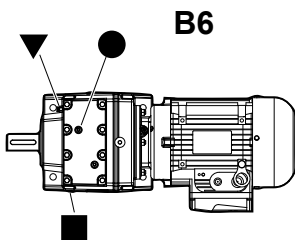
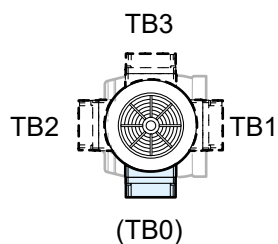

iC 27... : breather plugs not present for B3, B8, B6, B7

iC 27... : oil level and drain plugs not present

iC 47..., iC 57... : level plug not present for B6

- ▼ breather plug
- oil level plug
- oil drain plug

- ▽ breather plug on opposite side (or not in view)
- ◐ oil level plug on opposite side (or not in view)
- ◑ oil drain plug on opposite side (or not in view)

☹ Possible high oil splash: for the corrective factor f_{13} of nominal thermal power P_{TN} see page 53.

¹⁾ Cable connection is by the customer: terminal box is integral with motor housing and equipped with knockout cable openings on both sides (one for power cable and one for auxiliary equipment).

7.2.3 Position of breather and drain plug of flange mounted gearmotor

IC 27...FE / IC 97...FE

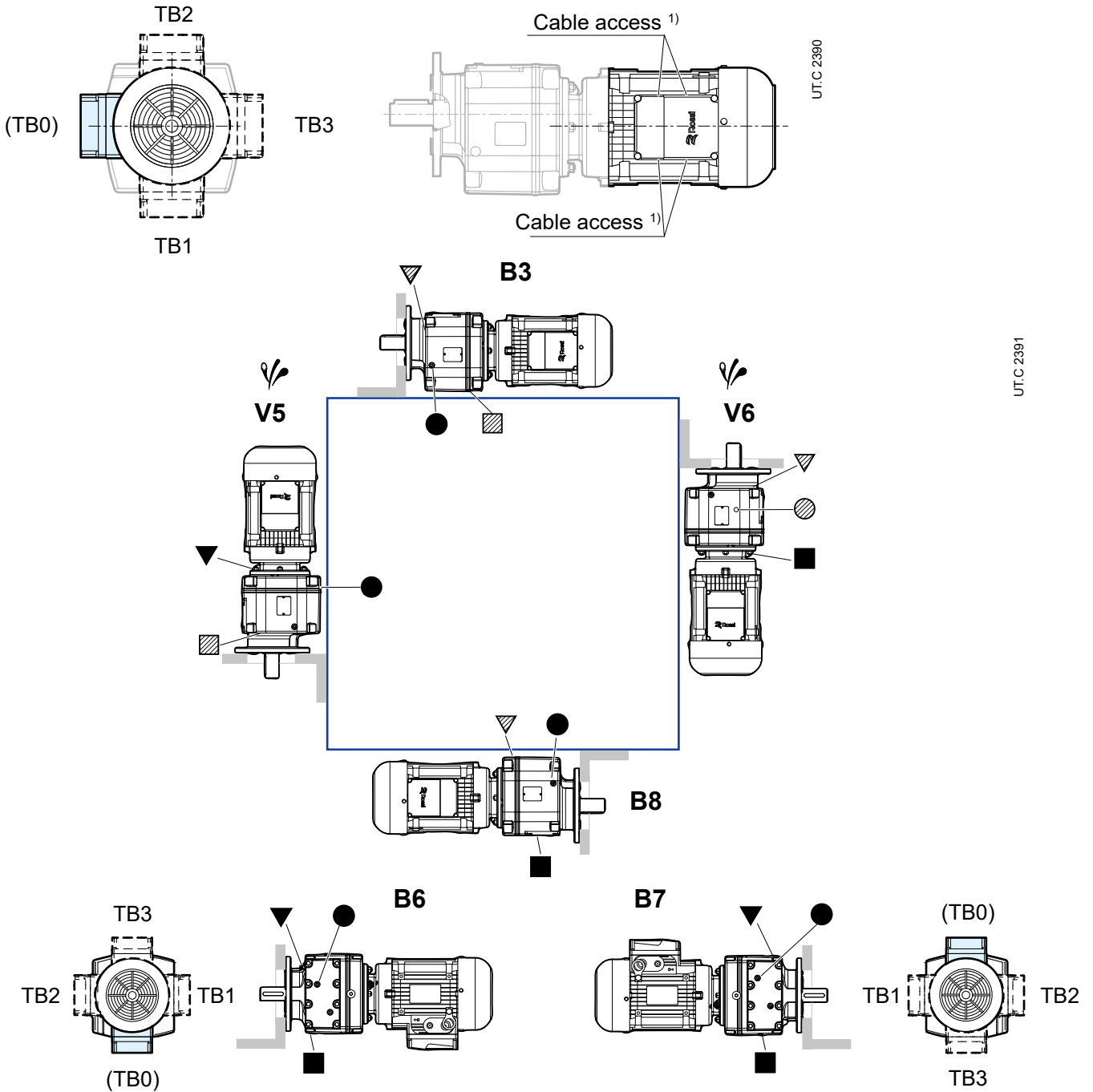
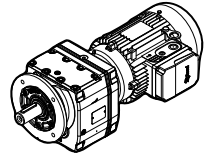

IC 27... : breather plugs not present for B3, B8, B6, B7

IC 27... : oil level and drain plugs not present

IC 47..., IC 57... level plug not present for B6

- ▼ breather plug
- oil level plug
- oil drain plug
- ▽ breather plug on opposite side (or not in view)
- oil level plug on opposite side (or not in view)
- ▨ oil drain plug on opposite side (or not in view)
- ⚡ Possible high oil splash: for the corrective factor f_{13} of nominal thermal power P_{IN} see page 53.

¹⁾ Cable connection is by the customer: terminal box is integral with motor housing and equipped with knockout cable openings on both sides (one for power cable and one for auxiliary equipment).

7.2.4 Position of breather and drain plug of foot mounted bevel helical gearmotor

iO 373 PE / iO 973 PE

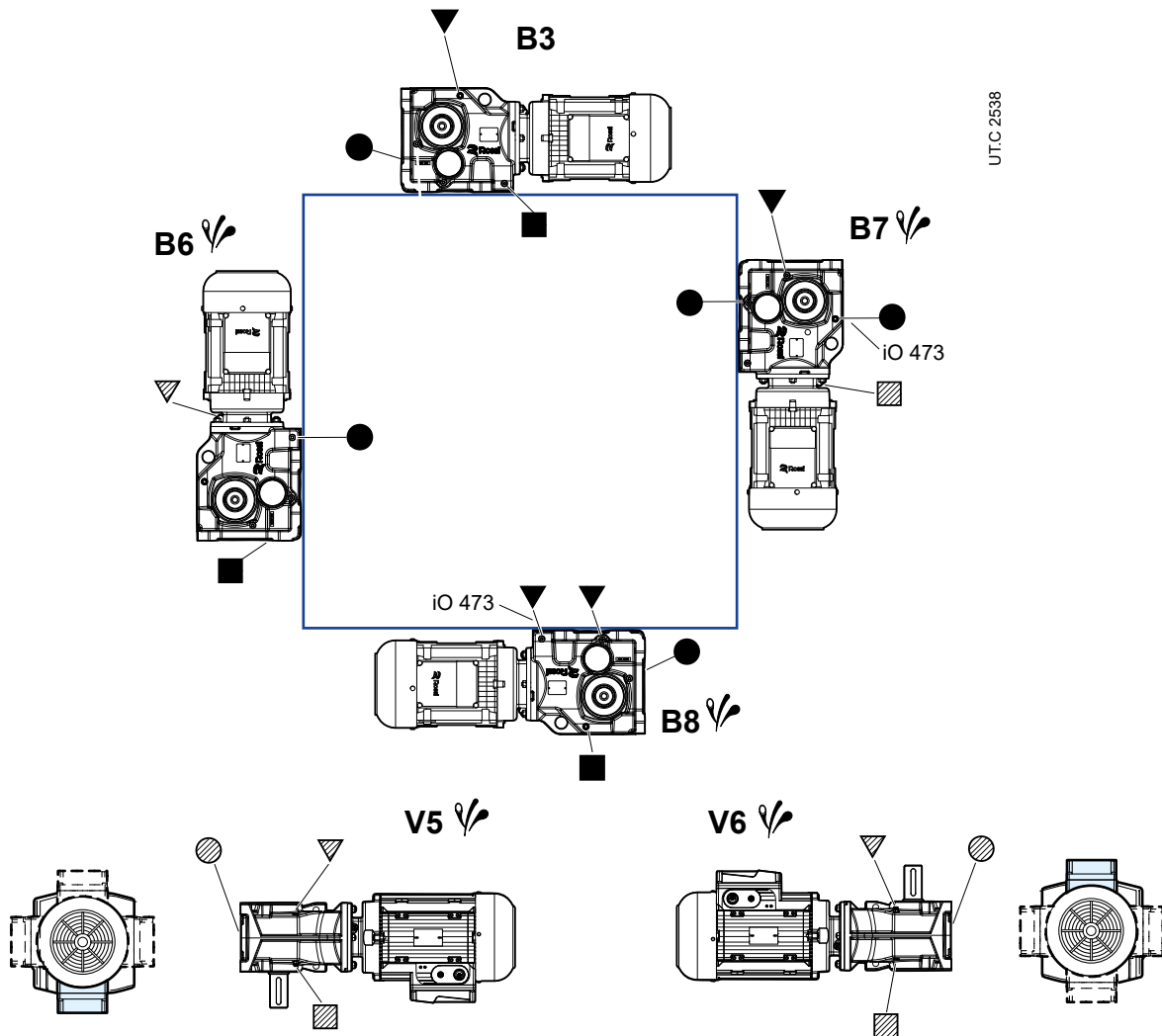
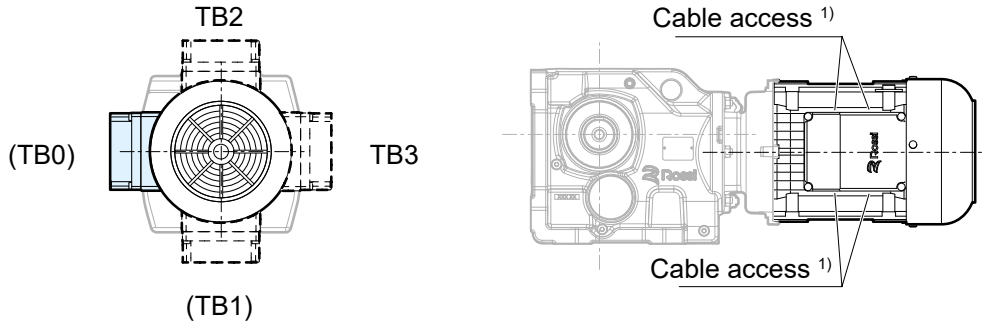
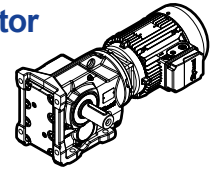

- ▼ breather plug
- oil level plug
- oil drain plug
- ▽ breather plug on opposite side (or not in view)
- ⊙ oil level plug on opposite side (or not in view)
- ▨ oil drain plug on opposite side (or not in view)
- ☼ Possible high oil splash: for the corrective factor f_{13} of nominal thermal power P_{tN} see page 53.

¹⁾ Cable connection is by the customer: terminal box is integral with motor housing and equipped with knockout cable openings on both sides (one for power cable and one for auxiliary equipment).

7.2.5 Position of breather and drain plug of flange mounted bevel helical gearmotor

iO 373 FE / iO 973 FE

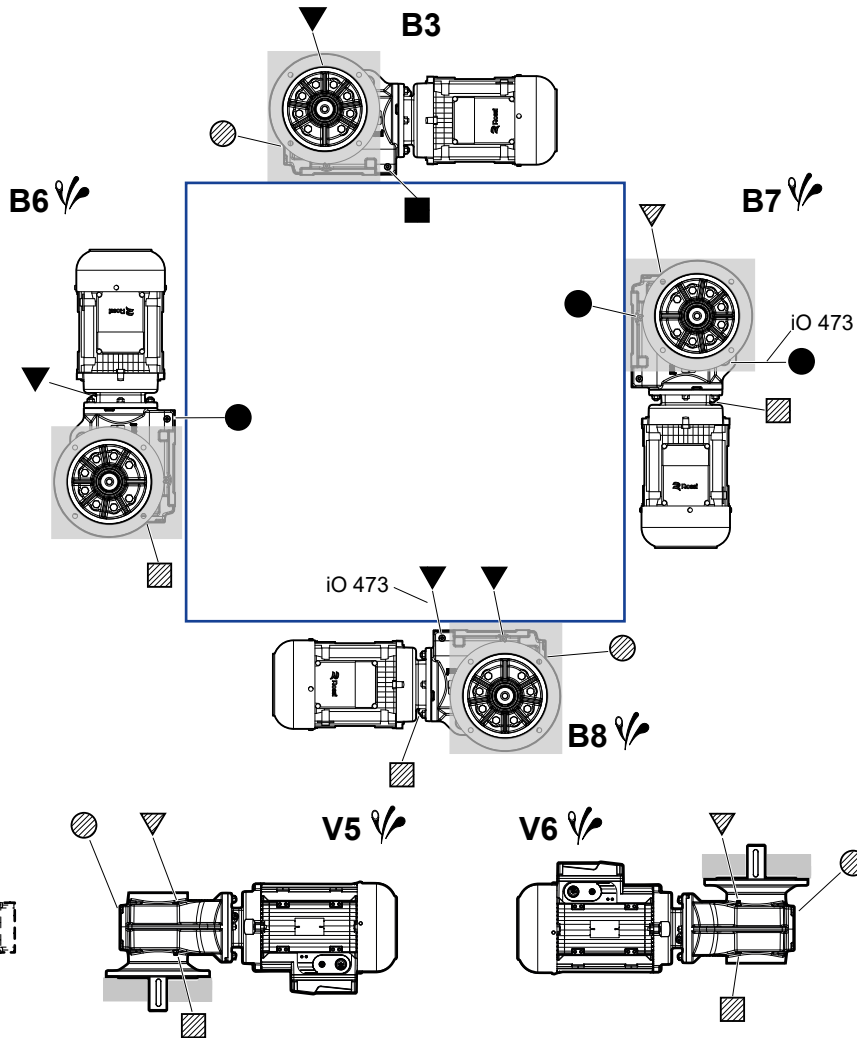
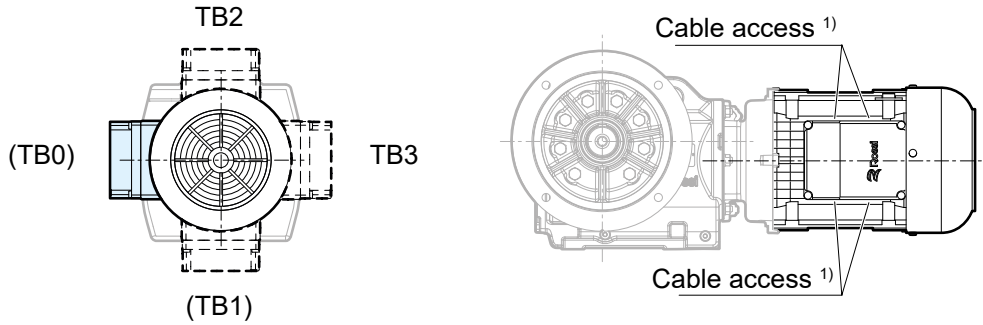
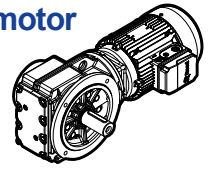

- ▼ breather plug
- oil level plug
- oil drain plug
- ▽ breather plug on opposite side (or not in view)
- oil level plug on opposite side (or not in view)
- ▨ oil drain plug on opposite side (or not in view)
- ↗ Possible high oil splash: for the corrective factor f_{13} of nominal thermal power P_{IN} see page 53.

¹⁾ Cable connection is by the customer: terminal box is integral with motor housing and equipped with knockout cable openings on both sides (one for power cable and one for auxiliary equipment).

7.2.6 Position of breather and drain plug of shaft mounted bevel helical gearmotor

IO 373 SE / IO 973 SE

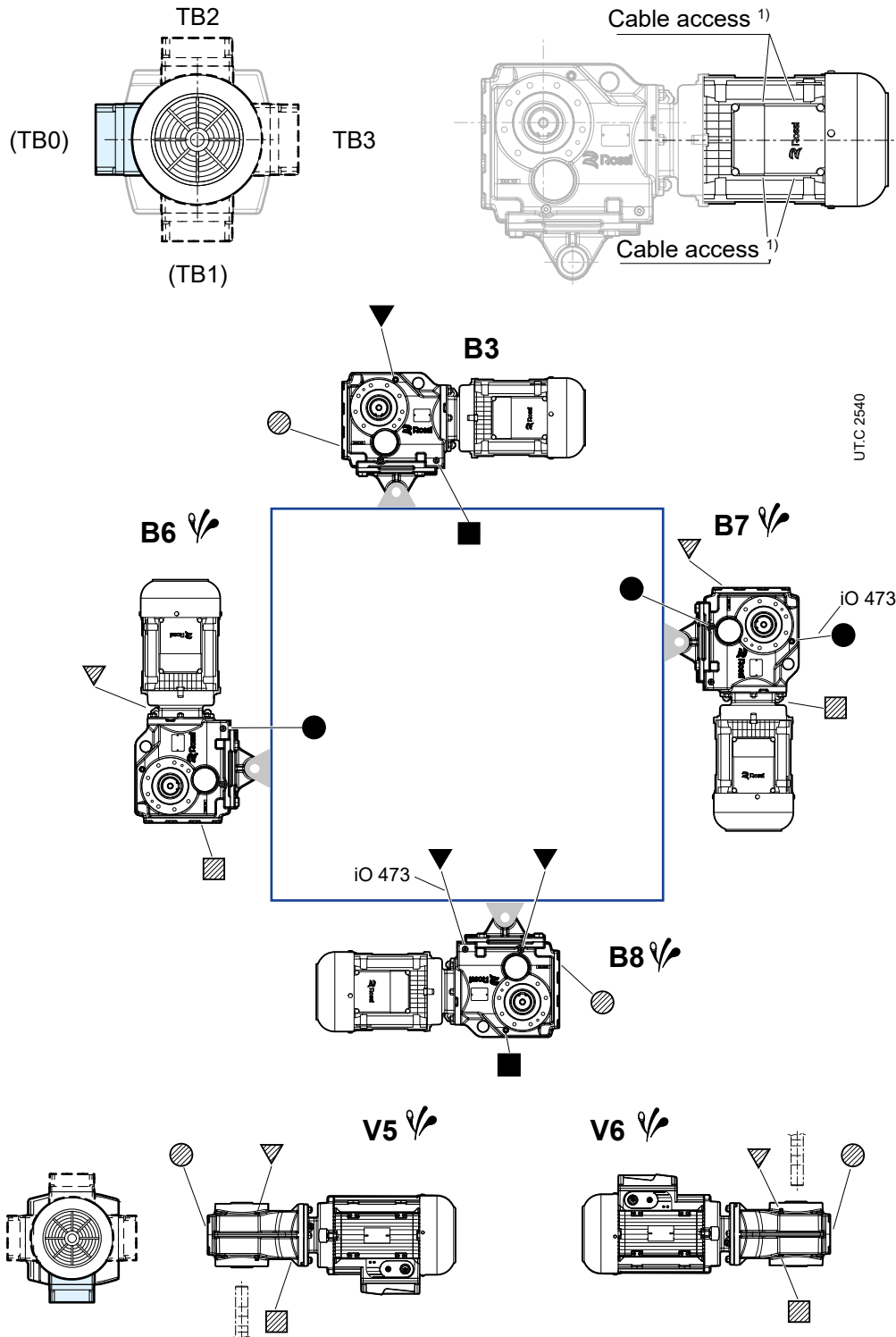
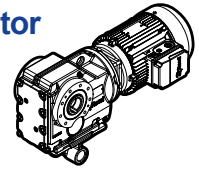

UTC 2540

- ▼ breather plug
- oil level plug
- oil drain plug
- ▼ breather plug on opposite side (or not in view)
- oil level plug on opposite side (or not in view)
- oil drain plug on opposite side (or not in view)
- ☞ Possible high oil splash: for the corrective factor f_{13} of nominal thermal power P_{tN} see page 53.

¹⁾ Cable connection is by the customer: terminal box is integral with motor housing and equipped with knockout cable openings on both sides (one for power cable and one for auxiliary equipment).

page intentionally left blank

Structural and operational details

Section contents

8.1	Lubrication	72
8.1.1	General	72
8.1.2	Oil quantity	72
8.1.3	Lubricant table	73
8.1.4	ISO viscosity grade	73
8.1.5	Oil change interval	73
8.1.6	Plug with breather	73
8.2	Motor adapters	74
8.2.1	Adapters for the assembly of standard IEC motors	74
8.2.2	Adapters for the assembly of standard NEMA C-Face motors	75
8.3	Assembling the motor (IEC or NEMA) on adapter	76
8.4	Details of gearmotor fastening flanges	76
8.5	Fastening bolts	77
8.6	Dimensional tolerances	79
8.7	Overall dimensional remarks	80
8.7.1	Overall dimensions details of HB and HBZ motors	80
8.7.2	Overall dimensions details of second motor shaft end	81

8.1

Lubrication

8.1.1 General

Gear lubrication is oil bath or splash lubrication, and bearings are splash lubricated or grease lubricated for “life” (with or without NILOS ring).

Unless otherwise stated, gearmotors are **supplied filled with synthetic oil** (KLÜBER KlüBersynth GH 6-220, MOBIL Glygoyle 220, SHELL Omala S4 WE 220), providing lubrication – assuming pollution-free surroundings – “long life”.

Ambient temperature range 0 ÷ 40 °C with peaks of -20 °C and +50 °C.

Important:

the order-specific mounting position determines the quantity of lubricant supplied to the gear unit at the time of delivery as well as whether there are bearings with independent lubrication.

Always be sure that the gearmotor is located as per the mounting position ordered, which appears on the name plate.

If the gearmotor is installed in a different mounting position verify, according to the values given in the table, that the oil quantity doesn't change; if so, adjust it consequently.

In addition, the vertical V5 and V6 mounting position requires the application of special grease in the upper bearing.

The mounting position can be changed only with previous authorization by Rossi S.p.A., otherwise the warranty is void.

8.1.2 Oil quantity

Stated lubricant quantities are approximate and indicative for provisioning. The exact quantity the gear reducer is to be filled with is definitely given by the level.

PE...; FE...						
Gearmotor size	Oil quantities [l]					
	B3	B6	B7	B8	V5	V6
iC 27...	0,45	0,6	0,6	0,55	0,9	0,8
iC 37...	0,3	0,75	0,95	0,95	1,05	0,85
iC 47...	0,7	1,5	1,5	1,5	1,65	1,6
iC 57...	0,8	1,7	1,7	1,7	2,1	1,9
iC 67...	1,1	1,8	2,0	2,8	2,9	2,4
iC 77...	1,2	2,5	3,4	3,6	3,8	3,3
iC 87...	2,3	6,3	6,5	7,2	7,2	6,4
iC 97...	4,6	11,3	11,7	11,7	13,4	11,7

PE...						
Gearmotor size	Oil quantities [l]					
	B3	B6	B7	B8	V5	V6
iO 373	0,5	1,25	1,0	1,0	0,95	0,95
iO 473	0,8	2,0	1,3	1,5	1,6	1,6
iO 573	1,1	2,8	2,2	2,2	2,3	2,1
iO 673	1,1	3,45	2,4	2,6	2,6	2,6
iO 773	2,2	5,8	4,1	4,4	4,2	4,4
iO 873	3,7	10,9	8,0	8,7	8,0	8,0
iO 973	7,0	20,0	14,0	15,7	15,7	15,5

FE...S						
Gearmotor size	Oil quantities [l]					
	B3	B6	B7	B8	V5	V6
iO 373	0,5	1,5	1,1	1,1	1,0	1,0
iO 473	0,8	2,2	1,3	1,7	1,6	1,6
iO 573	1,2	3,15	2,2	2,4	2,5	2,3
iO 673	1,1	3,7	2,4	2,8	2,7	2,7
iO 773	2,1	5,9	4,1	4,4	4,5	4,5
iO 873	3,7	11,9	8,2	9,0	8,4	8,4
iO 973	7,0	21,5	14,7	17,3	15,7	16,5

FE...H SE...H						
Gearmotor size	Oil quantities [l]					
	B3	B6	B7	B8	V5	V6
iO 373	0,5	1,4	1,0	1,0	1,0	1,0
iO 473	0,8	2,15	1,3	1,6	1,6	1,6
iO 573	1,2	3,15	2,2	2,4	2,7	2,4
iO 673	1,1	3,7	2,4	2,7	2,6	2,6
iO 773	2,1	5,9	4,1	4,6	4,4	4,4
iO 873	3,7	11,1	8,2	8,8	8,0	8,0
iO 973	7,0	20,0	14,7	15,7	15,7	15,7

8.1.3 Lubricants table

Important:

Inappropriate lubricants can cause damage to the gear reducer.

The viscosity and type of lubricating oil used for filling **are indicated on the adhesive name plate on the gear reducer.**

Rossi S.p.A. declines any responsibility for damages deriving from the use of other lubricants or from the use outside the expected ambient temperature range. The indications on lubricants do not bind Rossi S.p.A. on the quality of the lubricant supplied by each respective manufacturer. Do not mix different lubricating oils; do not mix synthetic oils with mineral oils.

Brand	Synthetic PAO oil	Synthetic PAG oil	Mineral oil	Brand	Synthetic PAO oil	Synthetic PAG oil	Mineral oil
AGIP	Blasia SX	Blasia S	Blasia	KLÜBER	Klübersynth GEM4	Klübersynth GH6	Klübersynth GEM1
ARAL	Degol PAS	Degol GS	Degol BG	MOBIL	Mobil SHC Gear	Mobil Glygoyle	Mobilgear 600 XP
BP	Energyn EPX	Energyn SG-XP	Energol GR-XP	SHELL	Omala S4 GX	Omala S4 WE	Omala S2 G
CASTROL	Alphasyn EP	Optiflex A	Alpha SP	TEXACO	Pinnacle	Synlube CLP	Meropa
FUCHS	Renolin Unisys	Renolin PG	Renolin CLP	TOTAL	Carter SH	Carter SY	Carter EP

8.1.4 ISO viscosity grade

Unless otherwise specified, the gearmotors are **supplied complete with synthetic oil** of viscosity grade ISO VG 220 suitable for most applications in normal industrial environments. For different application conditions or specific needs, please contact Rossi S.p.A.

The following table provides a general guideline for lubricant viscosity selection (average cSt value of kinematic viscosity at 40 °C).

Speed $n_2 \text{ min}^{-1}$	Ambient temperature $T_{amb} \text{ } ^\circ\text{C}$		
	Mineral Oil		Synthetic oil
	0 ÷ 20	10 ÷ 40	0 ÷ 40
> 224	150	150	150
224 ÷ 22.4	150	220	220
22.4 ÷ 5.6	220	320	320
< 5.6	320	460	460

Ambient temperature peaks of $\pm 10 \text{ } ^\circ\text{C}$ for mineral oils and $\pm 20 \text{ } ^\circ\text{C}$ for synthetic oils are permissible with respect to the conditions given in the table.

8.1.5 Oil change intervals

An overall guide to oil-change interval is given in the table, and assumes pollution-free surroundings.

When heavy overloads are present, halve the values.

Oil temperature $^\circ\text{C}$	Oil change interval [h]	
	Mineral Oil	Synthetic oil
≤ 65	8000	25000
65 ÷ 80	4000	18000
80 ÷ 95	2000	12500

Seal rings:

Duration depends on several factors such as dragging speed, temperature, ambient conditions, etc.; as a rough guide it can vary from 3150 to 25000 h.

8.1.6 Breather plugs

The gearmotors are supplied complete with a (metal) breather plug with valve mounted in the correct position according to the type of mounting position (except for type BX, see page 62).

Before commissioning it is necessary to activate the breather by tearing the closing tab on the plug.

It is necessary to keep the breather free from dirt that could compromise its functionality.

In case this is not possible, please contact Rossi S.p.A. to find a different solution.

8.2

Adapters for motors

8.2.1 Adapters for the assembly of standard IEC motors

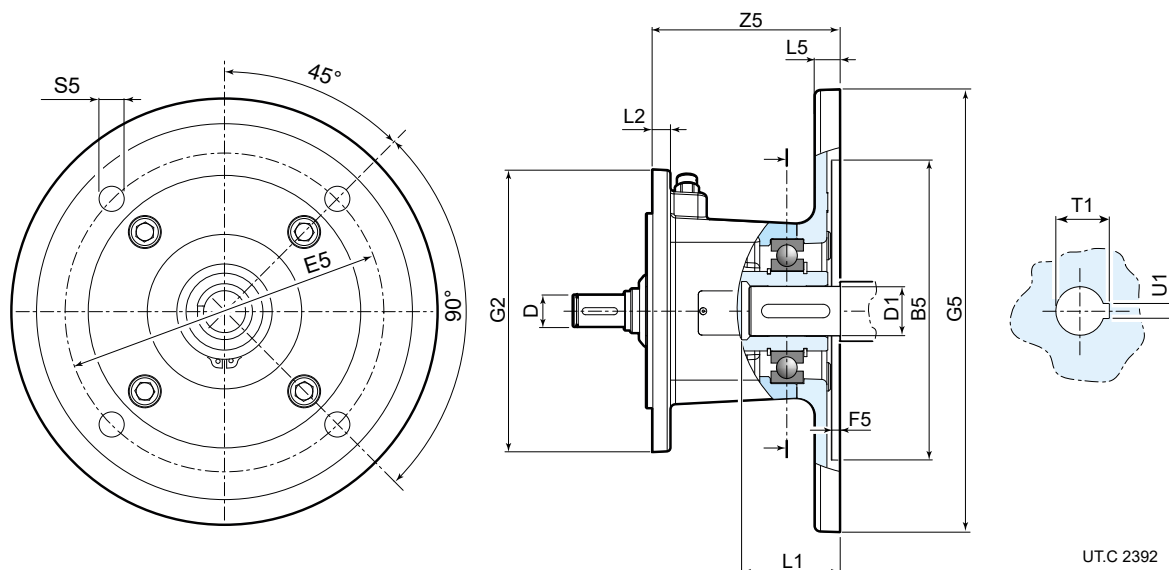

Gear reducer size	IEC motor size	Adapter code	B5 Ø H7	D Ø	D1 Ø F6	E5	F5	G2 Ø	G5 Ø	L1	L2	L5	S5 Ø	T1	U1 F9	Z5	kg
iC 27... iC 37... iO 373	63	AB12BI063	95	10	11	115	4	120	140	27	8	10	8,5	12,8	4	56,5	2,6
	71	AB12BI071	110	10	14	130	4,5	120	160	32	8	11	8,5	16,3	5	56,5	2,9
	80	AB12CI080	130	12	19	165	4,5	120	200	41,5	8	12	11	21,8	6	111	6,4
	90	AB12DI090	130	14	24	165	4,5	120	200	52	8	12	11	27,3	8	111	6,4
100, 112MA		AB12EI100	180	16	28	215	5	120	250	62	8	14	13	31,3	8	113	7,6
	63	AB16BI063	95	10	11	115	4	160	140	27	10	10	8,5	12,8	4	50,5	3
	71	AB16BI071	110	10	14	130	4,5	160	160	32	10	11	8,5	16,3	5	50,5	3,2
	80	AB16CI080	130	12	19	165	4,5	160	200	41,5	10	12	11	21,8	6	104	7,4
	90	AB16DI090	130	14	24	165	4,5	160	200	52	10	12	11	27,3	8	104	7,4
iO 473 iO 573 iO 673	100, 112MA	AB16EI100	180	16	28	215	5	160	250	62	10	14	13	31,3	8	106	8,6
	112M	AB16FI112	180	18	28	215	5	160	250	62	10	14	13	31,3	8	106	8,6
	132S, M	AB16GI13S	230	22	38	265	5	160	300	82	10	16,5	13	41,3	10	145	13,6
iC 77... iO 773	63	AB20BI063	95	10	11	115	4	200	140	27	12	10	8,5	12,8	4	44,5	3,8
	71	AB20BI071	110	10	14	130	4,5	200	160	32	12	11	8,5	16,3	5	44,5	3,9
	80	AB20CI080	130	12	19	165	4,5	200	200	41,5	12	12	11	21,8	6	98	8,1
	90	AB20DI090	130	14	24	165	4,5	200	200	52	12	12	11	27,3	8	98	8,1
	100, 112MA	AB20EI100	180	16	28	215	5	200	250	62	12	14	13	31,3	8	100	9,3
	112M	AB20FI112	180	18	28	215	5	200	250	62	12	14	13	31,3	8	100	9,3
	132S, M	AB20GI13S	230	22	38	265	5	200	300	82	12	16,5	13	41,3	10	139	15
iC 87... iO 873	132MB	AB20HI13L	230	28	38	265	5	200	300	82	12	16,5	13	41,3	10	139	15
	160	AB20HI160	250	28	42	300	6	200	350	112	12	18	18	45,3	12	186	26,6
	80	AB25CI080	130	12	19	165	4,5	250	200	41,5	14	12	11	21,8	6	94	9,2
	90	AB25DI090	130	14	24	165	4,5	250	200	52	14	12	11	27,3	8	94	9,2
	100, 112MA	AB25EI100	180	16	28	215	5	250	250	62	14	14	13	31,3	8	96	10,4
	112M	AB25FI112	180	18	28	215	5	250	250	62	14	14	13	31,3	8	96	10,4
132S, M 132MB 160 180		AB25GI13S	230	22	38	265	5	250	300	82	14	16,5	13	41,3	10	134	15,7
		AB25HI13L	230	28	38	265	5	250	300	82	14	16,5	13	41,3	10	134	15,7
		AB25HI160	250	28	42	300	6	250	350	112	14	18	18	45,3	12	181	28,7
		AB25LI180	250	32	48	300	6	250	350	112	14	18	18	51,8	14	181	28,3
	80	AB30CI080	130	12	19	165	4,5	300	200	41,5	14	12	11	21,8	6	86	11,2
iC 97... iO 973	90	AB30DI090	130	14	24	165	4,5	300	200	52	14	12	11	27,3	8	86	11,2
	100, 112MA	AB30EI100	180	16	28	215	5	300	250	62	14	14	13	31,3	8	88	12,4
	112M	AB30FI112	180	18	28	215	5	300	250	62	14	14	13	31,3	8	88	12,4
	132S, M	AB30GI13S	230	22	38	265	5	300	300	82	14	16,5	13	41,3	10	129	18
	132MB	AB30HI13L	230	28	38	265	5	300	300	82	14	16,5	13	41,3	10	129	18
	160	AB30HI160	250	28	42	300	6	300	350	112	14	18	18	45,3	12	175	30,4
	180	AB30LI180	250	32	48	300	6	300	350	112	14	18	18	51,8	14	175	30,4
200	AB30MI200	300	38	55 (E6)	350	6	300	400	113	14	18	18	59,3	16	205,5	40	

8.2.2 Adapters for the assembly of standard NEMA C-Face motors

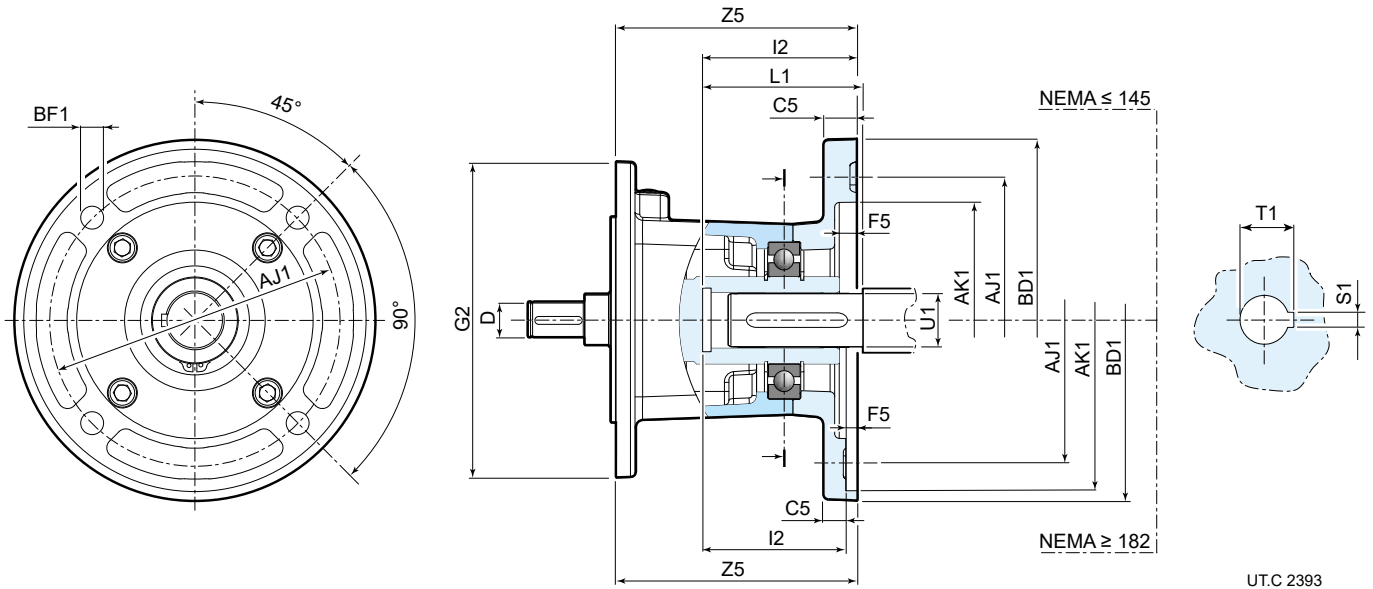

UT.C 2393

Gear reducer size	NEMA C-face motor size	Adapter code	AJ1 ∅ inch	AK1 ∅ inch	BD1 ∅ inch	BF1 ∅	C5	D ∅	F5	G2 ∅	L1	I2	S1 inch	T1	U1 ∅ inch	Z5	kg
iC 27... iC 37... iO 373	56	AB12BN056	5 7/8	4 1/2	6,5	10,5	10	10	5	120	54,7	59,5	3/16	18	5/8	81	3,3
	143	AB12CN143	5 7/8	4 1/2	6,5	10,5	12	12	5	120	64,2	61	3/16	24,5	7/8	113	5,8
	145	AB12DN145	5 7/8	4 1/2	6,5	10,5	12	14	5	120	64,2	61	3/16	24,5	7/8	113	5,8
	182	AB12EN182	5 7/8	4 1/2	9	14,5	14	16	5,5	120	79,2	76	1/4	31,5	1 1/8	124	8,1
iC 47... iC 57... iC 67... iO 473 iO 573 iO 673	56	AB16BN056	5 7/8	4 1/2	6,5	10,5	10	10	5	160	54,7	59,5	3/16	18	5/8	75	3,6
	143	AB16CN143	5 7/8	4 1/2	6,5	10,5	12	12	5	160	64,2	61	3/16	24,5	7/8	106	6,8
	145	AB16DN145	5 7/8	4 1/2	6,5	10,5	12	14	5	160	64,2	61	3/16	24,5	7/8	106	6,8
	182	AB16EN182	7 1/4	8 1/2	9	14,5	14	16	5,5	160	79,5	76	1/4	31,5	1 1/8	117	9,1
	184	AB16FN184	7 1/4	8 1/2	9	14,5	14	18	5,5	160	79,2	76	1/4	31,5	1 1/8	117	9,1
	213/215	AB16GN213	7 1/4	8 1/2	9	14,5	14	22	5,5	160	97,3	91	5/16	38,6	1 3/8	152	12,1
iC 77... iO 773	56	AB20BN056	5 7/8	4 1/2	6,5	10,5	10	10	5	200	54,7	59,5	3/16	18	5/8	69	4,3
	143	AB20CN143	5 7/8	4 1/2	6,5	10,5	12	12	5	200	64,2	61	3/16	24,5	7/8	100	7,5
	145	AB20DN145	5 7/8	4 1/2	6,5	10,5	12	14	5	200	64,2	61	3/16	24,5	7/8	100	7,5
	182	AB20EN182	7 1/4	8 1/2	9	14,5	14	16	5,5	200	79,2	76	1/4	31,5	1 1/8	111	9,8
	184	AB20FN184	7 1/4	8 1/2	9	14,5	14	18	5,5	200	79,2	76	1/4	31,5	1 1/8	111	9,8
	213/215	AB20GN213	7 1/4	8 1/2	9	14,5	14	22	5,5	200	97,3	91	5/16	38,6	1 3/8	146	13,5
iC 87... iO 873	254/256	AB20HN254	7 1/4	8 1/2	10	14,5	14	28	5,5	200	115,3	109	3/8	45,6	1 5/8	232	26,4
	143	AB25CN143	5 7/8	4 1/2	6,5	10,5	12	12	5	250	64,2	61	3/16	24,5	7/8	96	8,6
	145	AB25DN145	5 7/8	4 1/2	6,5	10,5	12	14	5	250	64,2	61	3/16	24,5	7/8	96	8,6
	182	AB25EN182	7 1/4	8 1/2	9	14,5	14	16	5,5	250	79,2	76	1/4	31,5	1 1/8	107	10,9
	184	AB25FN184	7 1/4	8 1/2	9	14,5	14	18	5,5	250	79,2	76	1/4	31,5	1 1/8	107	10,9
	213/215	AB25GN213	7 1/4	8 1/2	9	14,5	14	22	5,5	250	97,3	91	5/16	38,6	1 3/8	141	14,3
	254/256	AB25HN254	7 1/4	8 1/2	10	14,5	14	28	5,5	250	115,3	109	3/8	45,6	1 5/8	227	28,4
284/286	AB25LN284	9	10 1/2	11,25	14,5	16	32	5,5	250	134,3	128	1/2	53,4	1 7/8	229	29,5	
iC 97... iO 973	143	AB30CN143	5 7/8	4 1/2	6,5	10,5	12	12	5	300	64,2	61	3/16	24,5	7/8	88	10,6
	145	AB30DN145	5 7/8	4 1/2	6,5	10,5	12	14	5	300	64,2	61	3/16	24,5	7/8	88	10,6
	182	AB30EN182	7 1/4	8 1/2	9	14,5	14	16	5,5	300	79,2	76	1/4	31,5	1 1/8	99	12,9
	184	AB30FN184	7 1/4	8 1/2	9	14,5	14	18	5,5	300	79,2	76	1/4	31,5	1 1/8	99	12,9
	213/215	AB30GN213	7 1/4	8 1/2	9	14,5	14	22	5,5	300	97,3	91	5/16	38,6	1 3/8	136	16,4
	254/256	AB30HN254	7 1/4	8 1/2	10	14,5	14	28	5,5	300	115,3	109	3/8	45,6	1 5/8	221	30,2
	284/286	AB30LN284	9	10 1/2	11,25	14,5	16	32	5,5	300	134,3	128	1/2	53,4	1 7/8	223	31,3
	324/325	AB30MN324	11	12 1/2	14	18	20	38	5,5	300	150,3	144	1/2	59,7	2 1/8	208	41

8.3

Assembling the motor (IEC or NEMA) on adapter

Prior to fitting the customer-supplied motor, verify that the static bending torque M_b generated by the weight of the motor on the adapter counterflange is below the permitted value M_{bmax} , shown in table below:

$$M_b < M_{bmax}$$

where:

$$M_b = (G \cdot Y_G) / 1000 \text{ [N m]}$$

G [N] motor weight; numerically approximately equal to motor mass, expressed in kg, multiplied by 10.

Y_G [mm] distance of motor center of gravity from flange surface

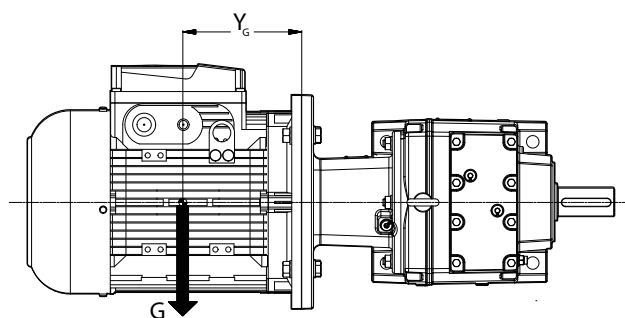

UT.C. 2440

Motors that are too long and too thin, even if the bending moment is below the prescribed table limits, can generate abnormal vibrations during operation.

In these cases, a suitable additional motor support must be provided (see specific motor documentation).

Loads above those permitted may be present in dynamic applications if the gearmotor is subject to translation, rotation or oscillation: contact Rossi to examine each individual case.

Maximum bending torque M_{bmax} related to IEC motor adapter

IEC adapter code	Maximum bending torque M_{bmax} [N m]					
	iC 27, iC 37 iO 37	iC 47 ... iO 47 ...	iC 67 iO 67	iC 77 iO 77	iC 87 iO 87	iC 97 iO 97
AB12BI063, AB12BI071, AB16BI063, AB16BI07, AB20BI063, AB20BI071	55					
AB12CI080, AB12DI090, AB16CI080, AB16DI090, AB20CI080, AB20DI090 AB25CI080, AB25DI090, AB30CI080, AB30DI090	90	265				
AB12EI0100, AB16EI0100, AB16FI0112, AB20EI0100, AB20FI0112 AB25EI0100, AB25FI0112, AB30EI0100, AB30FI0112	200	265				
AB16GI13S, AB20GI13S, AB25GI13S, AB30GI13S		290	870			
AB20HI13L, AB25HI13L, AB30HI13L			935	1155		
AB25LI180, AB30LI180				1155		
AB30MI200						1645

Maximum bending torque M_{bmax} related to NEMA motor adapter

NEMA adapter code	Maximum bending torque M_{bmax} [N m]					
	iC 27, iC 37 iO 37	iC 47 ... iO 47 ...	iC 67 iO 67	iC 77 iO 77	iC 87 iO 87	iC 97 iO 97
AB12BN056, AB16BN056, AB20BN056	45					
AB12CN143, AB12DN145, AB16CN143, AB16DN145, AB20CN143 AB20DN145, AB25CN143, AB25DN145, AB30CN143, AB30DN145	72	246				
AB12EN182, AB16EN182, AB16FN184, AB20EN182, AB20FN184, AB25EN182, AB25FN184, AB30EN182, AB30FN184	161	246				
AB16GN213, AB20GN213, AB25GN213, AB30GN213		251	656			
AB20HN254, AB25HN254, AB30HN254		740	1003			
AB25LN284, AB30LN284			1003			
AB30MN324						1430

Solid output shaft

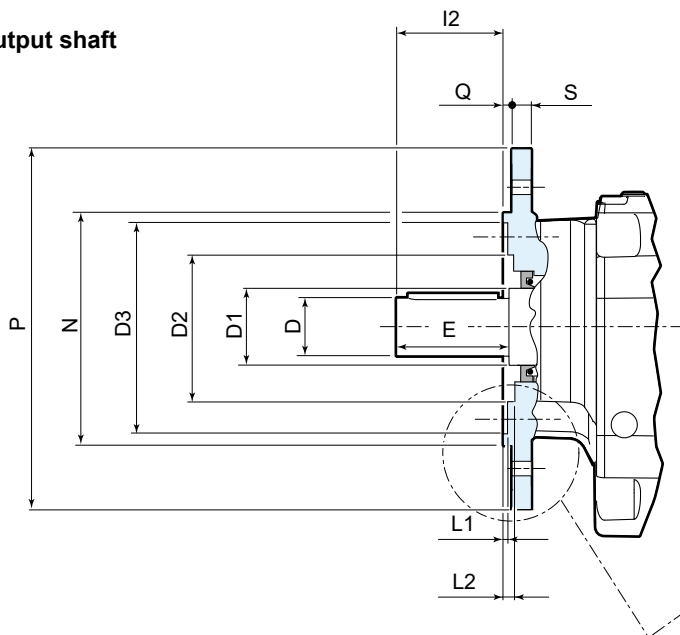

Details of gearmotor fastening flanges

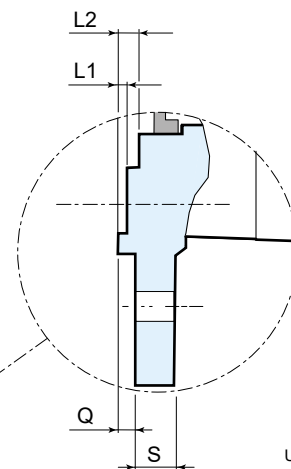

UTC 2394

Gear reducer size	B5 flange code	P Ø	N Ø j6	S	D Ø k6	D1 Ø	D2 Ø	D3 Ø	Q	I2	E	L1	L2
iC 27...	F212	120	80	8	25	30	56	66	3	50	50	2	6
	F214	140	95	9	25	30	56	80	3	50	50	2	6
	F216	160	110	10	25	30	56	94	3,5	50	50	2,6	6,5
iC 37...	F312	120	80	8	25	35	63	68	3	50	50	5	7
	F314	140	95	10	25	35	11	83	3	50	50	5	7
	F316	160	110	10	25	35	61	96	3,5	50	50	2	7,5
	F320	200	130	12	25	35	61	118	3,5	50	50	1	7,5
iC 47...	F414	140	95	10	30	35	77	82	3	60	60	4	6
	F416	160	110	10	30	35	75	96	3,5	60	60	1	6,5
	F420	200	130	12	30	35	75	116	3,5	60	60	1	6,5
iC 57...	F516	160	110	10	35	40	82	97	3,5	70	70	4	6,5
	F520	200	130	12	35	40	78	116	3,5	70	70	-0,5	6,5
	F525	250	180	15	35	40	78	160	4	70	70	0	7
iC 67...	F620	200	130	12	35	50	96	120	3,5	70	70	3,5	7
	F625	250	180	15	35	50	92	162	4	70	70	0,5	7,5
iC 77...	F725	250	180	15	40	52	94	160	4	80	80	0,5	7
	F730	300	230	18,5	40	52	113	210	4	80	80	0,5	7
iC 87...	F830	300	230	18,5	50	62	119	214	4	100	100	0	8
	F835	350	250 h6	18	50	62	138	225	5	100	100	0	8
iC 97...	F935	350	250 h6	18	60 m6	72	146	234	5	120	120	1	9
	F945	450	350 h6	22	60 m6	72	156	320	5	120	120	1	9

Gear reducer size	B5 flange code	P Ø	N Ø j6	S	D Ø k6	D1 Ø	D2 Ø	D3 Ø	Q	I2	E	L1	L2
iO 373	F316	160	110	10	25	35	61	96	3,5	50	50	2	7,5
iO 473	F420	200	130	12	30	35	75	116	3,5	60	60	1	6,5
iO 573	F525	250	180	15	35	40	78	160	4	70	70	0	7
iO 673	F625	250	180	15	40	50	92	162	4	70	70	0,5	7,5
iO 773	F730	300	180	15	50	52	94	160	4	80	80	0,5	7
iO 873	F835	350	250 h6	18	60 m6	62	138	225	5	100	100	0	8
iO 973	F945	450	350 h6	22	70 m6	72	156	320	5	120	120	1	9

Hollow output shaft

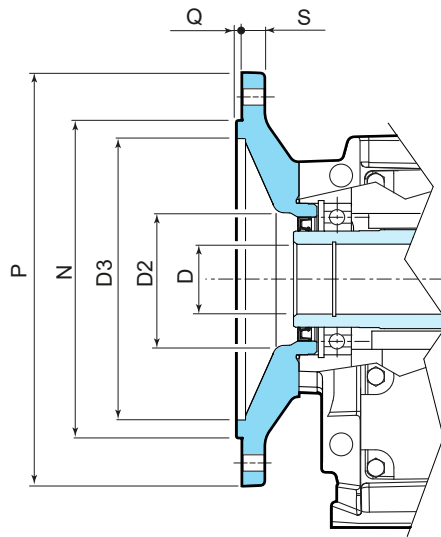

UTC 2541

Gear reducer size	B5 flange code	P Ø	N Ø j6	S	D Ø H7	D2 Ø	D3 Ø	Q
iO 373	F316	160	110	10	25	61	96	3,5
iO 473	F420	200	130	12	35	75	116	3,5
iO 573	F525	250	180	15	40	78	160	4
iO 673	F625	250	180	15	40	92	162	4
iO 773	F730	300	180	15	50	94	160	4
iO 873	F835	350	250 h6	18	60	138	225	5
iO 973	F945	450	350 h6	22	70	156	320	5

8.5

Fastening bolts

Unless otherwise stated, usually it is sufficient to use bolts in class 8.8; The following cases are an exception, for which bolts with strength class 10.9 must be used:

- iC 372 - iC 373 FE with flange F312
- iC 472 - iC 473 FE with flange F414
- iC 572 - iC 573 FE with flange F516

Thoroughly degrease the bolts before tightening. It is recommended to apply locking adhesives on the fastening bolts and on flange mating surfaces, in the event of heavy vibrations, heavy duties and/or frequent drive inversions.

Tighten the bolts to the tightening torque stated in the table.

Fastening bolts	Tightening torque M_s for bolts for foot and flange fastening N m	
	cl. 8.8	cl. 10.9
M4	2,9	4
M5	6	8,5
M6	11	15
M8	25	35
M10	50	70
M12	85	120
M14	135	190
M16	205	290
M18	280	400
M20	400	560
M22	550	770
M24	710	1000

Dimensional tolerances

Shaft height of foot mounted design iC...P...

$h \leq 250 \text{ mm} \rightarrow$ tolerance $-0,5 \div 0 \text{ mm}$

$h > 250 \text{ mm} \rightarrow$ tolerance $-1 \div 0 \text{ mm}$



Attention!

Always check that the motor does not protrude from the foot mounting surface.

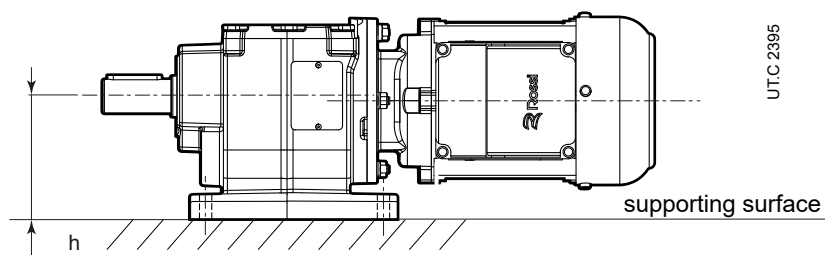

Low speed shaft end

External diameter: $\varnothing D \leq 50 \text{ mm} \rightarrow$ tolerance ISO k6
 $\varnothing D > 50 \text{ mm} \rightarrow$ tolerance ISO m6

Tapped butt-end hole: $\varnothing D \leq 24 \text{ mm} \rightarrow$ M8
 $\varnothing D > 24 \div 30 \text{ mm} \rightarrow$ M10
 $\varnothing D > 30 \div 38 \text{ mm} \rightarrow$ M12
 $\varnothing D > 38 \div 50 \text{ mm} \rightarrow$ M16
 $\varnothing D > 50 \text{ mm} \rightarrow$ M20

Key and keyway:

key to DIN 6885
 keyway width ISO N9

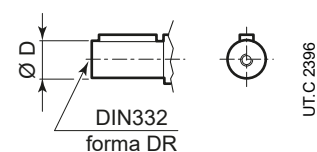

Hollow output shaft

Internal diameter: $\varnothing D \rightarrow$ tolerance ISO H7

Key and keyway:

linguetta secondo DIN 6885
 larghezza cava linguetta ISO N9

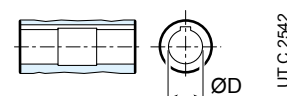

Flange

Spigot: $\varnothing N \leq 230 \text{ mm} (\varnothing P 120 \div 300 \text{ mm}) \rightarrow$ tolerance ISO j6
 $\varnothing N > 230 \text{ mm} (\varnothing P 350 \div 450 \text{ mm}) \rightarrow$ tolerance ISO h6

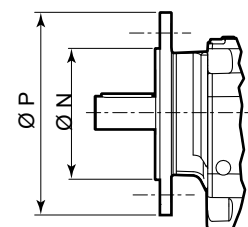

8.7

Overall dimensional remarks

8.7.1 Overall dimension details of HB and HBZ motors

The meaning of the total dimensions shown in the drawings in ch.10 and 12 is explained below:

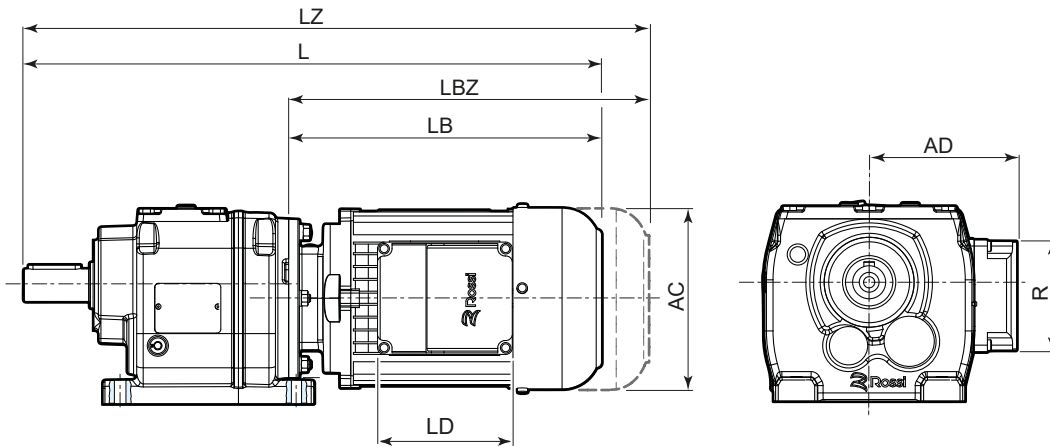

UTC 2398

where:

- L total length of gearmotor
- LZ total length of gearmotor with brake
- LB total length of motor
- LBZ total length of motor with brake
- AC diameter of motor fan cover
- LD length of motor terminal box
- AD radial dimensions of motor terminal box
- R width of motor terminal box

Motor length and terminal box dimension can slightly change according to specific motor options; if necessary, refer to cat. TX. or contact Rossi S.p.A.

Eyelets and eyebolts for lifting

Sizes \leq IC 57... are equipped with lifting eyelet for transport. Larger sizes are equipped with eyebolts. All iO bevel helical gearmotors are equipped with a "lifting hole" on the housing for handling.

Breather plugs:

Dimensional drawings indicated at ch. 10 and ch. 12 do not indicate the dimensions of breather plug as its position depends on mounting position.

Total overall dimensions can slightly differ from the stated ones.

8.7.2 Dimension details of second motor shaft end

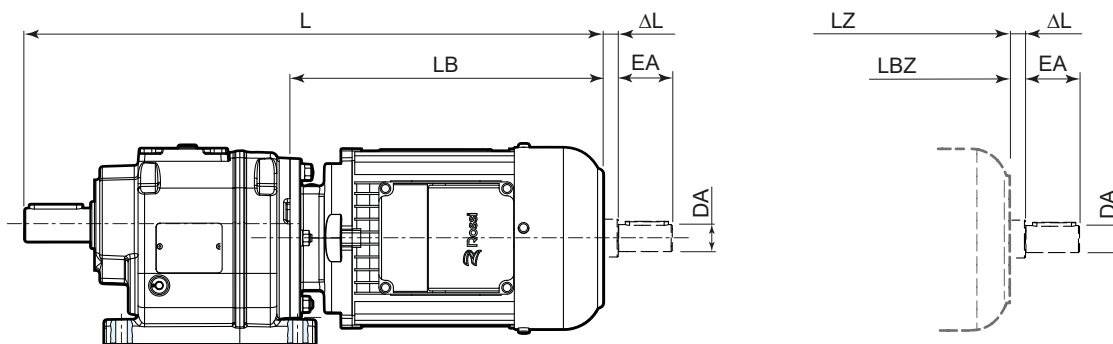

UT_C 2399

Motor size	Power	Poles	DA Ø	EA	ΔL ≈
63	A, B	2, 4, 6	11	23	5
71	A, B	2, 4, 6	11	23	5
80	A, B	2, 4, 6	14	30	7
90	S, L, LA	2, 4, 6	14	30	7
100	LA	2, 4, 6	14	30	8
112	MA	4	14	30	8
112	M	2, 4, 6	19	40	9
132	S, SB	2, 4, 6	19	40	9
132	M	4	19	40	9
132	MB	4	28	60	9

Helical inline Selection tables - iC



Section contents

9.1	Possible geometrical combinations	84
9.1.1	General	84
9.1.2	Key	84
9.2	Geometrical coupling tables	85
9.3	Selection tables [kW]	94

Geometrical coupling tables



iC

Gear reducer						Motor size									
$M_{N2max} = 145 \text{ N m}$ $n_1 = 1400 \text{ min}^{-1}$															
iC 273 - iC 272						63A 63B 71A 71B	80A 80B	90S 90L	100LA 112MA	112M	132S 132M	132MB	160M 160L	180M 180L	200L
	n_2 min ⁻¹	M_{N2} N m	F_{r2} N	φ arc min	i										
iC 273	10	145	4230	-	135,09										
	11	145	4230	-	123,91										
	13	144	4230	-	105,49										
	15	143	4230	-	90,96										
	17	143	4230	-	84,78										
	19	142	4230	-	74,11										
	20	142	4180	-	69,47										
	23	142	3980	-	61,3										
	25	141	3840	-	55,87										
	29	141	3630	-	48,17										
	31	140	3530	-	44,9										
	36	140	3350	-	39,25										
	38	139	3260	-	36,79										
	43	139	3100	-	32,47										
	49	138	2950	-	28,78										
57	138	2760	-	24,47											
iC 272	49	138	2940	-	28,37										
	54	138	2840	-	26,09										
	63	137	2660	-	22,32										
	72	137	2510	-	19,35										
	77	136	2440	-	18,08										
	90	136	2290	-	15,63										
	105	135	2140	-	13,28 ⁽¹⁾										
	118	134	1980	-	11,86										
	138	134	1890	-	10,13										
	149	130	900	-	9,41										
	172	123	870	-	8,16										
	183	120	900	-	7,63 ⁽¹⁾										
	212	110	880	-	6,59										
	250	102	880	-	5,6 ⁽¹⁾										
	280	96	860	-	5 ⁽¹⁾										
	328	87	920	-	4,27										
	350	85	900	-	4 ⁽¹⁾										
415	79	900	-	3,37											

⁽¹⁾ Finite transmission ratio i



iC

Gear reducer						Motor size									
$M_{N2max} = 224 \text{ N m}$ $n_1 = 1400 \text{ min}^{-1}$															
iC 373 - iC 372						63A 63B 71A 71B	80A 80B	90S 90L	100LA 112MA	112M	132S 132M	132MB	160M 160L	180M 180L	200L
	n_2 min ⁻¹	M_{N2} N m	F_{r2} N	φ arc min	i										
iC 373	10	217	4940	8	134,82										
	11	214	4940	8	123,66										
	13	213	4940	8	105,28										
	15	212	4940	8	90,77										
	17	212	4940	8	84,61										
	19	211	4940	8	73,96										
	20	211	4940	8	69,33										
	23	210	4940	9	61,18										
	25	209	4940	9	55,76										
	29	208	4940	9	48,08										
	31	208	4940	9	44,81										
	36	207	4760	9	39,17										
	38	206	4540	9	36,72										
	43	206	4120	9	32,4										
	49	205	3740	9	28,73										
57	204	3240	9	24,42											
iC 372	49	205	3690	8	28,32										
	54	204	3860	8	26,03										
	63	203	2970	8	22,27										
	73	202	2570	8	19,31										
	78	202	2390	8	18,05										
	90	201	2010	8	15,6										
	106	198	1880	8	13,25										
	118	189	1810	8	11,83										
	138	177	1820	9	10,11										
	148	172	1760	9	9,47										
	176	160	1720	9	7,97										
	210	145	1000	13	6,67										
	247	142	760	13	5,67										
	277	135	790	13	5,06										
	324	126	820	13	4,32										
346	122	840	14	4,05											
411	112	900	14	3,41											

Gear reducer						Motor size										
$M_{N2max} = 335 \text{ N m}$ $n_1 = 1400 \text{ min}^{-1}$																
iC 473 - iC 472						63A	80A	90S	100LA	112M	132S	132MB	160M	180M	200L	
						63B	80B	90L	112MA		132M		160L	180L		
						71A										
						71B										
	n_2	M_{N2}	F_{r2}	φ	i											
	min ⁻¹	N m	N	arc min												
iC 473	7,9	335	5420	7	176,88											
	8,6	335	5420	7	162,94											
	10	335	5420	7	139,99											
	11	335	5420	7	121,87											
	12	335	5420	7	114,17											
	14	335	5420	7	100,86											
	15	335	5420	7	93,68											
	16	335	5420	7	84,9											
	18	335	5420	7	76,23											
	 3	20	335	5420	8	68,54										
		22	335	5420	8	64,21										
		25	335	5420	8	56,73										
		27	335	5350	8	52,69										
		29	335	5140	8	47,75										
		33	335	4930	8	42,87										
		38	335	4630	8	36,93										
		40	335	4520	8	34,73										
		47	335	4240	8	29,88										
		52	335	4050	8	26,7										
	59	335	3840	8	23,59											
iC 472	41	272	4680	7	33,79											
	45	243	4610	7	31,12											
	52	335	4050	7	26,74											
	60	335	3820	7	23,28											
	64	335	3710	7	21,81											
	73	324	3530	7	19,27											
	78	315	3390	7	17,89											
	86	304	3350	7	16,22											
	96	292	3230	7	14,56											
	 2	112	275	3080	8	12,54										
		119	268	3020	8	11,79										
		138	252	2880	8	10,15										
		154	239	2780	8	9,07										
		175	228	2690	8	8,01										
		180	185	2720	10	7,76 ⁽¹⁾										
		201	180	2620	10	6,96										
		233	175	2470	10	6										
		248	175	2410	10	5,64 ⁽¹⁾										
		289	170	2280	11	4,85										
	323	165	2190	12	4,34											
366	160	2080	12	3,83												

⁽¹⁾ Finite transmission ratio i

iC



Gear reducer						Motor size									
$M_{N2max} = 500 \text{ N m}$ $n_1 = 1400 \text{ min}^{-1}$															
iC 573 - iC 572						63A 63B 71A 71B	80A 80B	90S 90L	100LA 112MA	112M	132S 132M	132MB	160M 160L	180M 180L	200L
	n_2 min ⁻¹	M_{N2} N m	F_{r2} N	φ arc min	i										
iC 573 	7,5	500	7100	7	186,89										
	8,1	500	7100	7	172,17										
	9,5	500	7100	7	147,92										
	11	496	7100	7	128,77										
	12	492	7100	7	120,63										
	13	490	7100	7	106,58										
	14	488	7100	7	98,99										
	16	487	7100	7	89,71										
	17	485	7100	7	80,55										
	20	483	7100	8	69,23										
	22	482	6980	8	64,85										
	24	480	6630	8	57,29										
	26	479	6430	8	53,22										
	29	478	6170	8	48,23										
	32	476	5900	8	43,3										
	38	474	5530	8	37,3 ⁽¹⁾										
	40	473	5390	8	35,07										
	46	471	5040	8	30,18										
52	469	4800	8	26,97											
iC 572 	53	469	4750	7	26,31										
	56	468	4640	7	24,99 ⁽¹⁾										
	64	466	4370	7	21,93										
	75	463	4050	7	18,6 ⁽¹⁾										
	83	462	3860	7	16,79										
	95	460	3690	7	14,77 ⁽¹⁾										
	100	459	3610	7	13,95 ⁽¹⁾										
	118	450	3430	7	11,88										
	130	437	3330	8	10,79										
	150	412	3180	8	9,35										
	155	387	2010	9	9,06										
	176	366	2020	9	7,97										
	186	355	1950	9	7,53										
	218	335	1770	9	6,41										
	241	320	1820	10	5,82										
277	305	1730	10	5,05											
319	280	1900	11	4,39											

⁽¹⁾ Finite transmission ratio i

Gear reducer						Motor size									
$M_{N2max} = 670 \text{ N m}$ $n_1 = 1400 \text{ min}^{-1}$															
iC 673 - iC 672						63A 63B 71A 71B	80A 80B	90S 90L	100LA 112MA	112M	132S 132M	132MB	160M 160L	180M 180L	200L
	n_2 min ⁻¹	M_{N2} N m	F_{r2} N	φ arc min	i										
iC 673	7	670	7560	7	199,81										
	7,6	670	7560	7	184,07										
	8,9	670	7560	7	158,14										
	10	670	7560	7	137,67										
	11	670	7560	7	128,97										
	12	670	7560	7	113,94										
	13	670	7560	7	105,83										
	15	670	7560	7	95,91										
	16	670	7560	7	86,11										
	19	670	7560	7	74,17										
	20	670	7560	7	69,75										
	23	670	7560	7	61,26										
	25	670	7560	7	56,89										
	27	668	7560	8	51,56										
	30	643	7560	8	46,29										
	35	611	7790	8	39,88 ⁽¹⁾										
	37	598	7900	8	37,5										
	43	567	8210	8	32,27										
	49	545	8400	8	28,83										
iC 672	50	600	8210	6	28,13										
	52	600	8210	6	26,72										
	60	630	8010	7	23,44										
	70	655	7560	7	19,89										
	78	633	7330	7	17,95										
	89	606	7130	7	15,79										
	94	590	6980	7	14,91										
	110	541	6640	7	12,7										
	121	515	6500	7	11,54										
	140	477	6220	7	10										
	161	442	5960	7	8,7 ⁽¹⁾										
	180	380	5830	9	7,79										
	190	370	5790	9	7,36 ⁽¹⁾										
	223	330	5590	9	6,27										
	246	310	5450	10	5,7										
	284	290	5210	10	4,93										
326	270	5000	10	4,29											

⁽¹⁾ Finite transmission ratio i

iC



Gear reducer						Motor size									
$M_{N2max} = 925 \text{ N m}$ $n_1 = 1400 \text{ min}^{-1}$															
iC 773 - iC 772						63A 63B 71A 71B	80A 80B	90S 90L	100LA 112MA	112M	132S 132M	132MB	160M 160L	180M 180L	200L
	n_2 min ⁻¹	M_{N2} N m	F_{r2} N	φ arc min	i										
iC 773 	7.2	925	9920	7	195,24 ⁽¹⁾										
	8.4	925	9920	7	166,59										
	9.6	925	9920	7	145,67										
	10	925	9920	7	138,39										
	12	916	9920	7	121,42										
	14	911	9920	7	102,99										
	15	908	9920	7	92,97										
	17	905	9920	7	81,8										
	18	903	9920	7	77,24										
	21	899	9920	7	65,77										
	24	895	9920	8	57,68										
	27	892	9920	8	52,07										
	31	888	9920	8	45,81										
	32	887	9920	8	43,26										
	38	876	9920	8	36,83										
	42	849	9920	8	33,47										
	48	820	9920	8	29										
55	780	10100	8	25,23											
iC 772 	60	820	8870	7	23,37										
	65	820	8250	7	21,43										
	74	780	7980	7	18,8										
	79	780	7620	7	17,82 ⁽¹⁾										
	90	740	7390	7	15,6										
	100	720	7050	7	14,05										
	114	690	6740	7	12,33										
	129	660	6490	7	10,88										
	145	630	6300	7	9,64										
	163	630	4110	8	8,59										
	181	610	3940	8	7,74										
	206	580	3850	8	6,79										
	234	540	3990	8	5,99 ⁽¹⁾										
264	510	3990	9	5,31 ⁽¹⁾											

⁽¹⁾ Finite transmission ratio i

Gear reducer						Motor size									
$M_{N2max} = 1750 \text{ N m}$ $n_1 = 1400 \text{ min}^{-1}$															
iC 873 - iC 872						63A 63B 71A 71B	80A 80B	90S 90L	100LA 112MA	112M	132S 132M	132MB	160M 160L	180M 180L	200L
	n_2 min ⁻¹	M_{N2} N m	F_{r2} N	φ arc min	i										
iC 873	5,7	1750	16900	6	246,54										
	6,5	1750	16900	6	216,54										
	6,8	1750	16900	6	205,71										
	7,7	1750	16900	6	181,77										
	9	1750	16900	6	155,34										
	9,8	1750	16900	6	142,41										
	11	1750	16900	6	124,97										
	12	1750	16900	6	118,43 ⁽¹⁾										
	14	1750	16900	6	103,65										
	15	1747	16900	6	93,38										
	17	1740	16900	6	81,92										
	19	1733	16900	7	72,57										
	22	1726	15800	7	63,68 ⁽¹⁾										
	23	1723	15200	7	60,35 ⁽¹⁾										
	27	1716	13500	7	52,82										
	29	1710	12300	7	47,58										
	34	1703	10800	7	41,74										
	38	1696	9470	7	36,84 ⁽¹⁾										
43	1690	8220	7	32,66 ⁽¹⁾											
50	1646	7370	7	27,88											
iC 872	41	1693	9480	6	34,4 ⁽¹⁾										
	45	1688	7820	6	31,4										
	50	1675	6640	6	27,84 ⁽¹⁾										
	60	1579	5000	6	23,4										
	65	1535	4970	6	21,51										
	73	1475	4800	6	19,1										
	82	1420	4580	6	17,08 ⁽¹⁾										
	91	1369	4450	6	15,35										
	105	1305	4220	6	13,33										
	117	1257	4120	6	11,93										
	141	1180	3520	7	9,9 ⁽¹⁾										
	153	1210	99	7	9,14 ⁽¹⁾										
	170	1160	225	7	8,22										
	196	1070	820	7	7,13										
	219	1020	970	7	6,39										
264	910	1710	7	5,3 ⁽¹⁾											

⁽¹⁾ Finite transmission ratio i

iC









Gear reducer						Motor size										
$M_{N2max} = 3350 \text{ N m}$ $n_1 = 1400 \text{ min}^{-1}$																
iC 973 - iC 972						63A 63B 71A 71B	80A 80B	90S 90L	100LA 112MA	112M	132S 132M	132MB	160M 160L	180M 180L	200L	
	n_2 min ⁻¹	M_{N2} N m	F_{r2} N	φ arc min	i											
iC 973 	4,8	3350	19800	6	289,74											
	5,5	3350	19800	6	255,71											
	5,8	3350	19800	6	241,25											
	6,5	3350	19800	6	216,28											
	7,5	3350	19800	6	186,3											
	8,2	3350	19800	6	170,02											
	9,3	3350	19800	6	150,78											
	11	3316	19800	6	126,75											
	12	3274	19800	6	116,48											
	14	3261	19800	6	103,44											
	15	3249	19800	6	92,48											
	17	3239	19800	6	83,15											
	19	3224	18000	6	72,17											
	21	3214	16300	7	65,21											
	23	3205	14800	7	59,92											
	26	3193	12900	7	53,21											
	29	3182	11100	7	47,58											
	33	3171	9480	7	42,78											
38	3088	7410	7	37,13												
42	2972	7160	7	33,25												
51	2783	7260	7	27,58												
iC 972 	44	2900	10600	6	32,05											
	51	2900	8380	6	27,19											
	56	2927	4140	6	25,03											
	63	2822	4060	6	22,37											
	70	2728	4110	6	20,14											
	77	2642	4270	6	18,24											
	87	2541	4130	6	16,17											
	96	2461	4240	6	14,62											
	113	2335	3850	6	12,39											
	129	2237	3720	6	10,83											
	151	2184	-	6	9,29											
	167	2081	-	6	8,39											
	197	2000	-	6	7,12											
	225	1890	-	6	6,21											
	269	1780	-	7	5,2											
311	1630	-	7	4,5 ⁽¹⁾												

⁽¹⁾ Finite transmission ratio i







page intentionally left blank

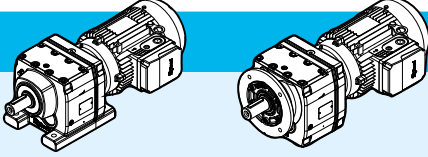

9.3

Selection tables [kW]

$P_1 = 0,12 \text{ kW}$												
n_2 min ⁻¹	M_2 N m	i	F_{r2} N	f_s		foot		flange				
						HB	HBZ	HB	HBZ			
4,7	246	195,24 ⁽¹⁾	12900	3,8	iC 773 – HB2 63 B 6 B20B		45	47	52	54	144	
5,5	210	166,59	13000	4,4								
6,2	183	145,67	13000	5								
4,6	252	199,81	10000	2,7	iC 673 – HB2 63 B 6 B16B		36	38	39	41	142	
4,9	232	184,07	10100	2,9								
5,8	199	158,14	10200	3,4								
6,6	173	137,67	10300	3,9								
7,1	162	128,97	10300	4,1								
8,0	143	113,94	10400	4,7								
6,9	167	199,81	10300	4	iC 673 – HB2 63 A 4 B16B		36	38	39	41	142	
7,4	154	184,07	10400	4,4								
4,9	235	186,89	7760	2,1	iC 573 – HB2 63 B 6 B16B		28	29	31	33	140	
5,3	217	172,17	7800	2,3								
6,2	186	147,92	7860	2,7								
7,1	162	128,77	7900	3,1								
7,5	152	120,63	7920	3,3								
8,5	134	106,58	7940	3,7								
9,2	125	98,99	7950	4								
7,3	156	186,89	7920	3,2	iC 573 – HB2 63 A 4 B16B		27	29	30	32	140	
8,0	144	172,17	7940	3,5								
9,3	124	147,92	7960	4								
11	108	128,77	7980	4,6								
5,1	223	176,88	5730	1,5	iC 473 – HB2 63 B 6 B16B		21	23	22	24	138	
5,6	205	162,94	5800	1,65								
6,5	176	139,99	5900	1,9								
7,5	153	121,87	5970	2,2								
7,7	148	176,88	6000	2,3	iC 473 – HB2 63 A 4 B16B		21	23	22	24	138	
8,4	136	162,94	6030	2,5								
9,8	117	139,99	6070	2,9								
11	102	121,87	6100	3,3								
12	96	114,17	6100	3,5								
14	84	100,86	6120	4								
15	78	93,68	6130	4,3								
6,7	170	134,82	4870	1,3			iC 373 – HB2 63 B 6 B12B		15	17	17	19
7,4	156	123,66	5290	1,45								
8,6	133	105,28	5560	1,7								
10	114	90,77	5700	1,9								
11	107	84,61	5750	2								
12	93	73,96	5830	2,3								

⁽¹⁾ Finite transmission ratio i

$P_1 = 0,12 \text{ kW}$											
n_2 min ⁻¹	M_2 N m	i	F_{r2} N	fs		foot		flange			
						HB	HBZ	HB	HBZ		
10	113	134,82	5750	1,95	iC 373 – HB2 63 A 4 B12B		14	16	16	18	136
11	103	123,66	5800	2,1							
13	88	105,28	5880	2,4							
15	76	90,77	5930	2,8							
16	71	84,61	5950	3							
19	62	73,96	5980	3,4							
7,3	156	123,91	2660	0,95	iC 273 – HB2 63 B 6 B12B		14	16	16	18	134
8,6	133	105,49	3300	1,1							
10	115	90,96	3800	1,25							
11	107	84,78	3990	1,35							
12	93	74,11	4060	1,55							
10	113	135,09	3990	1,3	iC 273 – HB2 63 A 4 B12B		13	15	13	15	134
11	104	123,91	4040	1,4							
13	88	105,49	4110	1,65							
15	76	90,96	4170	1,9							
16	71	84,78	4200	2							
18	62	74,11	4240	2,3							
20	58	69,47	4260	2,4							
22	51	61,3	4290	2,8							
25	47	55,87	4280	3							
28	40	48,17	4090	3,5							
31	38	44,9	4000	3,7							

$P_1 = 0,18 \text{ kW}$											
4,7	369	195,24 ⁽¹⁾	12600	2,5	iC 773 – HB2 71 A 6 B20B		45	47	51	54	144
5,5	315	166,59	12800	2,9							
6,2	275	145,67	12900	3,4							
6,6	261	138,39	12900	3,5							
7,5	229	121,42	13000	4							
7,0	247	195,24 ⁽¹⁾	12900	3,7	iC 773 – HB2 63 B 4 B20B		45	47	51	54	144
8,2	211	166,59	13000	4,4							
9,3	184	145,67	13000	5							
9,8	175	138,39	13000	5,3							
4,6	377	199,81	9490	1,8	iC 673 – HB2 71 A 6 B16B		38	40	40	43	142
4,9	348	184,07	9660	1,95							
5,8	299	158,14	9900	2,2							
6,6	260	137,67	10100	2,6							
7,1	244	128,97	10100	2,8							
8,0	215	113,94	10200	3,1							
8,6	200	105,83	10300	3,4							
9,5	181	95,91	10300	3,7							
11	163	86,11	10400	4,1							
12	140	74,17	10400	4,8							
13	132	69,75	10400	5,1							

⁽¹⁾ Finite transmission ratio i



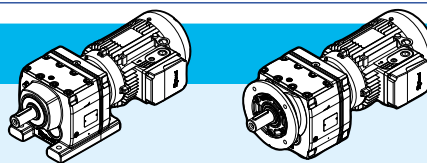

$P_1 = 0,18 \text{ kW}$





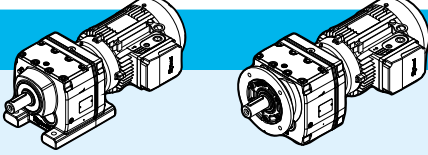

kg

p.

n_2 min ⁻¹	M_2 N m	i	F_{r2} N	fs		foot		flange			
						HB	HBZ	HB	HBZ		
6,8	253	199,81	10100	2,7	iC 673 – HB2 63 B 4 B16B		36	38	39	40	142
7,4	233	184,07	10200	2,9							
8,6	200	158,14	10300	3,4							
9,9	174	137,67	10300	3,9							
11	163	128,97	10400	4,1							
12	144	113,94	10400	4,7							
13	134	105,83	10400	5							
4,9	353	186,89	7480	1,4	iC 573 – HB2 71 A 6 B16B		29	32	32	35	140
5,3	325	172,17	7560	1,55							
6,2	279	147,92	7690	1,8							
7,1	243	128,77	7770	2,1							
7,5	228	120,63	7800	2,2							
7,3	236	186,89	7790	2,1	iC 573 – HB2 63 B 4 B16B		28	29	31	33	140
7,9	218	172,17	7820	2,3							
9,2	187	147,92	7880	2,7							
11	163	128,77	7910	3							
11	152	120,63	7930	3,2							
13	135	106,58	7950	3,6							
14	125	98,99	7960	3,9							
15	113	89,71	7970	4,3							
7,7	224	176,88	5780	1,5			iC 473 – HB2 63 B 4 B16B		21	23	22
8,3	206	162,94	5840	1,65							
9,7	177	139,99	5930	1,9							
11	154	121,87	5990	2,2							
12	144	114,17	6010	2,3							
13	127	100,86	6050	2,6							
15	118	93,68	6070	2,8							
16	107	84,9	6090	3,1							
18	96	76,23	6100	3,5							
7,4	234	123,66	3330	0,95	iC 373 – HB2 71 A 6 B12B		16	19	18	21	136
8,6	199	105,28	4300	1,15							
10	171	90,77	5070	1,3							
11	160	84,61	5390	1,35							
10	170	134,82	5130	1,3	iC 373 – HB2 63 B 4 B12B		15	17	17	19	136
11	156	123,66	5430	1,35							
13	133	105,28	5620	1,6							
15	115	90,77	5740	1,85							
16	107	84,61	5780	2							
18	93	73,96	5860	2,3							
20	88	69,33	5880	2,4							
22	77	61,18	5930	2,7							
24	70	55,76	5950	3							
28	61	48,08	5890	3,4							

$P_1 = 0,18 \text{ kW}$											
n_2 min ⁻¹	M_2 N m	i	F_{r2} N	fs		foot		flange			
						HB	HBZ	HB	HBZ		
11	157	123,91	2880	0,9	iC 273 – HB2 63 B 4 B12B		14	15	14	16	134
13	133	105,49	3490	1,1							
15	115	90,96	3960	1,25							
16	107	84,78	4020	1,35							
18	94	74,11	4090	1,5							
20	88	69,47	4110	1,6							
22	77	61,3	4160	1,85							
24	71	55,87	4170	2							
28	61	48,17	4000	2,3							
30	57	44,9	3920	2,5							
35	50	39,25	3770	2,8							
37	47	36,79	3700	3							
42	41	32,47	3560	3,4							
47	36	28,78	3440	3,8							
56	31	24,47	3270	4,4							
48	36	28,37	3420	3,9	iC 272 – HB2 63 B 4 B12B		14	15	14	16	134
52	33	26,09	3340	4,2							
61	28	22,32	3180	4,9							
70	24	19,35	3050	5,6							
75	23	18,08	2980	6							
87	20	15,63	2850	6,9							
102	17	13,28 ⁽¹⁾	2710	8							

$P_1 = 0,25 \text{ kW}$											
4,6	518	195,24 ⁽¹⁾	12000	1,8	iC 773 – HB2 71 B 6 B20B		46	48	52	55	144
5,4	442	166,59	12400	2,1							
6,2	386	145,67	12600	2,4							
7,2	333	195,24 ⁽¹⁾	12700	2,8	iC 773 – HB2 71 A 4 B20B		44	47	51	54	144
8,4	284	166,59	12800	3,3							
9,6	248	145,67	12900	3,7							
10	236	138,39	13000	3,9							
12	207	121,42	13000	4,4							
4,5	530	199,81	8390	1,25	iC 673 – HB2 71 B 6 B16B		38	41	41	44	142
4,9	488	184,07	8750	1,35							
5,7	420	158,14	9250	1,6							
6,5	365	137,67	9580	1,85							
7,0	342	128,97	9700	1,95							
7,9	302	113,94	9900	2,2							
8,5	281	105,83	9990	2,4							
7,0	341	199,81	9690	1,95	iC 673 – HB2 71 A 4 B16B		37	40	40	43	142
7,6	314	184,07	9820	2,1							
8,9	270	158,14	10000	2,5							

⁽¹⁾ Finite transmission ratio i



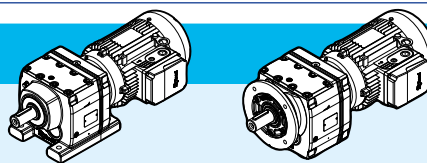



$P_1 = 0,25 \text{ kW}$

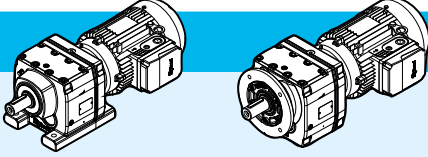

kg

p.

n_2 min ⁻¹	M_2 N m	i	F_{r2} N	fs		foot		flange			
						HB	HBZ	HB	HBZ		
10	235	137,67	10100	2,9	iC 673 – HB2 71 A 4 B16B		37	40	40	43	142
11	220	128,97	10200	3							
12	194	113,94	10300	3,4							
13	180	105,83	10300	3,7							
15	164	95,91	10400	4,1							
16	147	86,11	10400	4,6							
4,8	496	186,89	6390	1	iC 573 – HB2 71 B 6 B16B		30	32	33	36	140
5,2	457	172,17	7110	1,1							
6,1	392	147,92	7360	1,25							
7,0	342	128,77	7520	1,45							
7,5	320	120,63	7590	1,55							
8,4	283	106,58	7690	1,75							
9,1	263	98,99	7730	1,9							
7,5	319	186,89	7580	1,55	iC 573 – HB2 71 A 4 B16B		29	31	32	35	140
8,1	294	172,17	7650	1,7							
9,5	252	147,92	7750	2							
11	220	128,77	7820	2,3							
12	206	120,63	7840	2,4							
13	182	106,58	7880	2,7							
14	169	98,99	7900	2,9							
16	153	89,71	7920	3,2							
17	137	80,55	7940	3,5							
20	118	69,23	7960	4,1							
7,9	302	176,88	4980	1,1	iC 473 – HB2 71 A 4 B16B		22	25	23	26	138
8,6	278	162,94	5540	1,2							
10	239	139,99	5710	1,4							
11	208	121,87	5830	1,6							
12	195	114,17	5870	1,7							
14	172	100,86	5940	1,95							
15	160	93,68	5970	2,1							
16	145	84,9	6010	2,3							
18	130	76,23	6040	2,6							
20	117	68,54	6070	2,9							
22	110	64,21	6080	3,1							
25	97	56,73	6100	3,5							
27	90	52,69	6110	3,7							
29	81	47,75	5940	4,1							
10	230	134,82	3420	0,95	iC 373 – HB2 71 A 4 B12B		16	19	18	21	136
11	211	123,66	3950	1							
13	180	105,28	4840	1,2							
15	155	90,77	5430	1,35							
17	144	84,61	5520	1,45							
19	126	73,96	5660	1,65							
20	118	69,33	5710	1,8							

$P_1 = 0,25 \text{ kW}$											
n_2 min ⁻¹	M_2 N m	i	F_{r2} N	fs		foot		flange			
						HB	HBZ	HB	HBZ		
23	104	61,18	5800	2	iC 373 – HB2 71 A 4 B12B		16	19	18	21	136
25	95	55,76	5840	2,2							
29	82	48,08	5740	2,5							
31	76	44,81	5630	2,7							
36	67	39,17	5410	3,1							
38	63	36,72	5310	3,3							
43	55	32,4	5110	3,7							
17	145	84,78	3160	1	iC 273 – HB2 71 A 4 B12B		15	17	15	18	134
19	126	74,11	3640	1,15							
20	118	69,47	3850	1,2							
23	105	61,3	4030	1,35							
25	95	55,87	4010	1,5							
29	82	48,17	3860	1,7							
31	77	44,9	3790	1,85							
36	67	39,25	3650	2,1							
38	63	36,79	3590	2,2							
43	55	32,47	3460	2,5							
49	49	28,78	3350	2,8							
57	42	24,47	3200	3,3							
49	48	28,37	3340	2,9	iC 272 – HB2 71 A 4 B12B		15	17	15	18	134
54	44	26,09	3260	3,1							
63	38	22,32	3110	3,6							
72	33	19,35	2980	4,1							
77	31	18,08	2920	4,4							
90	27	15,63	2800	5,1							
105	23	13,28 ⁽¹⁾	2660	6							
118	20	11,86	2570	6,6							
138	17	10,13	2450	7,7							
149	16	9,41	2380	7,6							
172	14	8,16	2280	8,9							
184	13	7,63 ⁽¹⁾	2230	9,2							
212	11	6,59	2130	9,8							
250	10	5,6 ⁽¹⁾	2020	11							
280	9	5 ⁽¹⁾	1950	11							
328	7	4,27	1860	12							
350	6,8	4 ⁽¹⁾	1820	13							
415	6	3,37	1720	14							

iC

⁽¹⁾ Finite transmission ratio i

$P_1 = 0,37 \text{ kW}$

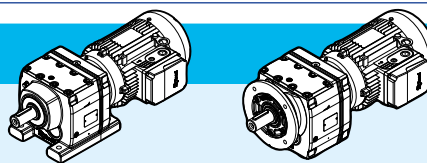





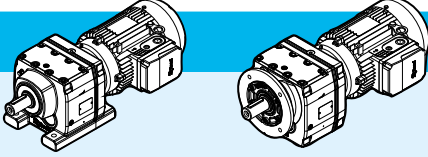

kg

p.

n_2 min ⁻¹	M_2 N m	i	F_{r2} N	fs		foot		flange			
						HB	HBZ	HB	HBZ		
3,2	1101	289,74	28100	3	iC 973 – HB2 80 A 6 B30C		134	138	150	154	148
3,6	972	255,71	28300	3,4							
3,9	917	241,25	28300	3,7							
4,3	822	216,28	28400	4,1							
3,8	937	246,54	20000	1,85	iC 873 – HB2 80 A 6 B25C		81	85	89	93	146
4,3	823	216,54	20000	2,1							
4,5	782	205,71	20000	2,2							
5,1	691	181,77	20000	2,5							
6,0	590	155,34	20000	3							
6,5	541	142,41	20000	3,2							
5,6	633	166,59	11400	1,45	iC 773 – HB2 80 A 6 B20C		47	51	53	57	144
6,4	553	145,67	11800	1,65							
6,7	526	138,39	12000	1,75							
7,2	493	195,24 ⁽¹⁾	12100	1,9	iC 773 – HB2 71 B 4 B20B		45	48	52	55	144
8,4	420	166,59	12400	2,2							
9,6	368	145,67	12600	2,5							
10	349	138,39	12700	2,6							
12	306	121,42	12800	3							
14	260	102,99	12900	3,5							
15	235	92,97	13000	3,9							
5,9	601	158,14	7590	1,1			iC 673 – HB2 80 A 6 B16C		40	44	42
6,8	523	137,67	8400	1,3							
7,2	490	128,97	8690	1,35							
8,2	433	113,94	9130	1,55							
7,0	504	199,81	8590	1,35	iC 673 – HB2 71 B 4 B16B		38	41	41	44	142
7,6	465	184,07	8910	1,45							
8,9	399	158,14	9370	1,7							
10	347	137,67	9670	1,95							
11	326	128,97	9780	2,1							
12	288	113,94	9950	2,3							
13	267	105,83	10000	2,5							
15	242	95,91	10100	2,8							
16	217	86,11	10200	3,1							
19	187	74,17	10300	3,6							
20	176	69,75	10300	3,8							
23	155	61,26	10400	4,3							
25	144	56,89	10400	4,7							
7,2	489	128,77	6410	1	iC 573 – HB2 80 A 6 B16C		31	35	34	38	140
7,7	458	120,63	7000	1,1							
8,7	405	106,58	7300	1,25							
9,4	376	98,99	7400	1,35							
7,5	472	186,89	6790	1,05	iC 573 – HB2 71 B 4 B16B		30	32	33	35	140
8,1	435	172,17	7190	1,15							
9,5	373	147,92	7420	1,35							

⁽¹⁾ Finite transmission ratio i

$P_1 = 0,37 \text{ kW}$										
n_2 min ⁻¹	M_2 N m	i	F_{r2} N	fs		foot		flange		
						HB	HBZ	HB	HBZ	
11	325	128,77	7570	1,55	iC 573 – HB2 71 B 4 B16B 	30	32	33	35	140
12	304	120,63	7630	1,6						
13	269	106,58	7720	1,8						
14	250	98,99	7760	1,95						
16	226	89,71	7810	2,2						
17	203	80,55	7850	2,4						
20	175	69,23	7900	2,8						
22	164	64,85	7910	2,9						
24	145	57,29	7700	3,3						
26	134	53,22	7540	3,6						
29	122	48,23	7320	3,9						
10	353	139,99	3770	0,95		iC 473 – HB2 71 B 4 B16B 	23	26	24	27
11	308	121,87	4880	1,1						
12	288	114,17	5360	1,15						
14	255	100,86	5650	1,3						
15	236	93,68	5730	1,4						
16	214	84,9	5810	1,55						
18	192	76,23	5880	1,75						
20	173	68,54	5940	1,95						
22	162	64,21	5970	2,1						
25	143	56,73	6020	2,3						
27	133	52,69	5940	2,5						
29	121	47,75	5780	2,8						
33	108	42,87	5610	3,1						
38	93	36,93	5370	3,6						
40	88	34,73	5280	3,8						
41	85	33,79	5230	3,2	iC 472 – HB2 71 B 4 B16B 	23	26	24	27	138
45	79	31,12	5110	3,1						
52	67	26,74	4880	5						
60	59	23,28	4680	5,7						
64	55	21,81	4590	6,1						
15	229	90,77	3480	0,95	iC 373 – HB2 71 B 4 B12B 	17	19	19	21	136
17	214	84,61	3920	1						
19	187	73,96	4670	1,15						
20	175	69,33	5000	1,2						
23	154	61,18	5450	1,35						
25	141	55,76	5560	1,5						
29	121	48,08	5550	1,7						
31	113	44,81	5440	1,85						
36	99	39,17	5250	2,1						
38	93	36,72	5160	2,2						
43	82	32,4	4980	2,5						
49	73	28,73	4810	2,8						
57	62	24,42	4590	3,3						

$P_1 = 0,37 \text{ kW}$

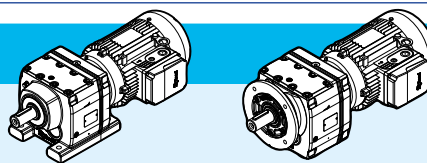

kg







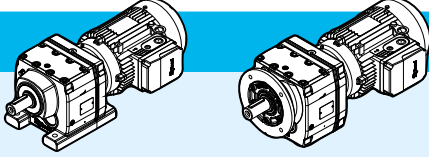

p.

n_2 min ⁻¹	M_2 N m	i	F_{r2} N	fs		foot		flange			
						HB	HBZ	HB	HBZ		
49	71	28,32	4790	2,9	iC 372 – HB2 71 B 4 B12B		17	19	19	21	136
54	66	26,03	4680	3,1							
63	56	22,27	4470	3,6							
73	49	19,31	4280	4,2							
78	46	18,05	4200	4,4							
90	39	15,6	4020	5,1							
106	33	13,25	3820	5,9							
118	30	11,83	3690	6,3							
23	155	61,3	2930	0,9	iC 273 – HB2 71 B 4 B12B		16	18	16	19	134
25	141	55,87	3280	1							
29	122	48,17	3660	1,15							
31	113	44,9	3600	1,25							
36	99	39,25	3490	1,4							
38	93	36,79	3430	1,5							
43	82	32,47	3330	1,7							
49	73	28,78	3230	1,9							
57	62	24,47	3090	2,2							
49	72	28,37	3220	1,95	iC 272 – HB2 71 B 4 B12B		16	18	16	19	134
54	66	26,09	3140	2,1							
63	56	22,32	3020	2,4							
72	49	19,35	2900	2,8							
77	46	18,08	2840	3							
90	39	15,63	2730	3,4							
105	34	13,28 ⁽¹⁾	2600	4							

$P_1 = 0,55 \text{ kW}$

3,2	1654	289,74	27500	2	iC 973 – HB2 80 B 6 B30C		136	140	152	156	148
3,6	1460	255,71	27800	2,3							
3,8	1377	241,25	27900	2,4							
4,3	1235	216,28	28000	2,7							
4,8	1083	289,74	28200	3,1	iC 973 – HB2 80 A 4 B30C		134	138	150	154	148
5,5	956	255,71	28300	3,5							
5,8	902	241,25	28300	3,7							
6,5	809	216,28	28400	4,1							
3,7	1408	246,54	15600	1,25	iC 873 – HB2 80 B 6 B25C		83	87	91	95	146
4,2	1236	216,54	17900	1,4							
4,5	1174	205,71	18800	1,5							
5,1	1038	181,77	19900	1,7							
5,9	887	155,34	20000	1,95							
5,7	922	246,54	20000	1,9	iC 873 – HB2 80 A 4 B25C		81	85	89	93	146
6,5	810	216,54	20000	2,2							
6,8	769	205,71	20000	2,3							
7,7	680	181,77	20000	2,6							





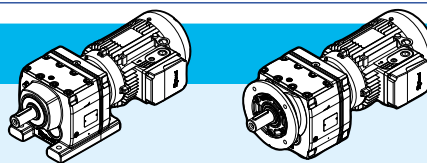

⁽¹⁾ Finite transmission ratio i

$P_1 = 0,55 \text{ kW}$											
n_2 min ⁻¹	M_2 N m	i	F_{r2} N	fs		foot		flange			
						HB	HBZ	HB	HBZ		
9,0	581	155,34	20000	3	iC 873 – HB2 80 A 4 B25C		81	85	89	93	146
9,9	532	142,41	20000	3,3							
11	467	124,97	20000	3,7							
12	443	118,43 ⁽¹⁾	20000	4							
14	387	103,65	20000	4,5							
8,4	623	166,59	11500	1,5	iC 773 – HB2 80 A 4 B20C		46	50	53	57	144
9,6	545	145,67	11900	1,7							
10	517	138,39	12000	1,8							
12	454	121,42	12300	2							
14	385	102,99	12600	2,4							
15	348	92,97	12700	2,6							
17	306	81,8	12800	3							
18	289	77,24	12800	3,1							
21	246	65,77	12900	3,7							
8,9	591	158,14	7800	1,15	iC 673 – HB2 80 A 4 B16C		39	43	42	46	142
10	515	137,67	8550	1,3							
11	482	128,97	8820	1,4							
12	426	113,94	9220	1,55							
13	396	105,83	9420	1,7							
15	359	95,91	9630	1,85							
16	322	86,11	9810	2,1							
19	277	74,17	10000	2,4							
20	261	69,75	10100	2,6							
23	229	61,26	10200	2,9							
25	213	56,89	10200	3,2							
12	451	120,63	7140	1,1	iC 573 – HB2 80 A 4 B16C		31	34	34	38	140
13	398	106,58	7340	1,25							
14	370	98,99	7440	1,3							
16	335	89,71	7550	1,45							
17	301	80,55	7640	1,6							
20	259	69,23	7740	1,85							
22	242	64,85	7670	2							
25	214	57,29	7420	2,2							
26	199	53,22	7280	2,4							
29	180	48,23	7090	2,6							
32	162	43,3	6880	2,9							
38	139	37,3 ⁽¹⁾	6600	3,4							
40	131	35,07	6480	3,6							
53	98	26,31	5960	4,8	iC 572 – HB2 80 A 4 B16C		30	33	33	37	140
56	93	24,99 ⁽¹⁾	5870	5							
64	82	21,93	5650	5,7							
76	70	18,6 ⁽¹⁾	5380	6,7							
15	350	93,68	3940	0,95	iC 473 – HB2 80 A 4 B16C		24	28	25	29	138
17	317	84,9	4730	1,05							





⁽¹⁾ Finite transmission ratio i



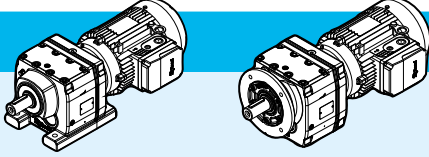

$P_1 = 0,55 \text{ kW}$



n_2 min ⁻¹	M_2 N m	i	F_{r2} N	fs		foot		flange		p.	
						HB	HBZ	HB	HBZ		
18	285	76,23	5510	1,2	iC 473 – HB2 80 A 4 B16C		24	28	25	29	138
20	256	68,54	5660	1,3							
22	240	64,21	5720	1,4							
25	212	56,73	5800	1,6							
27	197	52,69	5690	1,7							
29	179	47,75	5550	1,9							
33	160	42,87	5400	2,1							
38	138	36,93	5190	2,4							
40	130	34,73	5100	2,6							
47	112	29,88	4890	3							
53	100	26,74	4740	3,4	iC 472 – HB2 80 A 4 B16C		24	28	25	29	138
60	87	23,28	4560	3,8							
64	82	21,81	4470	4,1							
23	229	61,18	3560	0,9	iC 373 – HB2 80 A 4 B12C		18	22	20	24	136
25	208	55,76	4120	1							
29	180	48,08	4920	1,15							
31	168	44,81	5170	1,25							
36	146	39,17	5010	1,4							
38	137	36,72	4930	1,5							
43	121	32,4	4780	1,7							
49	107	28,73	4630	1,9							
58	91	24,42	4430	2,2							
63	83	22,27	4320	2,5			iC 372 – HB2 80 A 4 B12C		18	22	20
73	72	19,31	4160	2,8							
78	67	18,05	4080	3							
90	58	15,6	3910	3,5							
106	50	13,25	3730	4							
119	44	11,83	3610	4,3							
36	147	39,25	3180	0,95	iC 273 – HB2 80 A 4 B12C		17	20	17	21	134
38	138	36,79	3210	1							
43	121	32,47	3130	1,15							
49	108	28,78	3050	1,3							
57	91	24,47	2940	1,5							
63	83	22,32	2870	1,65	iC 272 – HB2 80 A 4 B12C		17	20	17	21	134
73	72	19,35	2770	1,9							
78	68	18,08	2730	2							
90	58	15,63	2630	2,3							
106	50	13,28 ⁽¹⁾	2520	2,7							
118	44	11,86	2440	3							
139	38	10,13	2330	3,5							
149	35	9,41	2260	3,5							
172	30	8,16	2170	4							

⁽¹⁾ Finite transmission ratio i

$P_1 = 0,55 \text{ kW}$										
n_2 min ⁻¹	M_2 N m	i	F_{r2} N	fs			foot		flange	
							HB	HBZ	HB	HBZ
184	29	7,63 ⁽¹⁾	2130	4,2	iC 272 – HB2 80 A 4 B12C					
213	25	6,59	2040	4,5			17	20	17	21
251	21	5,6 ⁽¹⁾	1950	4,9						
281	19	5 ⁽¹⁾	1880	5,2						
329	16	4,27	1800	5,6						
351	15	4 ⁽¹⁾	1760	5,8						
417	13	3,37	1670	6,4						

$P_1 = 0,75 \text{ kW}$										
3,6	1969	255,71	25900	1,7	iC 973 – HB3 90 S 6 B30D					
3,9	1858	241,25	27100	1,8			142	146	158	162
4,3	1666	216,28	27500	2						
4,9	1472	289,74	27700	2,3	iC 973 – HB3 80 B 4 B30C					
5,5	1299	255,71	27900	2,6			138	142	154	158
5,8	1226	241,25	28000	2,7						
6,5	1099	216,28	28200	3						
7,6	946	186,3	28300	3,5						
8,3	864	170,02	28400	3,9						
4,3	1668	216,54	11500	1,05	iC 873 – HB3 90 S 6 B25D					
4,5	1584	205,71	12700	1,1			89	93	97	101
5,1	1400	181,77	15300	1,25						
6,0	1196	155,34	18100	1,45						
6,5	1097	142,41	19500	1,6						
5,7	1252	246,54	18800	1,4	iC 873 – HB3 80 B 4 B25C					
6,5	1100	216,54	19500	1,6			85	89	93	97
6,9	1045	205,71	19700	1,65						
7,8	923	181,77	20000	1,9						
9,1	789	155,34	20000	2,2						
9,9	723	142,41	20000	2,4						
11	635	124,97	20000	2,8						
12	602	118,43 ⁽¹⁾	20000	2,9						
14	527	103,65	20000	3,3						
15	474	93,38	20000	3,7						
8,5	846	166,59	9840	1,1	iC 773 – HB3 80 B 4 B20C					
9,7	740	145,67	10700	1,25			51	55	57	61
10	703	138,39	11000	1,3						
12	617	121,42	11500	1,5						
14	523	102,99	12000	1,75						
15	472	92,97	12200	1,9						
17	416	81,8	12500	2,2						
18	392	77,24	12500	2,3						
21	334	65,77	12700	2,7						



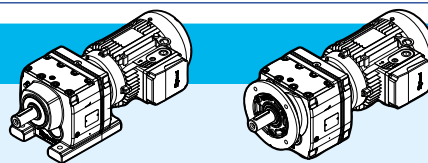

⁽¹⁾ Finite transmission ratio i

$P_1 = 0,75 \text{ kW}$









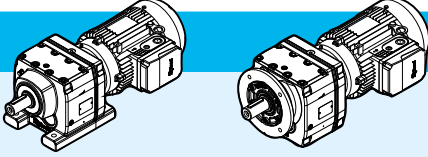

kg

p.

n_2 min ⁻¹	M_2 N m	i	F_{r2} N	fs	iC 773 – HB3 80 B 4 B20C		foot		flange		144
							HB	HBZ	HB	HBZ	
24	293	57,68	12800	3,1			51	55	57	61	
27	265	52,07	12900	3,4							
31	233	45,81	13000	3,8							
33	220	43,26	13000	4							
11	655	128,97	7030	1	iC 673 – HB3 80 B 4 B16C		44	48	46	50	142
12	579	113,94	7940	1,15							
13	538	105,83	8340	1,25							
15	487	95,91	8780	1,4							
16	437	86,11	9150	1,55							
19	377	74,17	9530	1,8							
20	354	69,75	9650	1,9							
23	311	61,26	9860	2,2							
25	289	56,89	9960	2,3							
27	262	51,56	10100	2,5							
30	235	46,29	10200	2,7							
13	541	106,58	5570	0,9	iC 573 – HB3 80 B 4 B16C		35	39	38	42	140
14	503	98,99	6910	0,95							
16	456	89,71	7120	1,05							
18	409	80,55	7300	1,2							
20	352	69,23	7460	1,35							
22	329	64,85	7360	1,45							
25	291	57,29	7150	1,65							
26	270	53,22	7020	1,75							
29	245	48,23	6850	1,95							
33	220	43,3	6670	2,2							
38	189	37,3 ⁽¹⁾	6410	2,5							
40	178	35,07	6310	2,7							
47	153	30,18	6060	3,1							
52	137	26,97	5870	3,4							
54	134	26,31	5830	3,5	iC 572 – HB3 80 B 4 B16C		34	38	37	41	140
56	127	24,99 ⁽¹⁾	5750	3,7							
64	111	21,93	5540	4,2							
76	94	18,6 ⁽¹⁾	5280	4,9							
21	348	68,54	4530	0,95	iC 473 – HB3 80 B 4 B16C		29	33	30	34	138
22	326	64,21	5310	1,05							
25	288	56,73	5510	1,15							
27	268	52,69	5430	1,25							
30	243	47,75	5320	1,4							
33	218	42,87	5180	1,55							
38	188	36,93	5000	1,8							
41	176	34,73	4930	1,9							
47	152	29,88	4740	2,2							
53	136	26,7	4610	2,5							
60	120	23,59	4460	2,8							

⁽¹⁾ Finite transmission ratio i

$P_1 = 0,75 \text{ kW}$											
n_2 min ⁻¹	M_2 N m	i	F_{r2} N	fs		foot		flange			
						HB	HBZ	HB	HBZ		
53	136	26,74	4610	2,5	iC 472 – HB3 80 B 4 B16C		29	33	30	34	138
61	118	23,28	4440	2,8							
65	111	21,81	4360	3							
73	98	19,27	4220	3,3							
79	91	17,89	4130	3,5							
87	82	16,22	4020	3,7							
29	244	48,08	3630	0,85	iC 373 – HB3 80 B 4 B12C		22	26	24	28	136
31	228	44,81	4490	0,9							
36	199	39,17	4760	1,05							
38	187	36,72	4690	1,1							
44	165	32,4	4570	1,25							
49	146	28,73	4440	1,4							
58	124	24,42	4280	1,65							
63	113	22,27	4180	1,8	iC 372 – HB3 80 B 4 B12C		22	26	24	28	136
73	98	19,31	4030	2,1							
78	92	18,05	3960	2,2							
90	79	15,6	3810	2,6							
106	67	13,25	3640	2,9							
119	60	11,83	3530	3,1							
139	51	10,11	3380	3,4							
149	48	9,47	3310	3,6							
49	146	28,78	2860	0,95	iC 273 – HB3 80 B 4 B12C		21	25	21	25	134
58	124	24,47	2770	1,1							
63	113	22,32	2720	1,2	iC 272 – HB3 80 B 4 B12C		21	25	21	25	134
73	98	19,35	2640	1,4							
78	92	18,08	2610	1,5							
90	79	15,63	2520	1,7							
106	67	13,28 ⁽¹⁾	2430	2							
119	60	11,86	2360	2,2							
139	51	10,13	2260	2,6							
150	48	9,41	2180	2,6							
173	41	8,16	2110	3							
185	39	7,63 ⁽¹⁾	2070	3,1							
214	33	6,59	1990	3,3							
252	28	5,6 ⁽¹⁾	1900	3,6							
282	25	5 ⁽¹⁾	1840	3,8							

iC

⁽¹⁾ Finite transmission ratio i

$P_1 = 1,1 \text{ kW}$

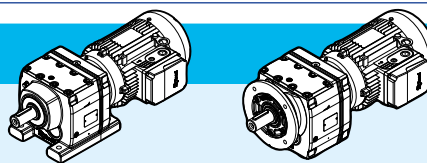









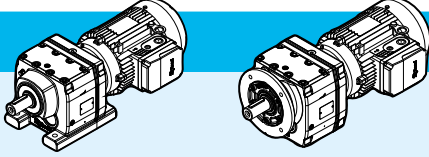

kg

p.

n_2 min ⁻¹	M_2 N m	i	F_{r2} N	fs		foot		flange				
						HB	HBZ	HB	HBZ			
4,3	2443	216,28	20500	1,35	iC 973 – HB3 90 L 6 B30D		146	152	162	168	148	
5,0	2104	186,3	24300	1,6								
5,6	1892	255,71	27000	1,75	iC 973 – HB3 90 S 4 B30D		145	149	161	165	148	
5,9	1785	241,25	27300	1,9								
6,6	1600	216,28	27600	2,1								
7,6	1378	186,3	27900	2,4								
8,4	1258	170,02	28000	2,7								
9,4	1115	150,78	28100	3								
11	938	126,75	28300	3,5								
12	862	116,48	28400	3,8								
6,6	1602	216,54	16800	1,1	iC 873 – HB3 90 S 4 B25D		92	96	100	104	146	
6,9	1522	205,71	17400	1,15								
7,8	1345	181,77	18400	1,3								
9,1	1149	155,34	19300	1,5								
10,0	1054	142,41	19700	1,65								
11	924	124,97	20000	1,9								
12	876	118,43 ⁽¹⁾	20000	2								
14	767	103,65	20000	2,3								
15	691	93,38	20000	2,5								
17	606	81,92	20000	2,9								
20	537	72,57	20000	3,2								
22	471	63,68 ⁽¹⁾	20000	3,7								
24	446	60,35 ⁽¹⁾	20000	3,9								
27	391	52,82	20000	4,4								
12	898	121,42	9360	1	iC 773 – HB3 90 S 4 B20D		57	61	64	68	144	
14	762	102,99	10600	1,2								
15	688	92,97	11100	1,3								
17	605	81,8	11600	1,5								
18	571	77,24	11800	1,6								
22	487	65,77	12200	1,85								
25	427	57,68	12400	2,1								
27	385	52,07	12600	2,3								
31	339	45,81	12700	2,6								
33	320	43,26	12800	2,8								
39	272	36,83	12900	3,2								
42	248	33,47	12900	3,4								
16	637	86,11	7290	1,05	iC 673 – HB3 90 S 4 B16D		50	54	53	57	142	
19	549	74,17	8260	1,2								
20	516	69,75	8550	1,3								
23	453	61,26	9050	1,5								
25	421	56,89	9270	1,6								
28	381	51,56	9510	1,75								
31	342	46,29	9720	1,9								
36	295	39,88 ⁽¹⁾	9940	2,1								

⁽¹⁾ Finite transmission ratio i

$P_1 = 1,1 \text{ kW}$											
n_2 min ⁻¹	M_2 N m	i	F_{r2} N	fs		foot		flange			
						HB	HBZ	HB	HBZ		
38	277	37,5	10000	2,2	iC 673 – HB3 90 S 4 B16D		50	54	53	57	142
44	239	32,27	10200	2,4							
49	213	28,83	10200	2,6							
50	208	28,13	10100	2,8	iC 672 – HB3 90 S 4 B16D		49	53	52	56	142
53	198	26,72	10000	2,8							
61	173	23,44	9620	3,6							
71	147	19,89	9160	4,5							
21	512	69,23	6720	0,95			iC 573 – HB3 90 S 4 B16D		42	46	45
22	480	64,85	6800	1							
25	424	57,29	6660	1,15							
27	394	53,22	6560	1,2							
29	357	48,23	6440	1,35							
33	320	43,3	6290	1,5							
38	276	37,3 ⁽¹⁾	6090	1,7							
40	259	35,07	6000	1,8							
47	223	30,18	5790	2,1							
53	199	26,97	5630	2,4							
54	195	26,31	5600	2,4	iC 572 – HB3 90 S 4 B16D				41	45	44
57	185	24,99 ⁽¹⁾	5530	2,5							
65	162	21,93	5340	2,9							
76	138	18,6 ⁽¹⁾	5110	3,4							
85	124	16,79	4970	3,7							
30	353	47,75	4310	0,95	iC 473 – HB3 90 S 4 B16D		35	39	36	40	138
33	317	42,87	4810	1,05							
38	273	36,93	4680	1,25							
41	257	34,73	4620	1,3							
48	221	29,88	4480	1,5							
53	198	26,7	4370	1,7							
60	175	23,59	4250	1,9							
61	172	23,28	4240	1,95	iC 472 – HB3 90 S 4 B16D		35	39	36	40	138
65	161	21,81	4170	2,1							
74	143	19,27	4040	2,3							
79	132	17,89	3970	2,4							
88	120	16,22	3870	2,5							
98	108	14,56	3760	2,7							
113	93	12,54	3620	3							
120	87	11,79	3550	3,1							
140	75	10,15	3410	3,4							
157	67	9,07	3300	3,6							
44	240	32,4	3040	0,85	iC 373 – HB3 90 S 4 B12D		29	33	31	35	136
49	213	28,73	3410	0,95							
58	181	24,42	3800	1,15							

⁽¹⁾ Finite transmission ratio i

$P_1 = 1,1 \text{ kW}$

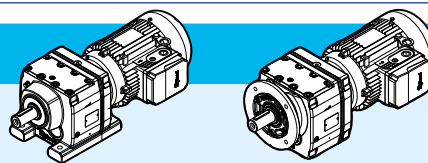







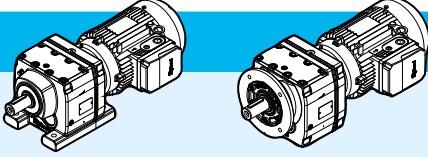

kg

p.

n_2 min ⁻¹	M_2 N m	i	F_{r2} N	fs		foot		flange			
						HB	HBZ	HB	HBZ		
74	143	19,31	3810	1,45	iC 372 – HB3 90 S 4 B12D		28	32	30	34	136
79	134	18,05	3750	1,55							
91	115	15,6	3630	1,8							
107	98	13,25	3490	2							
120	88	11,83	3390	2,2							
140	75	10,11	3260	2,4							
150	70	9,47	3200	2,5							
178	59	7,97	3060	2,7							
213	49	6,67	2890	3							
251	42	5,67	2760	3,5							
281	37	5,06	2670	3,7							
73	143	19,35	2420	0,95	iC 272 – HB3 90 S 4 B12D		27	31	28	32	134
79	134	18,08	2400	1							
91	116	15,63	2340	1,15							
107	98	13,28 ⁽¹⁾	2270	1,35							
120	88	11,86	2220	1,55							
140	75	10,13	2140	1,8							
174	60	8,16	1990	2							
186	56	7,63 ⁽¹⁾	1960	2,1							
215	49	6,59	1900	2,3							
254	41	5,6 ⁽¹⁾	1820	2,5							
284	37	5 ⁽¹⁾	1770	2,6							
332	32	4,27	1700	2,8							
355	30	4 ⁽¹⁾	1670	2,9							
421	25	3,37	1600	3,2							
216	49	13,28 ⁽¹⁾	1950	2,7	iC 272 – HB3 80 B 2 B12C		21	24	21	25	134
242	43	11,86	1890	3							
284	37	10,13	1820	3,3							
305	34	9,41	1750	3,5							
352	30	8,16	1690	3,9							
377	28	7,63 ⁽¹⁾	1660	4							
436	24	6,59	1590	4,4							
513	20	5,6 ⁽¹⁾	1520	4,8							
575	18	5 ⁽¹⁾	1480	5,2							
673	16	4,27	1410	5,6							
719	15	4 ⁽¹⁾	1380	5,8							
853	12	3,37	1320	6,4							

⁽¹⁾ Finite transmission ratio i

$P_1 = 1,5 \text{ kW}$											
n_2 min ⁻¹	M_2 N m	i	F_{r2} N	fs		foot		flange			
						HB	HBZ	HB	HBZ		
5,6	2562	255,71	24000	1,3	iC 973 – HB3 90 L 4 B30D		145	151	161	167	148
5,9	2417	241,25	24800	1,4							
6,6	2167	216,28	25900	1,55							
7,7	1866	186,3	27000	1,8							
8,4	1703	170,02	27400	1,95							
9,5	1510	150,78	27700	2,2							
11	1270	126,75	28000	2,6							
12	1167	116,48	28100	2,8							
14	1036	103,44	28200	3,1							
15	926	92,48	28300	3,5							
7,9	1821	181,77	15100	0,95	iC 873 – HB3 90 L 4 B25D		92	98	100	106	146
9,2	1556	155,34	17100	1,1							
10	1427	142,41	17900	1,25							
11	1252	124,97	18800	1,4							
12	1186	118,43 ⁽¹⁾	19200	1,5							
14	1038	103,65	19800	1,7							
15	935	93,38	20000	1,85							
17	821	81,92	20000	2,1							
20	727	72,57	20000	2,4							
22	638	63,68 ⁽¹⁾	20000	2,7							
24	605	60,35 ⁽¹⁾	20000	2,9							
27	529	52,82	20000	3,2							
30	477	47,58	20000	3,6							
34	418	41,74	20000	4,1							
39	369	36,84 ⁽¹⁾	19400	4,6							
15	931	92,97	8980	1	iC 773 – HB3 90 L 4 B20D		58	64	64	70	144
17	819	81,8	10100	1,1							
19	774	77,24	10500	1,15							
22	659	65,77	11300	1,35							
25	578	57,68	11700	1,55							
27	522	52,07	12000	1,7							
31	459	45,81	12300	1,95							
33	433	43,26	12400	2							
39	369	36,83	12600	2,4							
43	335	33,47	12700	2,5							
49	290	29	12400	2,9							
57	253	25,23	11900	3,1							
61	234	23,37	11600	3,6	iC 772 – HB3 90 L 4 B20D		56	62	63	69	144
67	215	21,43	11400	3,9							
76	188	18,8	10900	4,2							
23	614	61,26	7550	1,1	iC 673 – HB3 90 L 4 B16D		51	57	53	59	142
25	570	56,89	8030	1,2							
28	517	51,56	8530	1,3							
31	464	46,29	8960	1,4							





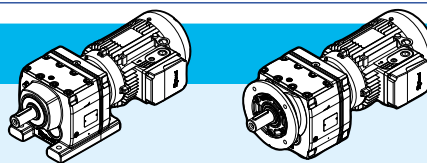

⁽¹⁾ Finite transmission ratio i

$P_1 = 1,5 \text{ kW}$









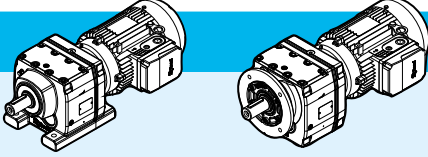

kg

p.

n_2 min ⁻¹	M_2 N m	i	F_{r2} N	fs		foot		flange			
						HB	HBZ	HB	HBZ		
36	399	39,88 ⁽¹⁾	9390	1,55	iC 673 – HB3 90 L 4 B16D		51	57	53	59	142
38	376	37,5	9530	1,6							
44	323	32,27	9810	1,75							
50	289	28,83	9960	1,9							
51	282	28,13	9890	2,1	iC 672 – HB3 90 L 4 B16D		50	56	53	59	142
54	268	26,72	9760	2,1							
61	235	23,44	9410	2,7							
72	199	19,89	8980	3,3							
80	180	17,95	8720	3,5							
27	533	53,22	5900	0,9	iC 573 – HB3 90 L 4 B16D		42	48	45	51	140
30	483	48,23	5980	1							
33	434	43,3	5880	1,1							
38	374	37,3 ⁽¹⁾	5730	1,25							
41	351	35,07	5670	1,35							
47	302	30,18	5500	1,55							
53	270	26,97	5380	1,75							
54	264	26,31	5350	1,8	iC 572 – HB3 90 L 4 B16D		41	47	44	50	140
57	250	24,99 ⁽¹⁾	5290	1,85							
65	220	21,93	5130	2,1							
77	186	18,6 ⁽¹⁾	4930	2,5							
85	168	16,79	4810	2,7							
97	148	14,77 ⁽¹⁾	4650	3,1							
103	140	13,95 ⁽¹⁾	4580	3,3							
120	119	11,88	4390	3,8							
39	370	36,93	3260	0,9	iC 473 – HB3 90 L 4 B16D		36	42	37	43	138
41	348	34,73	4290	0,95							
48	299	29,88	4190	1,1							
54	267	26,7	4110	1,25							
61	236	23,59	4020	1,4							
61	233	23,28	4010	1,45	iC 472 – HB3 90 L 4 B16D		36	42	37	43	138
66	218	21,81	3960	1,55							
74	193	19,27	3860	1,7							
80	179	17,89	3800	1,75							
88	162	16,22	3710	1,85							
98	146	14,56	3620	2							
114	126	12,54	3490	2,2							
121	118	11,79	3440	2,3							
141	102	10,15	3310	2,5							
158	91	9,07	3210	2,6							
178	80	8,01	3110	2,8			35	41	36	42	
184	78	7,76 ⁽¹⁾	3040	2,4							
205	70	6,96	2950	2,6							
238	60	6	2830	2,9							
254	56	5,64 ⁽¹⁾	2780	3,1							

⁽¹⁾ Finite transmission ratio i

$P_1 = 1,5 \text{ kW}$												
n_2 min ⁻¹	M_2 N m	i	F_{r2} N	fs		foot		flange				
						HB	HBZ	HB	HBZ			
295	49	4,85	2670	3,5	iC 472 – HB3 90 L 4 B16D		35	41	36	42	138	
330	43	4,34	2590	3,8								
373	38	3,83	2500	4,2								
74	193	19,31	2760	1,05	iC 372 – HB3 90 L 4 B12D		29	35	31	37	136	
79	181	18,05	2930	1,15								
92	156	15,6	3230	1,3								
108	133	13,25	3320	1,5								
121	119	11,83	3240	1,6								
141	101	10,11	3130	1,75								
151	95	9,47	3080	1,8								
179	80	7,97	2950	2								
214	67	6,67	2800	2,2								
252	57	5,67	2680	2,6								
283	51	5,06	2600	2,7								
331	43	4,32	2490	3								
353	41	4,05	2450	3,1								
419	34	3,41	2330	3,4								
218	66	13,25	2830	2,9	iC 372 – HB3 90 S 2 B12D		26	30	28	32	136	
244	59	11,83	2740	3,1								
286	50	10,11	2630	3,4								
305	47	9,47	2580	3,6								
362	40	7,97	2460	3,9								
91	157	15,63	1780	0,85	iC 272 – HB3 90 L 4 B12D		28	34	28	34	134	
108	133	13,28 ⁽¹⁾	2080	1								
121	119	11,86	2060	1,15								
141	101	10,13	2010	1,3								
175	82	8,16	1870	1,5								
188	76	7,63 ⁽¹⁾	1850	1,55								
217	66	6,59	1800	1,65								
255	56	5,6 ⁽¹⁾	1740	1,8								
286	50	5 ⁽¹⁾	1700	1,95								
335	43	4,27	1640	2,1								
358	40	4 ⁽¹⁾	1610	2,2								
424	34	3,37	1540	2,4								
244	59	11,86	1810	2,2	iC 272 – HB3 90 S 2 B12D		25	29	25	29	134	
285	50	10,13	1750	2,4								
354	40	8,16	1620	2,9								
379	38	7,63 ⁽¹⁾	1600	3								
438	33	6,59	1540	3,2								
516	28	5,6 ⁽¹⁾	1480	3,6								
578	25	5 ⁽¹⁾	1430	3,8								
677	21	4,27	1370	4,1								
723	20	4 ⁽¹⁾	1350	4,3								
858	17	3,37	1290	4,7								

⁽¹⁾ Finite transmission ratio i

$P_1 = 2,2 \text{ kW}$

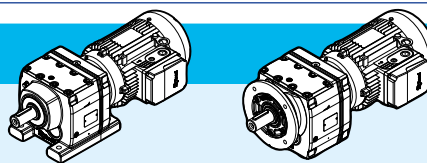







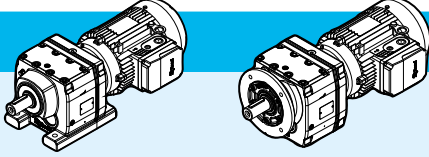

kg

p.

n_2 min ⁻¹	M_2 N m	i	F_{r2} N	fs		foot		flange			
						HB	HBZ	HB	HBZ		
6,7	3156	216,28	13800	1,05	iC 973 – HB3 100 LA 4 B30E		153	159	169	175	148
7,7	2718	186,3	22900	1,25							
8,5	2481	170,02	24300	1,35							
9,6	2200	150,78	25600	1,5							
11	1849	126,75	27000	1,8							
12	1699	116,48	27400	1,95							
14	1509	103,44	27600	2,2							
16	1349	92,48	27900	2,4							
17	1213	83,15	28000	2,7							
20	1053	72,17	28200	3,1							
22	951	65,21	27500	3,4							
24	874	59,92	26800	3,7							
27	776	53,21	25900	4,1							
30	694	47,58	25000	4,6							
12	1823	124,97	13900	0,95	iC 873 – HB3 100 LA 4 B25E		102	108	110	116	146
12	1728	118,43 ⁽¹⁾	15700	1							
14	1512	103,65	17300	1,15							
15	1362	93,38	18200	1,3							
18	1195	81,92	19000	1,45							
20	1059	72,57	19600	1,65							
23	929	63,68 ⁽¹⁾	20000	1,85							
24	881	60,35 ⁽¹⁾	20000	1,95							
27	771	52,82	20000	2,2							
30	694	47,58	20000	2,5							
34	609	41,74	19700	2,8							
39	537	36,84 ⁽¹⁾	19000	3,2							
44	476	32,66 ⁽¹⁾	18400	3,5							
42	502	34,4 ⁽¹⁾	18700	3,4	iC 872 – HB3 100 LA 4 B25E		100	106	108	114	146
46	458	31,4	18200	3,7							
52	406	27,84 ⁽¹⁾	17500	4,1							
62	341	23,4	16700	4,6							
67	314	21,51	16200	4,9							
22	960	65,77	7900	0,95	iC 773 – HB3 100 LA 4 B20E		67	73	74	80	144
25	842	57,68	9770	1,05							
28	760	52,07	10500	1,15							
31	668	45,81	11200	1,35							
33	631	43,26	11400	1,4							
39	537	36,83	11900	1,65							
43	488	33,47	12100	1,75							
50	423	29	12000	1,95							
57	368	25,23	11600	2,1							
62	341	23,37	11400	2,4			iC 772 – HB3 100 LA 4 B20E		66	72	73
67	313	21,43	11100	2,6							
77	274	18,8	10700	2,9							

⁽¹⁾ Finite transmission ratio i

$P_1 = 2,2 \text{ kW}$												
n_2 min ⁻¹	M_2 N m	i	F_{r2} N	fs		foot		flange				
						HB	HBZ	HB	HBZ			
81	260	17,82 ⁽¹⁾	10500	3	iC 772 – HB3 100 LA 4 B20E		66	72	73	79	144	
92	228	15,6	10100	3,3								
102	205	14,05	9830	3,5								
36	582	39,88 ⁽¹⁾	7820	1,05	iC 673 – HB3 100 LA 4 B16E		60	66	63	69	142	
38	547	37,5	8180	1,1								
45	471	32,27	8850	1,2								
50	421	28,83	9220	1,3								
61	342	23,44	9070	1,85								
72	290	19,89	8700	2,3	iC 672 – HB3 100 LA 4 B16E		59	65	62	68	142	
80	262	17,95	8470	2,4								
91	230	15,79	8180	2,6								
97	218	14,91	8050	2,7								
113	185	12,7	7700	2,9								
125	168	11,54	7500	3,1								
144	146	10	7190	3,3								
166	127	8,7 ⁽¹⁾	6910	3,5								
185	114	7,79	6700	3,4					57	63	60	66
39	544	37,3 ⁽¹⁾	5120	0,85			iC 573 – HB3 100 LA 4 B16E		52	58	55	61
41	512	35,07	5100	0,9								
48	440	30,18	5010	1,05								
53	393	26,97	4940	1,2								
66	320	21,93	4780	1,45	iC 572 – HB3 100 LA 4 B16E		51	57	54	60	140	
77	271	18,6 ⁽¹⁾	4630	1,7								
86	245	16,79	4540	1,9								
97	216	14,77 ⁽¹⁾	4420	2,1								
103	204	13,95 ⁽¹⁾	4360	2,3								
121	173	11,88	4210	2,6								
133	157	10,79	4110	2,8								
154	136	9,35	3970	3								
159	132	9,06	3950	2,9					49	55	52	58
181	116	7,97	3820	3,1								
132	159	21,93	4120	2,9	iC 572 – HB3 90 LA 2 B16D		40	46	43	49	140	
155	135	18,6 ⁽¹⁾	3960	3,4								
172	122	16,79	3860	3,7								
196	107	14,77 ⁽¹⁾	3730	4,1								
207	101	13,95 ⁽¹⁾	3680	4,3								
75	281	19,27	3540	1,15	iC 472 – HB3 100 LA 4 B16E		45	51	46	52	138	
89	237	16,22	3450	1,3								
99	212	14,56	3380	1,35								
115	183	12,54	3290	1,5								
122	172	11,79	3250	1,55								
142	148	10,15	3140	1,7								
159	132	9,07	3070	1,8								
180	117	8,01	2980	1,95								



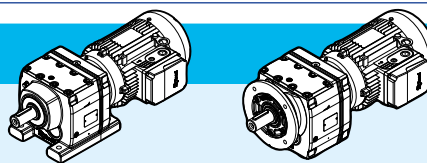

⁽¹⁾ Finite transmission ratio i

$P_1 = 2,2 \text{ kW}$









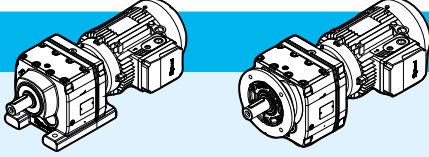

kg

p.

n_2 min ⁻¹	M_2 N m	i	F_{r2} N	fs		foot		flange			
						HB	HBZ	HB	HBZ		
186	113	7,76 ⁽¹⁾	2890	1,65	iC 472 – HB3 100 LA 4 B16E		45	51	46	52	138
207	102	6,96	2820	1,75							
240	88	6	2720	2							
255	82	5,64 ⁽¹⁾	2680	2,1							
297	71	4,85	2580	2,4							
332	63	4,34	2510	2,6							
376	56	3,83	2430	2,9							
150	140	19,27	3110	2,1	iC 472 – HB3 90 LA 2 B16D		35	41	36	42	138
178	118	16,22	2980	2,3							
198	106	14,56	2910	2,5							
230	91	12,54	2800	2,8							
245	86	11,79	2760	2,9							
285	74	10,15	2650	3,1							
319	66	9,07	2570	3,4							
361	58	8,01	2490	3,5			34	40	35	41	
92	228	15,6	1180	0,9	iC 372 – HB3 100 LA 4 B12E		37	43	39	45	136
109	193	13,25	1740	1							
122	173	11,83	2060	1,1							
142	147	10,11	2410	1,2							
152	138	9,47	2530	1,25							
181	116	7,97	2790	1,35							
216	97	6,67	2500	1,5							
254	83	5,67	2550	1,75							
285	74	5,06	2490	1,85							
333	63	4,32	2400	2							
356	59	4,05	2360	2,1							
422	50	3,41	2260	2,3							
185	113	15,6	2770	1,75	iC 372 – HB3 90 LA 2 B12D		28	34	30	36	136
218	96	13,25	2680	2							
244	86	11,83	2610	2,1							
286	73	10,11	2520	2,3							
305	69	9,47	2480	2,4							
362	58	7,97	2370	2,7							
433	48	6,67	2240	3							
510	41	5,67	2150	3,5							
571	37	5,06	2080	3,7							
669	31	4,32	1990	4							
714	29	4,05	1960	4,2							
848	25	3,41	1860	4,5							
142	148	10,13	1180	0,9	iC 272 – HB3 100 LA 4 B12E		36	42	37	43	134
218	96	6,59	1180	1,15							
257	82	5,6 ⁽¹⁾	1430	1,25							
288	73	5 ⁽¹⁾	1570	1,3							

⁽¹⁾ Finite transmission ratio i

$P_1 = 2,2 \text{ kW}$											
n_2	M_2	i	F_{r2}	fs	iC 272 – HB3 100 LA 4 B12E		foot		flange		
min ⁻¹	N m		N	HB			HBZ	HB	HBZ		
337	62	4,27	1530	1,4			36	42	37	43	134
360	58	4 ⁽¹⁾	1510	1,45							
427	49	3,37	1460	1,6							
218	97	13,28 ⁽¹⁾	1700	1,35	iC 272 – HB3 90 LA 2 B12D		27	33	27	33	134
244	86	11,86	1680	1,5							
285	74	10,13	1630	1,65							
438	48	6,59	1450	2,2							
516	41	5,6 ⁽¹⁾	1400	2,4							
578	36	5 ⁽¹⁾	1360	2,6							
677	31	4,27	1320	2,8							
723	29	4 ⁽¹⁾	1290	2,9							
858	24	3,37	1240	3,2							

$P_1 = 3 \text{ kW}$											
9,6	2979	150,78	21000	1,1	iC 973 – HB3 112 MA 4 B30E		160	166	176	182	148
11	2504	126,75	24100	1,3							
12	2301	116,48	25100	1,4							
14	2044	103,44	26200	1,6							
16	1827	92,48	27100	1,8							
17	1643	83,15	27400	1,95							
20	1426	72,17	27500	2,3							
22	1288	65,21	26700	2,5							
24	1184	59,92	26100	2,7							
27	1051	53,21	25300	3							
30	940	47,58	24500	3,4							
34	845	42,78	23800	3,8							
39	734	37,13	22800	4,2							
44	657	33,25	22100	4,5							
16	1845	93,38	12100	0,95	iC 873 – HB3 112 MA 4 B25E		110	116	118	124	146
18	1619	81,92	16500	1,05							
20	1434	72,57	17700	1,2							
23	1258	63,68 ⁽¹⁾	18700	1,35							
24	1192	60,35 ⁽¹⁾	19000	1,45							
27	1044	52,82	19700	1,65							
30	940	47,58	19800	1,8							
35	825	41,74	19200	2,1							
39	728	36,84 ⁽¹⁾	18500	2,3							
44	645	32,66 ⁽¹⁾	17900	2,6							
52	551	27,88	17200	3							
42	680	34,4 ⁽¹⁾	18200	2,5	iC 872 – HB3 112 MA 4 B25E		108	114	116	122	146
46	620	31,4	17700	2,7							
52	550	27,84 ⁽¹⁾	17200	3							
62	462	23,4	16300	3,4							





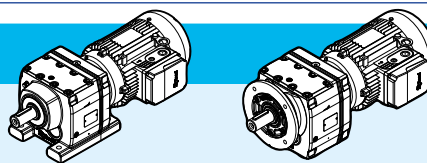

⁽¹⁾ Finite transmission ratio i

$P_1 = 3 \text{ kW}$









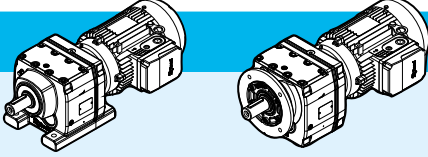

kg

p.

n_2 min ⁻¹	M_2 N m	i	F_{r2} N	fs		foot		flange										
						HB	HBZ	HB	HBZ									
67	425	21,51	15900	3,6	iC 872 – HB3 112 MA 4 B25E		108	114	116	122	146							
76	377	19,1	15400	3,9														
85	337	17,08 ⁽¹⁾	14900	4,2														
94	303	15,35	14400	4,5														
32	905	45,81	9090	1	iC 773 – HB3 112 MA 4 B20E		76	82	83	89	144							
34	855	43,26	9620	1,05														
39	728	36,83	10700	1,2														
43	661	33,47	11200	1,3														
50	573	29	11600	1,45														
57	499	25,23	11200	1,55														
62	462	23,37	11000	1,8	iC 772 – HB3 112 MA 4 B20E		75	81	82	88	144							
68	423	21,43	10700	1,95														
77	372	18,8	10400	2,1														
81	352	17,82 ⁽¹⁾	10200	2,2														
93	308	15,6	9870	2,4														
103	278	14,05	9600	2,6														
118	244	12,33	9250	2,9														
133	215	10,88	8930	3,1														
150	191	9,64	8620	3,3														
169	170	8,59	8400	3,7														
187	153	7,74	8140	4														
214	134	6,79	7830	4,3														
62	463	23,44	8660	1,35								iC 672 – HB3 112 MA 4 B16E		67	73	69	75	142
73	393	19,89	8350	1,65														
81	355	17,95	8150	1,8														
92	312	15,79	7900	1,95														
97	295	14,91	7790	2														
114	251	12,7	7470	2,2														
126	228	11,54	7290	2,3														
145	198	10	7010	2,4														
54	533	26,97	4430	0,9	iC 573 – HB3 112 MA 4 B16E		59	65	62	68	140							
66	433	21,93	4360	1,1	iC 572 – HB3 112 MA 4 B16E		58	64	61	67	140							
78	368	18,6 ⁽¹⁾	4280	1,25														
86	332	16,79	4220	1,4														
98	292	14,77 ⁽¹⁾	4140	1,6														
104	276	13,95 ⁽¹⁾	4100	1,65														
122	235	11,88	3980	1,9														
134	213	10,79	3900	2														
155	185	9,35	3790	2,2														
160	179	9,06	3780	2,2														
182	158	7,97	3670	2,3														
193	149	7,53	3620	2,4														
226	127	6,41	3480	2,7														

⁽¹⁾ Finite transmission ratio i

$P_1 = 3 \text{ kW}$							 kg		 p.				
n_2 min ⁻¹	M_2 N m	i	F_{r2} N	fs			foot		flange				
							HB	HBZ	HB	HBZ			
249	115	5,82	3400	2,8	iC 572 – HB3 112 MA 4 B16E		56	62	60	66	140		
287	100	5,05	3270	3,1									
330	87	4,39	3160	3,2									
134	214	21,93	3920	2,1	iC 572 – HB3 100 LA 2 B16E		49	55	52	58	140		
158	182	18,6 ⁽¹⁾	3790	2,5									
174	164	16,79	3700	2,7									
198	144	14,77 ⁽¹⁾	3600	3									
210	136	13,95 ⁽¹⁾	3550	3,2									
247	116	11,88	3410	3,5									
271	106	10,79	3330	3,7									
89	320	16,22	2210	0,95			iC 472 – HB3 112 MA 4 B16E		53	59	54	60	138
100	288	14,56	2650	1									
116	248	12,54	3040	1,1									
123	233	11,79	3020	1,15									
143	201	10,15	2950	1,25									
160	179	9,07	2890	1,35									
181	158	8,01	2820	1,45					52	58	53	59	
187	153	7,76 ⁽¹⁾	2720	1,2									
208	138	6,96	2660	1,3									
242	119	6	2590	1,5									
257	111	5,64 ⁽¹⁾	2550	1,55									
299	96	4,85	2470	1,75									
334	86	4,34	2410	1,95									
378	76	3,83	2340	2,1									
248	115	11,79	2650	2,1	iC 472 – HB3 100 LA 2 B16E				43	49	44	50	138
289	99	10,15	2560	2,3									
323	89	9,07	2490	2,5									
366	78	8,01	2410	2,6									
378	76	7,76 ⁽¹⁾	2350	2,3									
421	68	6,96	2290	2,5									
489	59	6	2200	2,7									
520	55	5,64 ⁽¹⁾	2170	2,8									
604	47	4,85	2080	3,2									
676	42	4,34	2020	3,4									
765	37	3,83	1950	3,8									
143	200	10,11	920	0,9	iC 372 – HB3 112 MA 4 B12E		46	52	48	54	136		
153	187	9,47	1140	0,9									
182	158	7,97	1610	1									
217	132	6,67	1350	1,1					45	51	47	53	
256	112	5,67	1700	1,25									
287	100	5,06	1900	1,35									
336	85	4,32	2110	1,5									
358	80	4,05	2180	1,55									
425	67	3,41	2160	1,65									

⁽¹⁾ Finite transmission ratio i

$P_1 = 3 \text{ kW}$

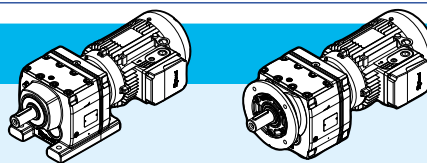

kg







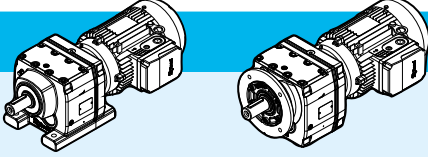

p.

n_2 min ⁻¹	M_2 N m	i	F_{r2} N	fs		foot		flange			
						HB	HBZ	HB	HBZ		
290	99	10,11	2380	1,7	iC 372 – HB3 100 LA 2 B12E		35	41	37	43	136
310	93	9,47	2360	1,8							
367	78	7,97	2270	2							
439	65	6,67	2150	2,2							
517	55	5,67	2070	2,6							
579	49	5,06	2020	2,7							
678	42	4,32	1940	3							
724	40	4,05	1900	3,1							
859	33	3,41	1820	3,4							
259	111	5,6 ⁽¹⁾	455	0,9	iC 272 – HB3 112 MA 4 B12E		45	51	45	51	134
290	99	5 ⁽¹⁾	695	0,95							
340	84	4,27	970	1,05							
363	79	4 ⁽¹⁾	1070	1,1							
430	67	3,37	1280	1,2							
445	64	6,59	1290	1,65	iC 272 – HB3 100 LA 2 B12E		34	40	35	41	134
523	55	5,6 ⁽¹⁾	1320	1,8							
586	49	5 ⁽¹⁾	1290	1,95							
686	42	4,27	1250	2,1							
733	39	4 ⁽¹⁾	1240	2,2							
870	33	3,37	1190	2,4							

$P_1 = 4 \text{ kW}$

12	3069	116,48	18300	1,05	iC 973 – HB3 112 M 4 B30F		162	171	178	187	148
14	2725	103,44	22900	1,2							
16	2436	92,48	24500	1,35							
17	2191	83,15	25700	1,5							
20	1901	72,17	26500	1,7							
22	1718	65,21	25800	1,85							
24	1579	59,92	25300	2							
27	1402	53,21	24600	2,3							
30	1253	47,58	23800	2,5							
34	1127	42,78	23200	2,8							
39	978	37,13	22300	3,2							
44	876	33,25	21600	3,4							
45	844	32,05	21400	3,4			iC 972 – HB3 112 M 4 B30F		158	167	
53	716	27,19	20400	4							
58	659	25,03	20000	4,4							
65	589	22,37	19300	4,8							
72	531	20,14	18700	5,1							
23	1678	63,68 ⁽¹⁾	13700	1,05	iC 873 – HB3 112 M 4 B25F		112	121	120	129	146
24	1590	60,35 ⁽¹⁾	14300	1,1							
27	1391	52,82	15500	1,25							
30	1254	47,58	16300	1,35							

⁽¹⁾ Finite transmission ratio i

$P_1 = 4 \text{ kW}$												
n_2 min ⁻¹	M_2 N m	i	F_{r2} N	fs		foot		flange				
						HB	HBZ	HB	HBZ			
35	1100	41,74	17000	1,55	iC 873 – HB3 112 M 4 B25F		112	121	120	129	146	
39	970	36,84 ⁽¹⁾	17500	1,75								
44	860	32,66 ⁽¹⁾	17400	1,95								
52	735	27,88	16700	2,2								
42	906	34,4 ⁽¹⁾	17600	1,85	iC 872 – HB3 112 M 4 B25F		110	119	118	127	146	
46	827	31,4	17200	2								
52	734	27,84 ⁽¹⁾	16700	2,3								
62	617	23,4	15900	2,6								
67	567	21,51	15600	2,7								
76	503	19,1	15100	2,9								
85	450	17,08 ⁽¹⁾	14600	3,2								
94	405	15,35	14200	3,4								
109	351	13,33	13600	3,7								
122	314	11,93	13200	4								
39	970	36,83	7260	0,9	iC 773 – HB3 112 M 4 B20F		78	87	85	94	144	
43	882	33,47	9400	0,95								
50	764	29	10500	1,1								
57	665	25,23	10700	1,2								
62	616	23,37	10500	1,35	iC 772 – HB3 112 M 4 B20F		77	86	84	93	144	
68	565	21,43	10300	1,45								
77	495	18,8	10000	1,6								
81	469	17,82 ⁽¹⁾	9880	1,7								
93	411	15,6	9560	1,8								
103	370	14,05	9310	1,95								
118	325	12,33	9000	2,1								
133	287	10,88	8700	2,3								
150	254	9,64	8420	2,5					74	83	80	89
169	226	8,59	8240	2,8								
187	204	7,74	8000	3								
214	179	6,79	7700	3,3								
242	158	5,99 ⁽¹⁾	7420	3,5								
273	140	5,31 ⁽¹⁾	7160	3,7								
73	524	19,89	7910	1,25	iC 672 – HB3 112 M 4 B16F		69	78	71	80	142	
81	473	17,95	7750	1,35								
92	416	15,79	7550	1,45								
97	393	14,91	7460	1,5								
114	335	12,7	7190	1,6								
126	304	11,54	7030	1,7								
145	263	10	6790	1,8								
167	229	8,7 ⁽¹⁾	6550	1,95								
186	205	7,79	6390	1,85					67	76	70	79
197	194	7,36 ⁽¹⁾	6290	1,95								
231	165	6,27	6020	2								
255	150	5,7	5860	2,1								



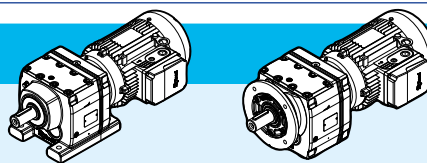

⁽¹⁾ Finite transmission ratio i

$P_1 = 4 \text{ kW}$









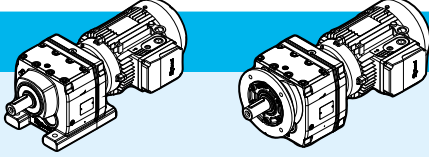

kg

p.

n_2 min ⁻¹	M_2 N m	i	F_{r2} N	fs		foot		flange				
						HB	HBZ	HB	HBZ			
294	130	4,93	5630	2,2	iC 672 – HB3 112 M 4 B16F		67	76	70	79	142	
338	113	4,29	5410	2,4								
78	490	18,6 ⁽¹⁾	3680	0,95	iC 572 – HB3 112 M 4 B16F		60	69	63	72	140	
86	442	16,79	3820	1,05								
98	389	14,77 ⁽¹⁾	3790	1,2								
104	368	13,95 ⁽¹⁾	3770	1,25								
122	313	11,88	3700	1,45								
134	284	10,79	3650	1,55								
155	246	9,35	3560	1,65								
160	239	9,06	3570	1,6					58	67	62	71
182	210	7,97	3480	1,75								
193	198	7,53	3440	1,8								
226	169	6,41	3330	2								
249	153	5,82	3260	2,1								
287	133	5,05	3160	2,3								
330	116	4,39	3050	2,4								
143	267	10,15	2070	0,95	iC 472 – HB3 112 M 4 B16F		55	64	56	65	138	
160	239	9,07	2450	1								
181	211	8,01	2630	1,1					54	63	55	64
208	183	6,96	2470	1								
242	158	6	2420	1,1								
257	149	5,64 ⁽¹⁾	2400	1,2								
299	128	4,85	2340	1,35								
334	114	4,34	2290	1,45								
378	101	3,83	2230	1,6								
181	211	16,22	2630	1,3	iC 472 – HB3 112 M 2 B16F		53	59	54	60	138	
202	189	14,56	2590	1,4								
234	163	12,54	2520	1,55								
249	153	11,79	2500	1,6								
290	132	10,15	2430	1,75								
324	118	9,07	2370	1,85								
367	104	8,01	2310	1,95					52	58	53	59
379	101	7,76 ⁽¹⁾	2230	1,75								
422	90	6,96	2180	1,85								
490	78	6	2110	2								
521	73	5,64 ⁽¹⁾	2080	2,1								
606	63	4,85	2010	2,4								
678	56	4,34	1950	2,6								
767	50	3,83	1890	2,9								

⁽¹⁾ Finite transmission ratio i

$P_1 = 5,5 \text{ kW}$											
n_2 min ⁻¹	M_2 N m	i	F_{r2} N	fs		foot		flange			
						HB	HBZ	HB	HBZ		
18	2971	83,15	20000	1,1	iC 973 – HB3 132 S 4 B30G		186	197	202	213	148
20	2579	72,17	22100	1,25							
23	2330	65,21	24600	1,4							
25	2141	59,92	24100	1,5							
28	1901	53,21	23500	1,7							
31	1700	47,58	22900	1,85							
34	1528	42,78	22400	2,1							
40	1327	37,13	21600	2,3							
44	1188	33,25	21000	2,5							
53	986	27,58	20000	2,8							
46	1145	32,05	20800	2,5	iC 972 – HB3 132 S 4 B30G		182	193	198	209	148
54	971	27,19	19900	3							
59	894	25,03	19500	3,3							
66	799	22,37	18900	3,5							
73	720	20,14	18300	3,8							
81	652	18,24	17800	4,1							
91	578	16,17	17200	4,4							
31	1700	47,58	15700	1			iC 873 – HB3 132 S 4 B25G		137	148	144
35	1492	41,74	17300	1,15							
40	1316	36,84 ⁽¹⁾	17100	1,3							
45	1167	32,66 ⁽¹⁾	16600	1,45							
53	996	27,88	16100	1,65							
53	995	27,84 ⁽¹⁾	16000	1,7	iC 872 – HB3 132 S 4 B25G		135	146	143	154	146
63	836	23,4	15400	1,9							
68	769	21,51	15100	2							
77	682	19,1	14600	2,2							
86	610	17,08 ⁽¹⁾	14200	2,3							
96	549	15,35	13800	2,5							
110	476	13,33	13300	2,7							
123	426	11,93	12900	2,9							
148	354	9,9 ⁽¹⁾	12200	3,3							
161	327	9,14 ⁽¹⁾	12100	3,7							
179	294	8,22	11700	3,9							
206	255	7,13	11200	4,2							
78	672	18,8	9320	1,15			iC 772 – HB3 132 S 4 B20G		100	111	106
82	637	17,82 ⁽¹⁾	9360	1,25							
94	557	15,6	9110	1,35							
105	502	14,05	8910	1,45							
119	440	12,33	8650	1,55							
135	389	10,88	8390	1,7							
152	345	9,64	8150	1,85							
171	307	8,59	8030	2,1							
190	277	7,74	7810	2,2							
216	243	6,79	7530	2,4							

⁽¹⁾ Finite transmission ratio i

$P_1 = 5,5 \text{ kW}$

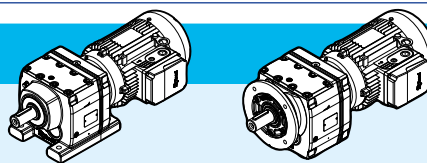







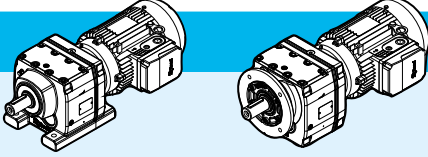

kg

p.

n_2 min ⁻¹	M_2 N m	i	F_{r2} N	fs		foot		flange					
						HB	HBZ	HB	HBZ				
245	214	5,99 ⁽¹⁾	7270	2,5	iC 772 – HB3 132 S 4 B20G		96	107	103	114	144		
277	190	5,31 ⁽¹⁾	7030	2,7									
93	564	15,79	6720	1,05	iC 672 – HB3 132 S 4 B16G		92	103	95	106	142		
99	533	14,91	6980	1,1									
116	454	12,7	6790	1,2									
127	412	11,54	6660	1,25									
147	357	10	6470	1,35									
169	311	8,7 ⁽¹⁾	6280	1,4									
189	279	7,79	6150	1,35					90	101	93	104	
200	263	7,36 ⁽¹⁾	6070	1,4									
235	224	6,27	5830	1,45									
258	203	5,7	5690	1,5									
298	176	4,93	5480	1,65									
342	153	4,29	5280	1,75									
340	154	8,7 ⁽¹⁾	5280	2,9	iC 672 – HB3 132 S 2 B16G		87	98	90	101	142		
380	138	7,79	5140	2,7					85	96	88	99	
402	131	7,36 ⁽¹⁾	5060	2,8									
472	111	6,27	4830	3									
520	101	5,7	4700	3,1									
600	88	4,93	4510	3,3									
689	76	4,29	4330	3,5									
100	528	14,77 ⁽¹⁾	1860	0,85			iC 572 – HB3 132 S 4 B16G		84	95	87	98	140
105	498	13,95 ⁽¹⁾	2200	0,9									
124	424	11,88	3000	1,05									
136	386	10,79	3270	1,15									
157	334	9,35	3240	1,25									
184	285	7,97	3210	1,3					82	93	85	96	
195	269	7,53	3190	1,3									
229	229	6,41	3110	1,45									
252	208	5,82	3060	1,55									
291	180	5,05	2980	1,7									
335	157	4,39	2900	1,8									
317	166	9,35	2920	2,2	iC 572 – HB3 132 S 2 B16G		79	90	82	93	140		
371	141	7,97	2840	2,5					77	88	80	91	
393	134	7,53	2800	2,6									
462	114	6,41	2700	2,9									
508	103	5,82	2640	3,1									
587	90	5,05	2550	3,4									
674	78	4,39	2460	3,6									
303	173	4,85	1920	1			iC 472 – HB3 132 S 4 B16G		78	89	79	90	138
339	155	4,34	2110	1,05									
384	137	3,83	2070	1,15									

⁽¹⁾ Finite transmission ratio i

$P_1 = 5,5 \text{ kW}$											
n_2 min ⁻¹	M_2 N m	i	F_{r2} N	fs		foot	flange				
						HB	HBZ	HB	HBZ		
236	223	12,54	1780	1,1	iC 472 – HB3 132 S 2 B16G		73	84	74	85	138
251	209	11,79	1970	1,15							
292	180	10,15	2250	1,3							
326	161	9,07	2210	1,35							
369	142	8,01	2170	1,45							
494	106	6	1990	1,5							
525	100	5,64 ⁽¹⁾	1970	1,55							
610	86	4,85	1910	1,75							
683	77	4,34	1860	1,9							
773	68	3,83	1810	2,1							

$P_1 = 7,5 \text{ kW}$											
24	2940	59,92	21500	1,1	iC 973 – HB3 132 M 4 B30G		194	205	210	221	148
27	2611	53,21	22100	1,2							
31	2334	47,58	21600	1,35							
34	2099	42,78	21200	1,5							
39	1821	37,13	20600	1,7							
44	1631	33,25	20100	1,8							
53	1353	27,58	19200	2,1							
46	1572	32,05	19900	1,85	iC 972 – HB3 132 M 4 B30G		190	201	206	217	148
54	1334	27,19	19200	2,2							
58	1228	25,03	18800	2,4							
65	1098	22,37	18300	2,6							
72	988	20,14	17800	2,8							
80	895	18,24	17300	3							
40	1807	36,84 ⁽¹⁾	14700	0,95	iC 873 – HB3 132 M 4 B25G		145	156	152	163	146
45	1602	32,66 ⁽¹⁾	15600	1,05							
52	1368	27,88	15200	1,2							
52	1366	27,84 ⁽¹⁾	15200	1,25	iC 872 – HB3 132 M 4 B25G		143	154	151	162	146
62	1148	23,4	14600	1,4							
68	1055	21,51	14400	1,45							
76	937	19,1	14000	1,55							
85	838	17,08 ⁽¹⁾	13700	1,7							
95	753	15,35	12600	1,8							
110	654	13,33	12900	2							
122	585	11,93	12500	2,1							
147	486	9,9 ⁽¹⁾	11900	2,4				135	146	143	154
160	449	9,14 ⁽¹⁾	11800	2,7							
178	403	8,22	11500	2,9							
205	350	7,13	11000	3,1							
229	313	6,39	10700	3,3							
275	260	5,3 ⁽¹⁾	10100	3,5							

⁽¹⁾ Finite transmission ratio i

$P_1 = 7,5 \text{ kW}$

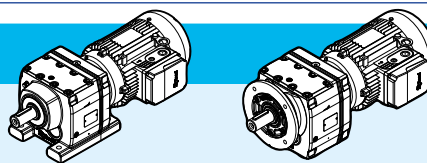







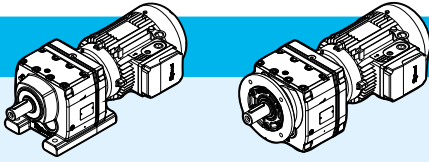

kg

p.

n_2 min ⁻¹	M_2 N m	i	F_{r2} N	fs		foot		flange					
						HB	HBZ	HB	HBZ				
78	922	18,8	5520	0,85	iC 772 – HB3 132 M 4 B20G		108	119	114	125	144		
82	874	17,82 ⁽¹⁾	5910	0,9									
94	765	15,6	6760	0,95									
104	689	14,05	7300	1,05									
118	605	12,33	7850	1,15									
134	534	10,88	7960	1,25									
151	473	9,64	7770	1,35					104	115	111	122	
170	422	8,59	7690	1,5									
189	380	7,74	7540	1,6									
215	333	6,79	7300	1,75									
244	294	5,99 ⁽¹⁾	7060	1,85									
275	261	5,31 ⁽¹⁾	6840	1,95									
115	623	12,7	4420	0,85	iC 672 – HB3 132 M 4 B16G		100	111	103	114	142		
127	566	11,54	5010	0,9									
146	490	10	5740	0,95									
168	427	8,7 ⁽¹⁾	5900	1,05									
187	382	7,79	5600	1					98	109	101	112	
198	361	7,36 ⁽¹⁾	5760	1,05									
233	307	6,27	5570	1,1									
256	279	5,7	5450	1,1									
296	242	4,93	5270	1,2									
340	211	4,29	5100	1,3									
183	391	7,97	1120	0,95			iC 572 – HB3 132 M 4 B16G		90	101	93	104	140
194	369	7,53	1410	0,95									
228	314	6,41	2120	1,05									
251	286	5,82	2470	1,15									
289	248	5,05	2750	1,25									
333	215	4,39	2700	1,3									
200	357	14,77 ⁽¹⁾	2620	1,2	iC 572 – HB3 132 SB 2 B16G		87	98	90	101	140		
212	338	13,95 ⁽¹⁾	2800	1,25									
249	287	11,88	2770	1,4									
274	261	10,79	2750	1,5									
317	226	9,35	2700	1,65									
371	193	7,97	2660	1,85					86	97	89	100	
393	182	7,53	2630	1,9									
462	155	6,41	2560	2,2									
508	141	5,82	2510	2,3									
587	122	5,05	2440	2,5									
674	106	4,39	2360	2,6									

⁽¹⁾ Finite transmission ratio i

$P_1 = 9,2 \text{ kW}$											
n_2 min ⁻¹	M_2 N m	i	F_{r2} N	fs		foot		flange			
						HB	HBZ	HB	HBZ		
27	3202	53,21	10800	1	iC 973 – HB3 132 MB 4 B30H		196	208	212	224	148
31	2863	47,58	20600	1,1							
34	2574	42,78	20200	1,25							
39	2234	37,13	19800	1,4							
44	2001	33,25	19300	1,5							
53	1660	27,58	18600	1,7							
58	1506	25,03	18200	1,95	iC 972 – HB3 132 MB 4 B30H		192	204	208	220	148
65	1346	22,37	17800	2,1							
72	1212	20,14	17300	2,3							
80	1098	18,24	16900	2,4							
90	973	16,17	16400	2,6							
100	880	14,62	16000	2,8							
118	746	12,39	15300	3,1							
68	1294	21,51	13800	1,2			iC 872 – HB3 132 MB 4 B25H		145	157	153
76	1149	19,1	13500	1,3							
85	1028	17,08 ⁽¹⁾	13200	1,4							
95	924	15,35	12900	1,5							
110	802	13,33	12500	1,65							
122	718	11,93	12200	1,75							
147	596	9,9 ⁽¹⁾	11600	2							
160	550	9,14 ⁽¹⁾	11600	2,2	138	150			146	158	
178	495	8,22	11300	2,4							
205	429	7,13	10900	2,5							
229	384	6,39	10500	2,7							
104	846	14,05	4880	0,85	iC 772 – HB3 132 MB 4 B20H		110	122	117	129	144
118	742	12,33	5730	0,95							
134	655	10,88	6380	1							
151	580	9,64	6880	1,1			107	119	113	125	
189	466	7,74	6370	1,3							
215	409	6,79	6770	1,45							
244	361	5,99 ⁽¹⁾	6890	1,5							
275	320	5,31 ⁽¹⁾	6690	1,6							

$P_1 = 11 \text{ kW}$											
34	3057	42,78	17800	1,05	iC 973 – HB3 160 M 4 B30H		144	-	160	-	148
40	2653	37,13	18900	1,15							
44	2376	33,25	18600	1,25							
53	1971	27,58	18000	1,4							
59	1789	25,03	17600	1,65	iC 972 – HB3 160 M 4 B30H		140	-	156	-	148
66	1599	22,37	17200	1,75							
73	1439	20,14	16900	1,9							
81	1303	18,24	16500	2							
91	1156	16,17	16000	2,2							

⁽¹⁾ Finite transmission ratio i

$P_1 = 11 \text{ kW}$

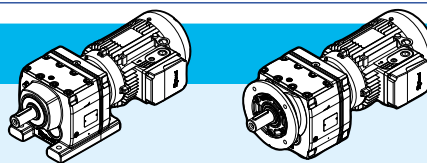









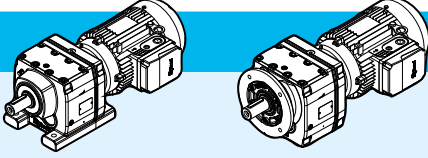



n_2 min ⁻¹	M_2 N m	i	F_{r2} N	fs		foot		flange		p.	
						HB	HBZ	HB	HBZ		
101	1045	14,62	15600	2,4	iC 972 – HB3 160 M 4 B30H		140	-	156	-	148
119	886	12,39	15000	2,6							
136	774	10,83	14500	2,9							
158	664	9,29	14200	3,3			128	-	144	-	
175	600	8,39	13800	3,5							
207	508	7,12	13100	3,9							
237	444	6,21	12600	4,3							
68	1537	21,51	13200	1	iC 872 – HB3 160 M 4 B25H		91	-	99	-	146
77	1365	19,1	13000	1,1							
86	1220	17,08 ⁽¹⁾	12700	1,15							
96	1097	15,35	12500	1,25							
110	952	13,33	12100	1,35							
123	853	11,93	11800	1,45							
148	707	9,9 ⁽¹⁾	11300	1,65							
161	653	9,14 ⁽¹⁾	11400	1,85			83	-	91	-	
179	587	8,22	11100	2							
206	510	7,13	10700	2,1							
230	457	6,39	10400	2,2							
277	379	5,3 ⁽¹⁾	9850	2,4							
135	777	10,88	4400	0,85	iC 772 – HB3 160 M 4 B20H		54	-	61	-	144
152	689	9,64	5130	0,9			51	-	58	-	
190	553	7,74	4740	1,1							
216	485	6,79	5340	1,2							
245	428	5,99 ⁽¹⁾	5800	1,25							
277	380	5,31 ⁽¹⁾	6140	1,35							

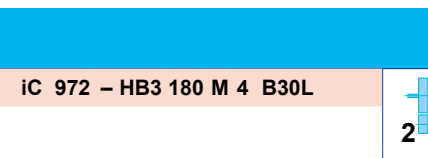

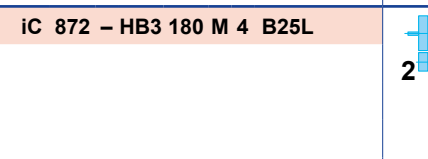

$P_1 = 15 \text{ kW}$

53	2688	27,58	16500	1,05	iC 973 – HB3 160 L 4 B30H		144	-	160	-	148
59	2439	25,03	16300	1,2							
66	2180	22,37	16100	1,3	iC 972 – HB3 160 L 4 B30H		140	-	156	-	148
73	1963	20,14	15800	1,4							
81	1777	18,24	15500	1,5							
91	1576	16,17	15200	1,6							
101	1425	14,62	14900	1,75							
119	1208	12,39	14400	1,95							
136	1055	10,83	13900	2,1							
158	905	9,29	13800	2,4			128	-	144	-	
175	818	8,39	13400	2,5							
207	693	7,12	12800	2,9							
237	606	6,21	12300	3,1							
86	1664	17,08 ⁽¹⁾	11600	0,85	iC 872 – HB3 160 L 4 B25H		91	-	99	-	146
96	1496	15,35	11500	0,9							

⁽¹⁾ Finite transmission ratio i

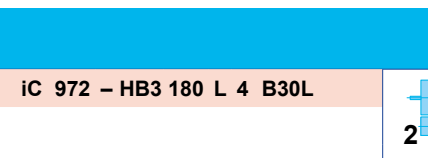
$P_1 = 15 \text{ kW}$											
n_2 min ⁻¹	M_2 N m	i	F_{r2} N	fs	iC 872 – HB3 160 L 4 B25H		foot		flange		
							HB	HBZ	HB	HBZ	
110	1299	13,33	11300	1			91	-	99	-	146
123	1163	11,93	11100	1,1							
148	965	9,9 ⁽¹⁾	10700	1,25							
161	891	9,14 ⁽¹⁾	10900	1,35			83	-	91	-	
179	801	8,22	10700	1,45							
206	695	7,13	10300	1,55							
230	623	6,39	10000	1,65							
277	516	5,3 ⁽¹⁾	9570	1,75							

$P_1 = 18,5 \text{ kW}$											
n_2 min ⁻¹	M_2 N m	i	F_{r2} N	fs	iC 972 – HB3 180 M 4 B30L		foot		flange		
							HB	HBZ	HB	HBZ	
73	2429	20,14	14900	1,1			140	-	156	-	148
80	2200	18,24	14700	1,2							
91	1951	16,17	14400	1,3							
100	1764	14,62	14200	1,4							
118	1495	12,39	13800	1,55							
135	1306	10,83	13400	1,7							
158	1120	9,29	13400	1,95			128	-	144	-	
175	1012	8,39	13100	2,1							
206	858	7,12	12500	2,4							
236	749	6,21	12100	2,5							
282	627	5,2	11500	2,9							
326	543	4,5 ⁽¹⁾	11100	3							
$P_1 = 18,5 \text{ kW}$											
n_2 min ⁻¹	M_2 N m	i	F_{r2} N	fs	iC 872 – HB3 180 M 4 B25L		foot		flange		
							HB	HBZ	HB	HBZ	
110	1607	13,33	10500	0,8			91	-	99	-	146
123	1439	11,93	10400	0,85							
148	1194	9,9 ⁽¹⁾	10200	1							
160	1103	9,14 ⁽¹⁾	10500	1,1			83	-	91	-	
178	991	8,22	10300	1,2							
205	860	7,13	10000	1,25							
229	770	6,39	9750	1,35							
276	639	5,3 ⁽¹⁾	9330	1,45							

$P_1 = 22 \text{ kW}$											
n_2 min ⁻¹	M_2 N m	i	F_{r2} N	fs	iC 972 – HB3 180 L 4 B30L		foot		flange		
							HB	HBZ	HB	HBZ	
73	2879	20,14	14000	0,95			140	-	156	-	148
81	2607	18,24	13900	1							
91	2312	16,17	13700	1,1							
101	2090	14,62	13500	1,2							
119	1772	12,39	13200	1,3							
136	1547	10,83	12900	1,45							
158	1327	9,29	13100	1,65			128	-	144	-	
175	1200	8,39	12800	1,75							
207	1017	7,12	12300	2							
237	888	6,21	11900	2,1							

⁽¹⁾ Finite transmission ratio i

$P_1 = 22 \text{ kW}$

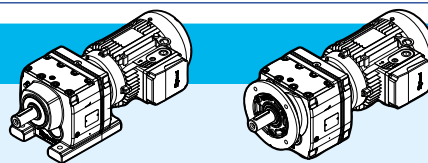

kg

p.

n_2 min ⁻¹	M_2 N m	i	F_{r2} N	fs		foot		flange			
						HB	HBZ	HB	HBZ		
283	743	5,2	11300	2,4	iC 972 – HB3 180 L 4 B30L		128	-	144	-	148
327	643	4,5 ⁽¹⁾	10900	2,5							
148	1415	9,9 ⁽¹⁾	9630	0,85	iC 872 – HB3 180 L 4 B25L		91	-	99	-	146
161	1307	9,14 ⁽¹⁾	10100	0,95							
179	1175	8,22	9940	1							
206	1020	7,13	9680	1,05							
230	913	6,39	9470	1,1							
277	758	5,3 ⁽¹⁾	9100	1,2							

$P_1 = 30 \text{ kW}$

101	2850	14,62	12000	0,85	iC 972 – HB3 200 L 4 B30M		146	-	162	-	148
119	2416	12,39	11900	0,95							
136	2110	10,83	11800	1,05							
158	1810	9,29	12300	1,2			134	-	150	-	
175	1636	8,39	12000	1,25							
207	1387	7,12	11700	1,45							
237	1211	6,21	11300	1,55							
283	1013	5,2	10900	1,75							
327	877	4,5 ⁽¹⁾	10500	1,85							

⁽¹⁾ Finite transmission ratio i

page intentionally left blank

Helical inline Dimensional drawings - iC

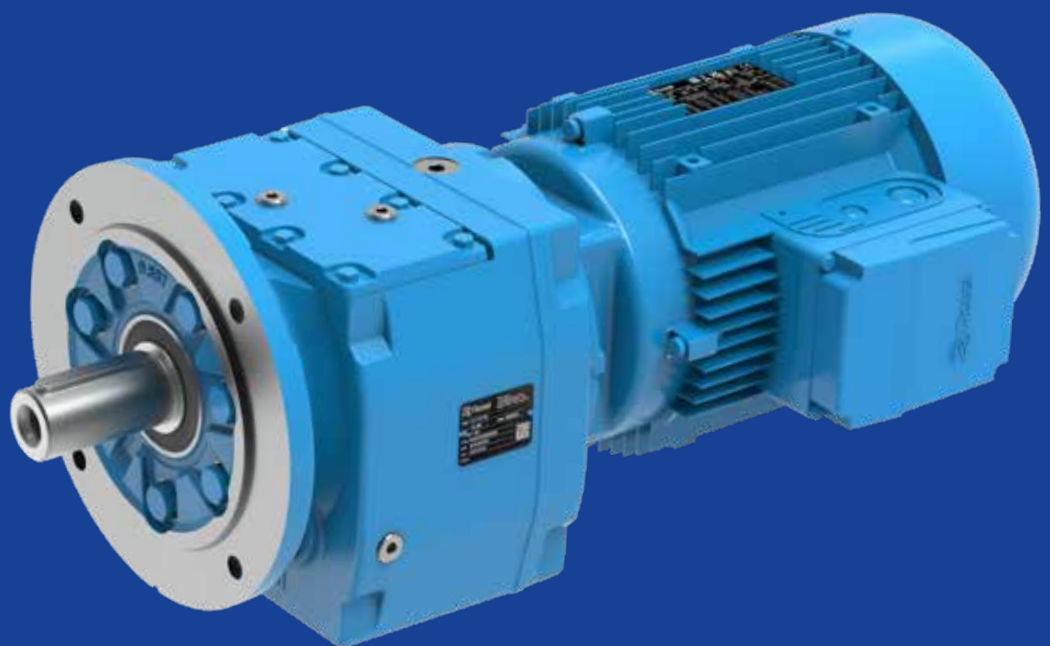

Section contents

10.1	iC 27...	134
10.2	iC 37...	136
10.3	iC 47...	138
10.4	iC 57...	140
10.5	iC 67...	142
10.6	iC 77..	144
10.7	iC 87...	146
10.8	iC 97...	148

10.1

iC 27...PE

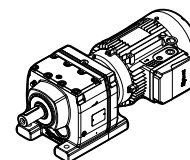

UTC 2400

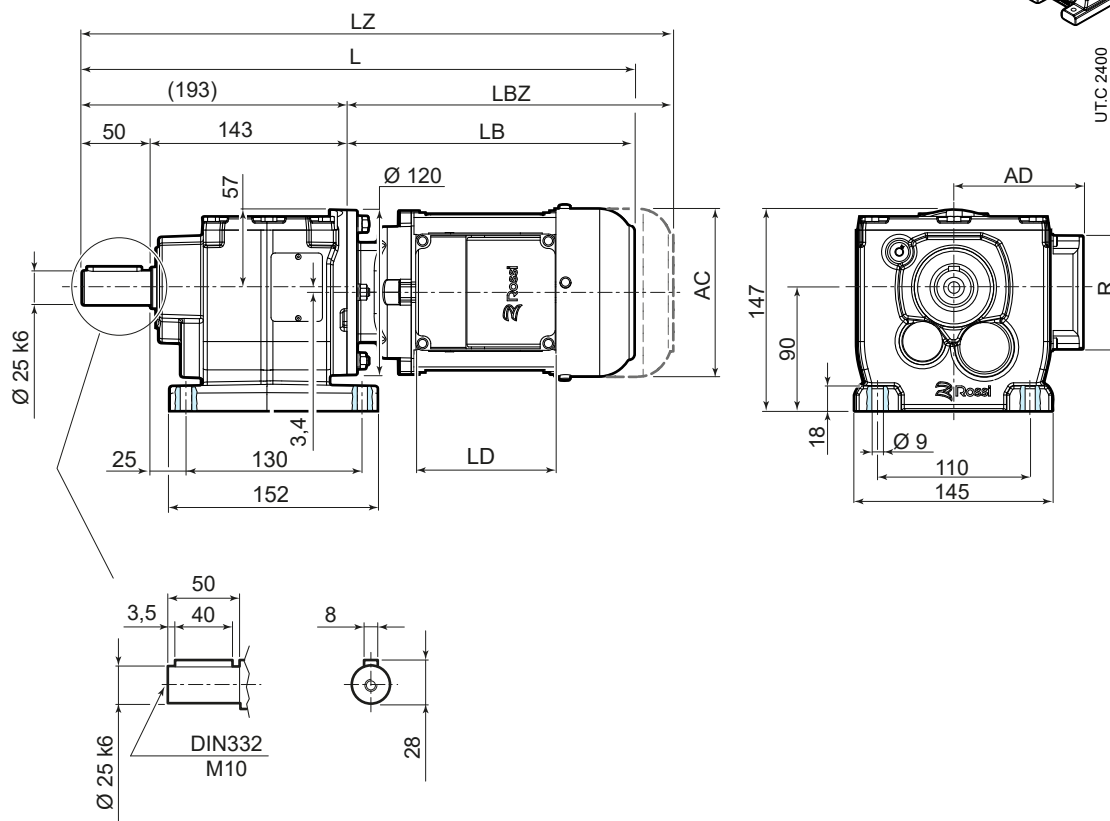

iC

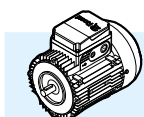
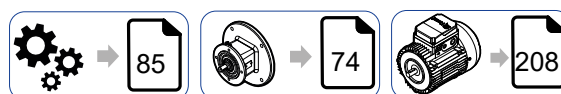

	63	71	80	90S ^{2) 3)}	90L ³⁾	100 ³⁾	112 ³⁾
AC	123	138	156	176	176	194	218
AD	95	112	121	141	141	151	163
LB	211	237	266	290	320	351	389
LBZ	266	299	335	369	399	446	488
L ¹⁾	404	430	459	483	513	544	582
LZ ¹⁾	459	492	528	562	592	639	681
LD	103	103	103	136	136	136	136
R	86	86	86	106	106	106	106

¹⁾ See also pages 80, 81

²⁾ For motors HB3-HB3Z 90S 2, HB3-HB3Z 90S 4 dimensions as motor size

³⁾ The motor protrudes the gear reducer foot mounting surface

iC 27...FE

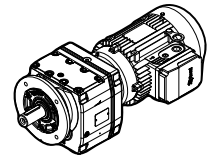

UTC 2401

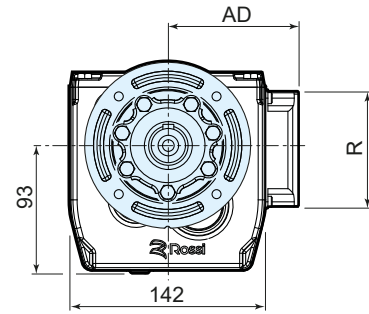
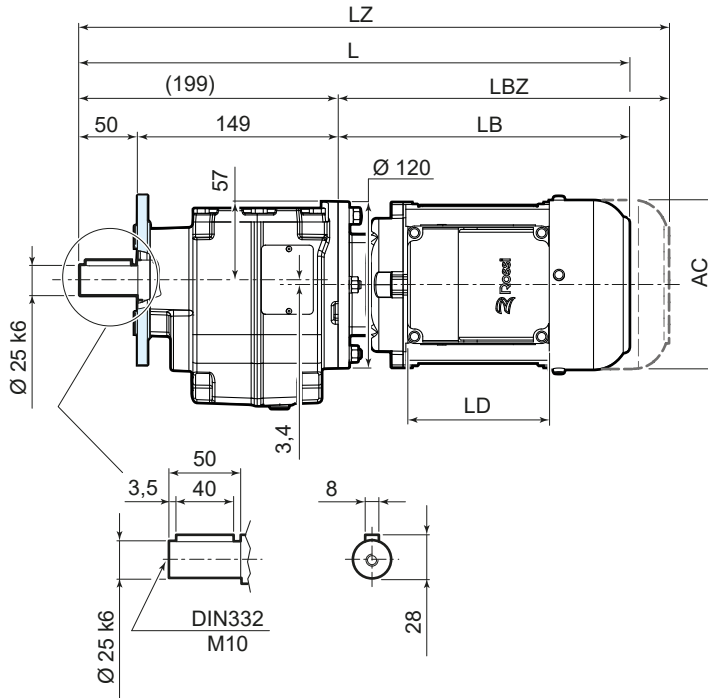

F212
Ø 120

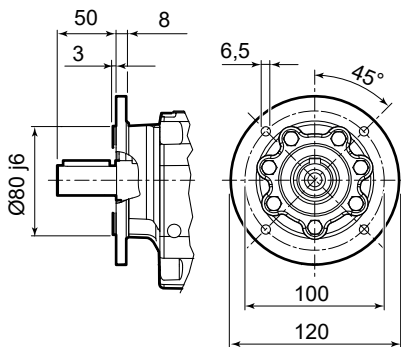

F214
Ø 140

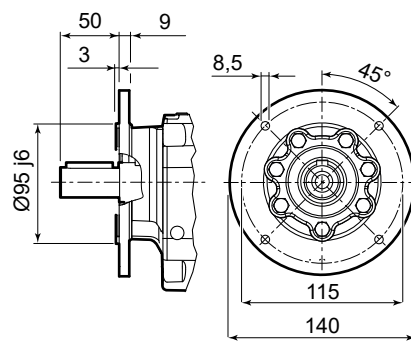

F216
Ø 160

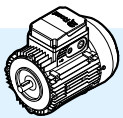
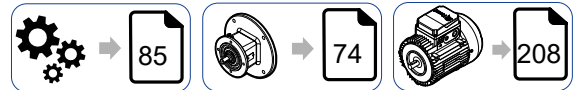
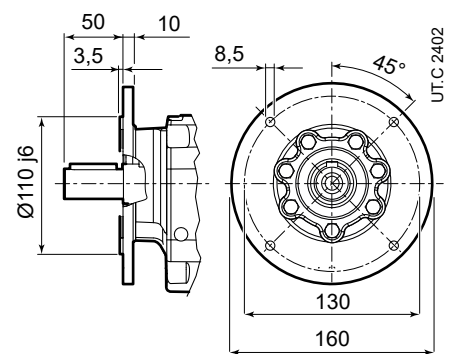

	63	71	80	90S ²⁾	90L	100	112
AC	123	138	156	176	176	194	218
AD	95	112	121	141	141	151	163
LB	211	237	266	290	320	351	389
LBZ	266	299	335	369	399	446	488
L ¹⁾	410	436	465	489	519	550	588
LZ ¹⁾	465	498	534	568	598	645	687
LD	103	103	103	136	136	136	136
R	86	86	86	106	106	106	106

¹⁾ See also pages 80, 81

²⁾ For motors HB3-HB3Z 90S 2, HB3-HB3Z 90S 4 dimensions as motor size

10.2

iC 37...PE

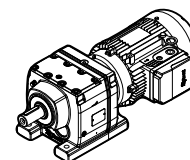

UTC 2403

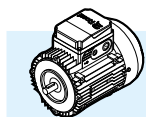
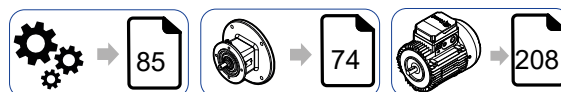
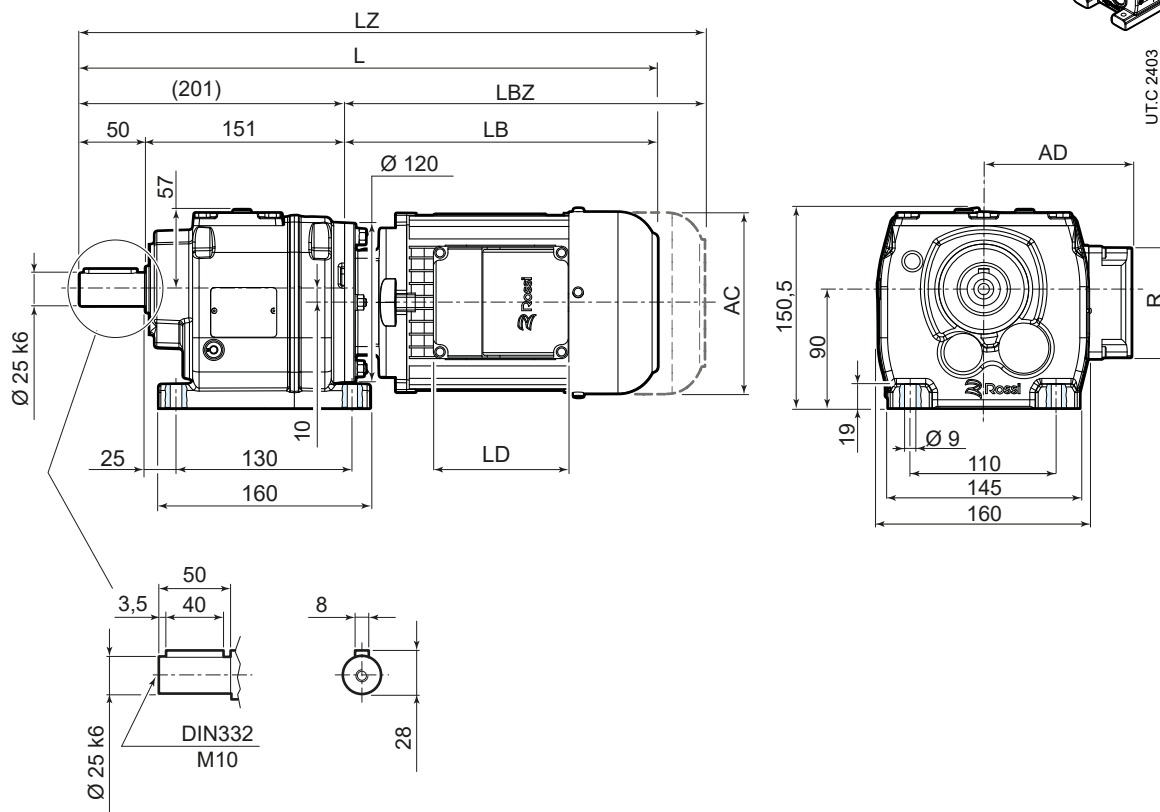

	63	71	80 ³⁾	90S ^{2) 3)}	90L ³⁾	100 ³⁾	112 ³⁾
AC	123	138	156	176	176	194	218
AD	95	112	121	141	141	151	163
LB	211	237	266	290	320	351	389
LBZ	266	299	335	369	399	446	488
L ¹⁾	412	438	467	491	521	552	590
LZ ¹⁾	467	500	536	570	600	647	689
LD	103	103	103	136	136	136	136
R	86	86	86	106	106	106	106

¹⁾ See also pages 80, 81

²⁾ For motors HB3-HB3Z 90S 2, HB3-HB3Z 90S 4 dimensions as motor size

³⁾ The motor protrudes the gear reducer foot mounting surface

iC 37...FE

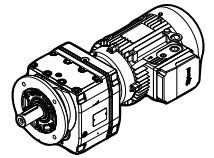

UTC 2404

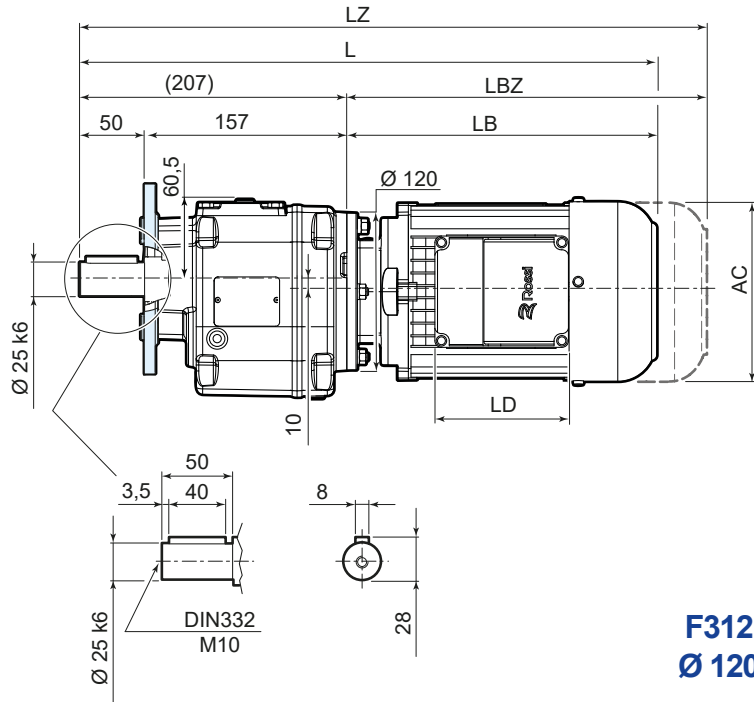

F312
Ø 120

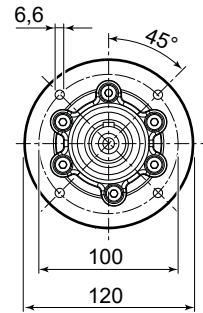
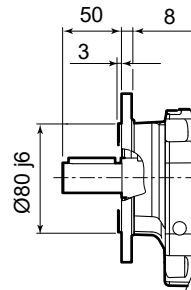
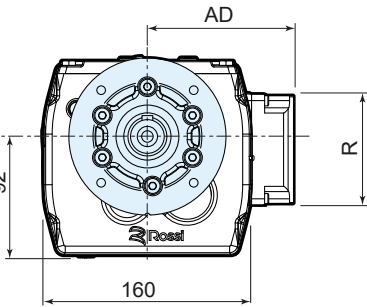

UTC 2405

iC

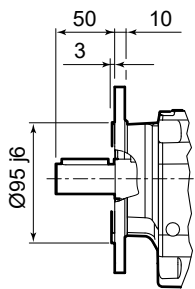

F314
Ø 140

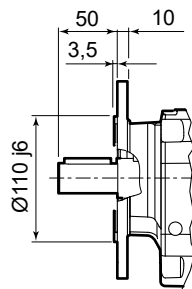
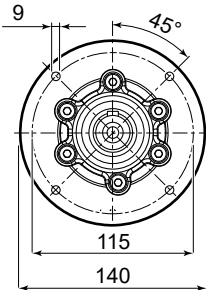

F316
Ø 160

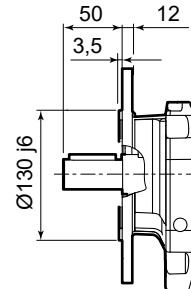
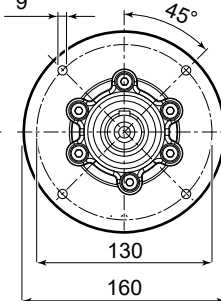

F320
Ø 200

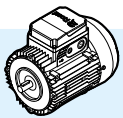
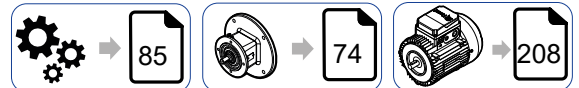
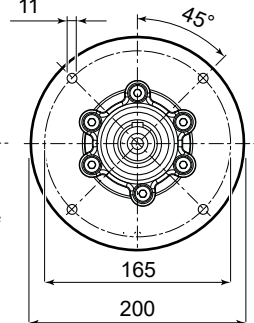

	63	71	80	90S ²⁾	90L	100	112
AC	123	138	156	176	176	194	218
AD	95	112	121	141	141	151	163
LB	211	237	266	290	320	351	389
LBZ	266	299	335	369	399	446	488
L ¹⁾	418	444	473	497	527	558	596
LZ ¹⁾	473	506	542	576	606	653	695
LD	103	103	103	136	136	136	136
R	86	86	86	106	106	106	106

¹⁾ See also pages 80, 81

²⁾ For motors HB3-HB3Z 90S 2, HB3-HB3Z 90S 4 dimensions as motor size

10.3

iC 47...PE

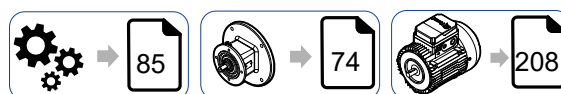
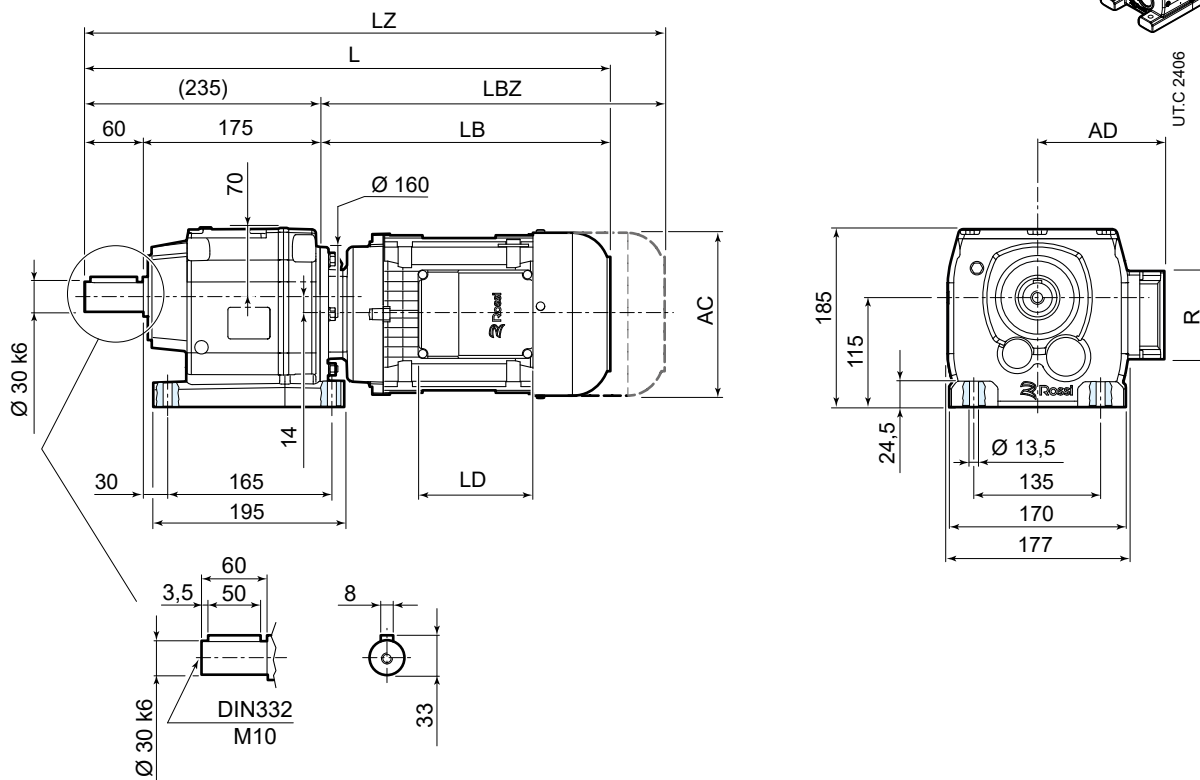
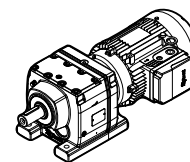

	63	71	80	90S ²⁾	90L	100 ⁴⁾	112 ⁴⁾	132S ^{3) 4)}	132M ⁴⁾
AC	123	138	156	176	176	194	218	257	257
AD	95	112	121	141	141	151	163	194	194
LB	205	231	260	283	313	345	383	439	499
LBZ	260	293	329	362	392	440	482	547	607
L ¹⁾	440	466	495	518	548	580	618	674	734
LZ ¹⁾	495	528	564	597	627	675	717	782	842
LD	103	103	103	136	136	136	136	190	190
R	86	86	86	106	106	106	106	148	148

¹⁾ See also pages 80, 81

²⁾ For motors HB3-HB3Z 90S 2, HB3-HB3Z 90S 4 dimensions as motor size

³⁾ For motors HB3-HB3Z 132 SB 2, HB3-HB3Z 132SC 2, HB3-HB3Z 132S 4 dimensions as motor size 132M

⁴⁾ The motor protrudes the gear reducer foot mounting surface

iC 47...FE

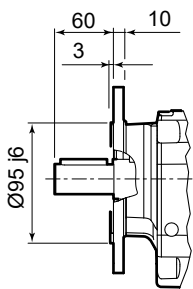
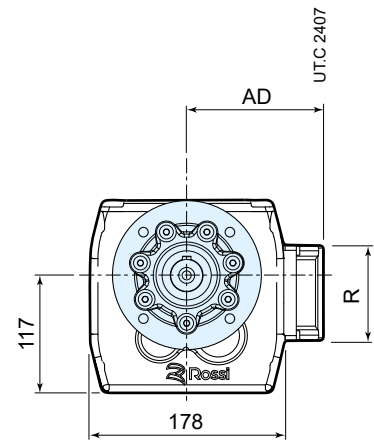
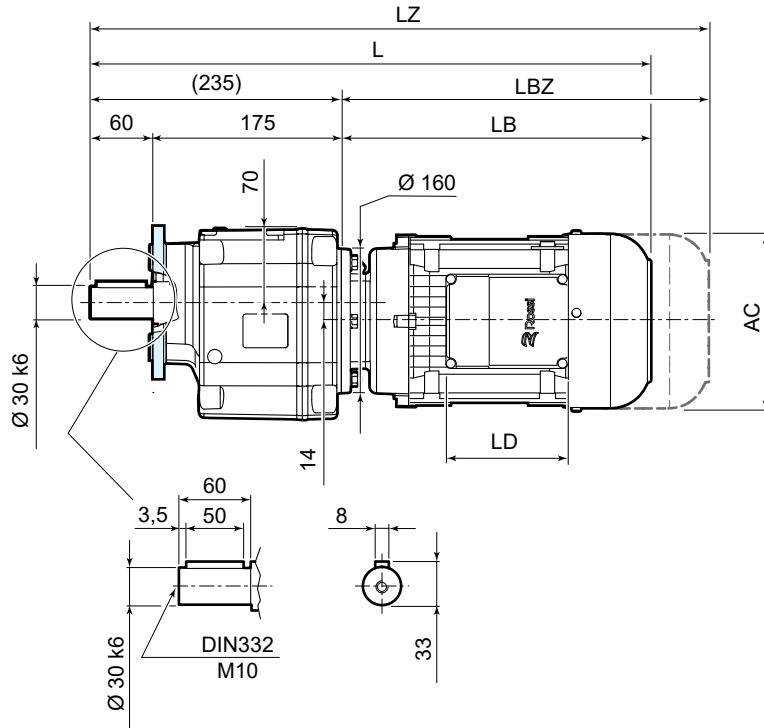
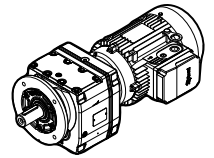

F414
Ø 140

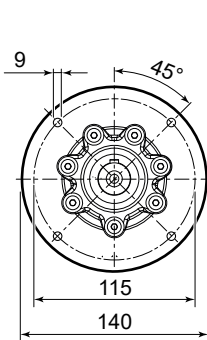

F416
Ø 160

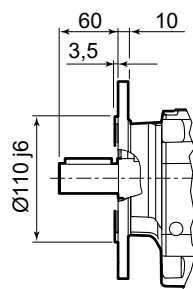

F420
Ø 200

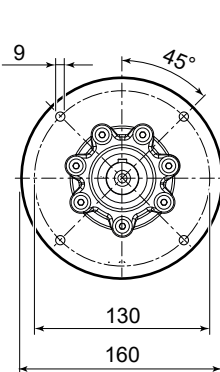

UTC 2408

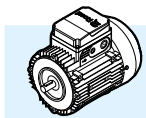
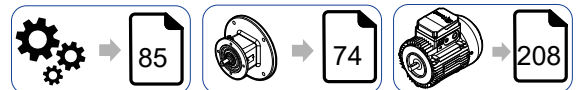

	63	71	80	90S ²⁾	90L	100	112	132S ³⁾	132M
AC	123	138	156	176	176	194	218	257	257
AD	95	112	121	141	141	151	163	194	194
LB	205	231	260	283	313	345	383	439	499
LBZ	260	293	329	362	392	440	482	547	607
L ¹⁾	440	466	495	518	548	580	618	674	734
LZ ¹⁾	495	528	564	597	627	675	717	782	842
LD	103	103	103	136	136	136	136	190	190
R	86	86	86	106	106	106	106	148	148

¹⁾ See also pages 80, 81

²⁾ For motors HB3-HB3Z 90S 2, HB3-HB3Z 90S 4 dimensions as motor size

³⁾ For motors HB3-HB3Z 132 SB 2, HB3-HB3Z 132SC 2, HB3-HB3Z 132S 4 dimensions as motor size 132M

10.4

iC 57...PE

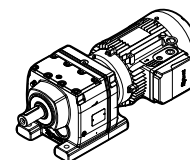

UTC 2409

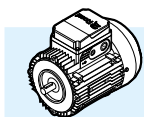
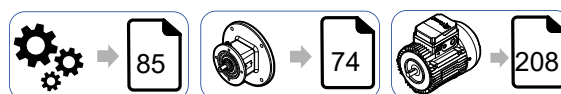
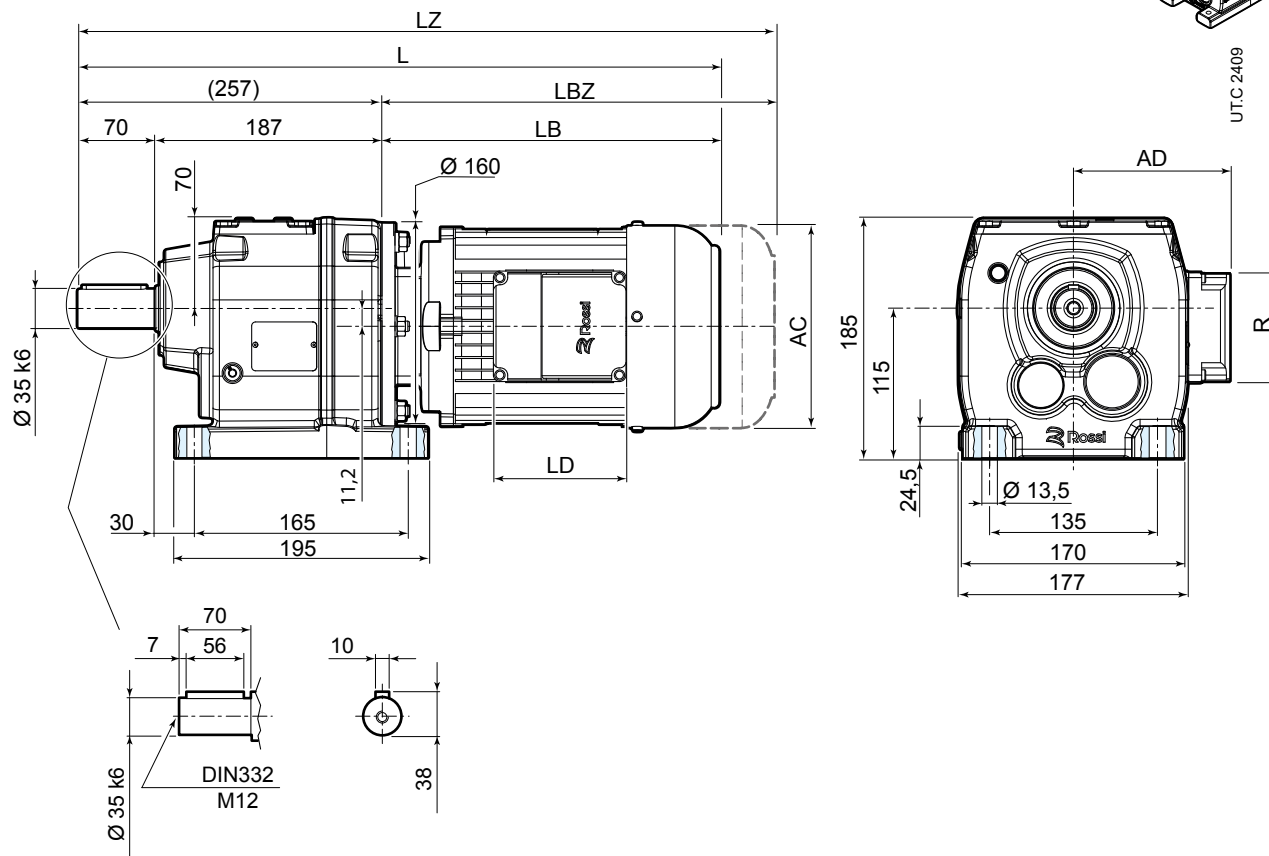

	63	71	80	90S ²⁾	90L	100	112 ⁴⁾	132S ³⁾⁴⁾	132M ⁴⁾
AC	123	138	156	176	176	194	218	257	257
AD	95	112	121	141	141	151	163	194	194
LB	205	231	260	283	313	345	383	439	499
LBZ	260	293	329	362	392	440	482	547	607
L ¹⁾	462	488	517	540	570	602	640	696	756
LZ ¹⁾	517	550	586	619	649	697	739	804	864
LD	103	103	103	136	136	136	136	190	190
R	86	86	86	106	106	106	106	148	148

¹⁾ See also pages 80, 81

²⁾ For motors HB3-HB3Z 90S 2, HB3-HB3Z 90S 4 dimensions as motor size

³⁾ For motors HB3-HB3Z 132 SB 2, HB3-HB3Z 132SC 2, HB3-HB3Z 132S 4 dimensions as motor size 132M

⁴⁾ The motor protrudes the gear reducer foot mounting surface

iC 57...FE

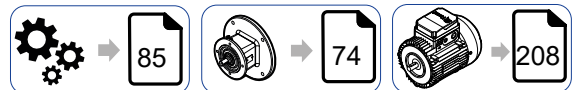
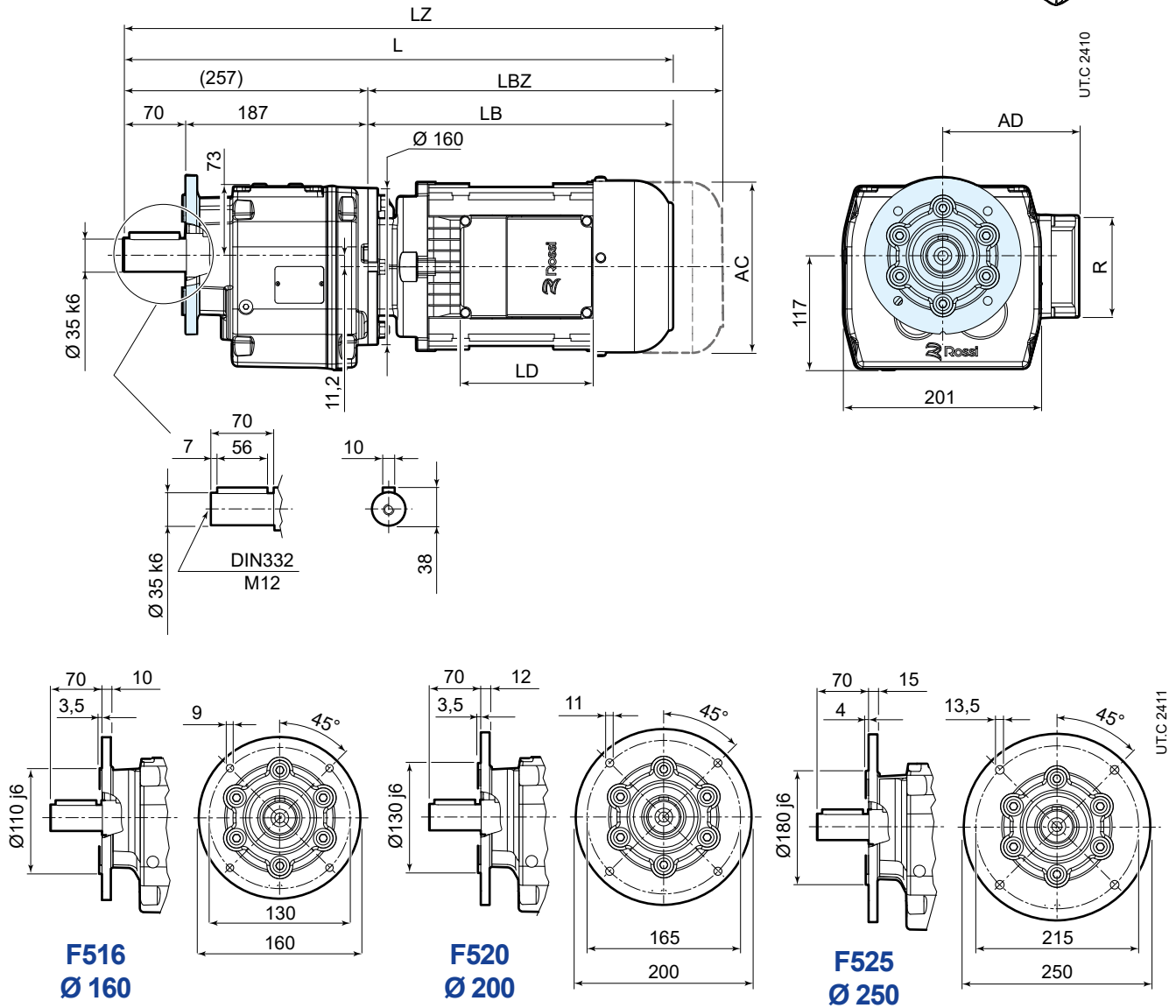
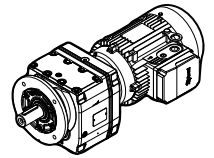

	63	71	80	90S ²⁾	90L	100	112	132S ³⁾	132M
AC	123	138	156	176	176	194	218	257	257
AD	95	112	121	141	141	151	163	194	194
LB	205	231	260	283	313	345	383	439	499
LBZ	260	293	329	362	392	440	482	547	607
L ¹⁾	462	488	517	540	570	602	640	696	756
LZ ¹⁾	517	550	586	619	649	697	739	804	864
LD	103	103	103	136	136	136	136	190	190
R	86	86	86	106	106	106	106	148	148

¹⁾ See also pages 80, 81

²⁾ For motors HB3-HB3Z 90S 2, HB3-HB3Z 90S 4 dimensions as motor size

³⁾ For motors HB3-HB3Z 132 SB 2, HB3-HB3Z 132SC 2, HB3-HB3Z 132S 4 dimensions as motor size 132M

iC 67...FE

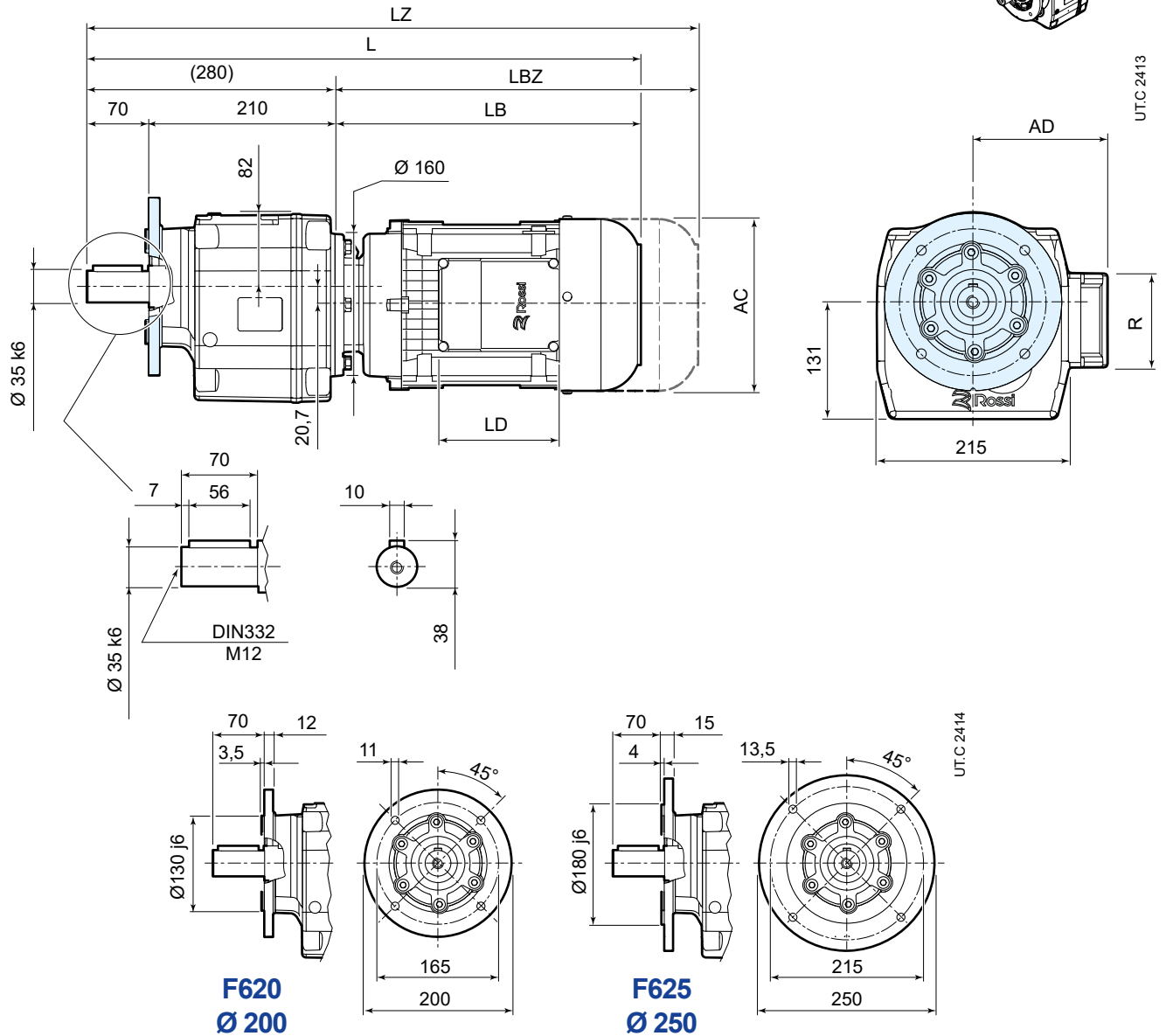
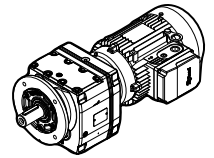

F620
Ø 200

F625
Ø 250

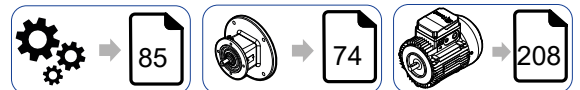

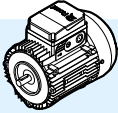
	63	71	80	90S ²⁾	90L	100	112	132S ³⁾	132M
AC	123	138	156	176	176	194	218	257	257
AD	95	112	121	141	141	151	163	194	194
LB	205	231	260	283	313	345	383	439	499
LBZ	260	293	329	362	392	440	482	547	607
L ¹⁾	485	511	540	563	593	625	663	719	779
LZ ¹⁾	540	573	609	642	672	720	762	827	887
LD	103	103	103	136	136	136	136	190	190
R	86	86	86	106	106	106	106	148	148

¹⁾ See also pages 80, 81

²⁾ For motors HB3-HB3Z 90S 2, HB3-HB3Z 90S 4 dimensions as motor size

³⁾ For motors HB3-HB3Z 132 SB 2, HB3-HB3Z 132SC 2, HB3-HB3Z 132S 4 dimensions as motor size 132M

10.6

iC 77...PE

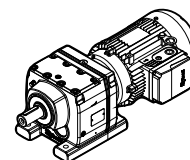

UTC 2415

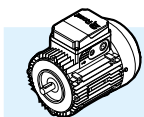
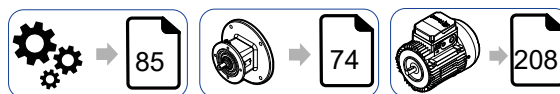
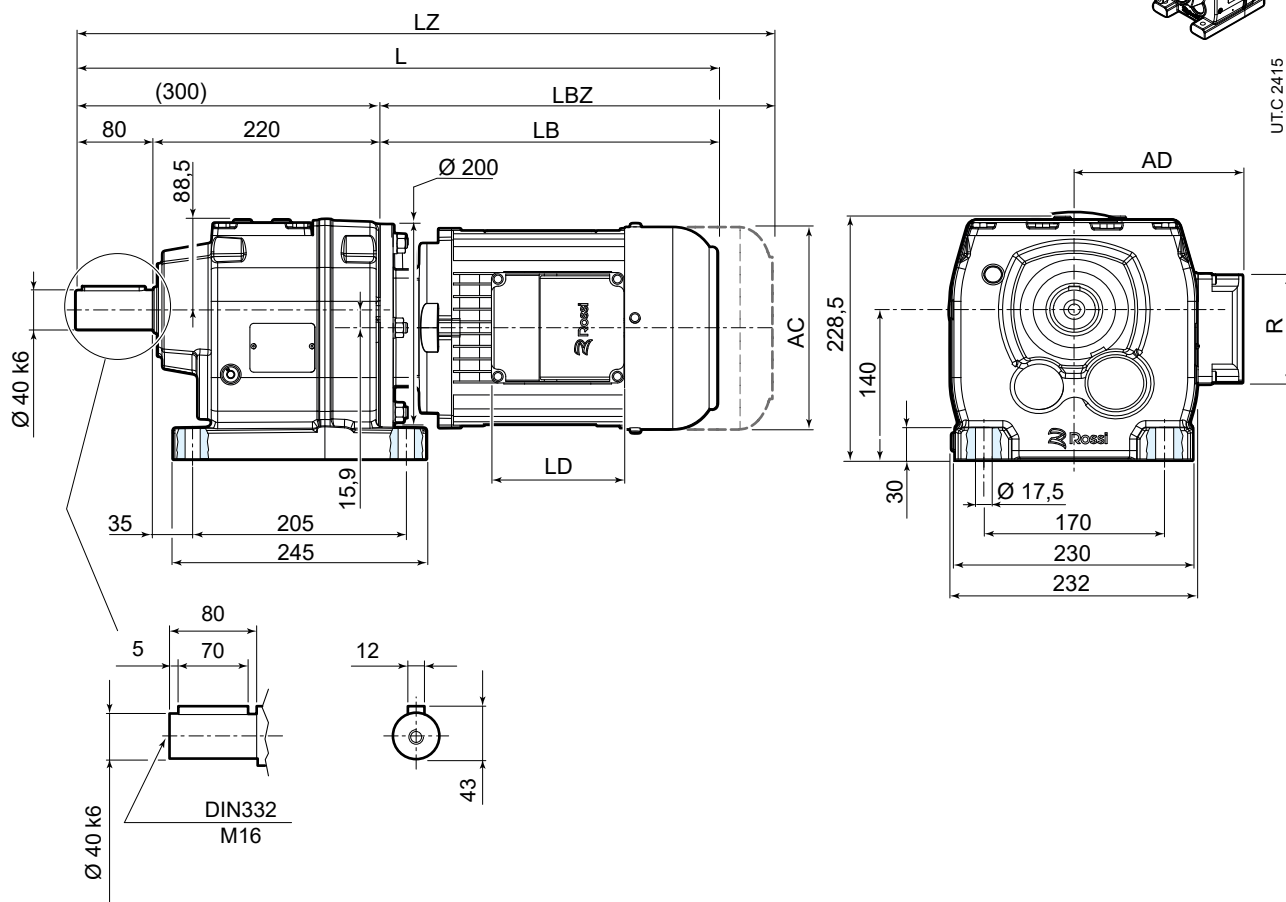

	63	71	80	90S ²⁾	90L	100	112	132S ^{3) 4)}	132M ⁴⁾
AC	123	138	156	176	176	194	218	257	257
AD	95	112	121	141	141	151	163	194	194
LB	199	225	254	276	306	339	377	433	493
LBZ	254	287	323	355	385	434	476	541	601
L ¹⁾	499	525	554	576	606	639	677	733	793
LZ ¹⁾	554	587	623	655	685	734	776	841	901
LD	103	103	103	136	136	136	136	190	190
R	86	86	86	106	106	106	106	148	148

¹⁾ See also pages 80, 81

²⁾ For motors HB3-HB3Z 90S 2, HB3-HB3Z 90S 4 dimensions as motor size

³⁾ For motors HB3-HB3Z 132 SB 2, HB3-HB3Z 132SC 2, HB3-HB3Z 132S 4 dimensions as motor size 132M

⁴⁾ The motor protrudes the gear reducer foot mounting surface

10.7

iC 87...PE

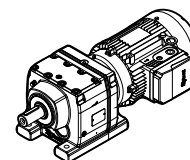

UTC 2418

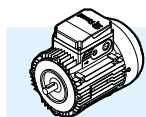
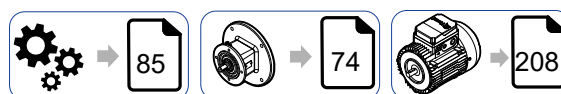
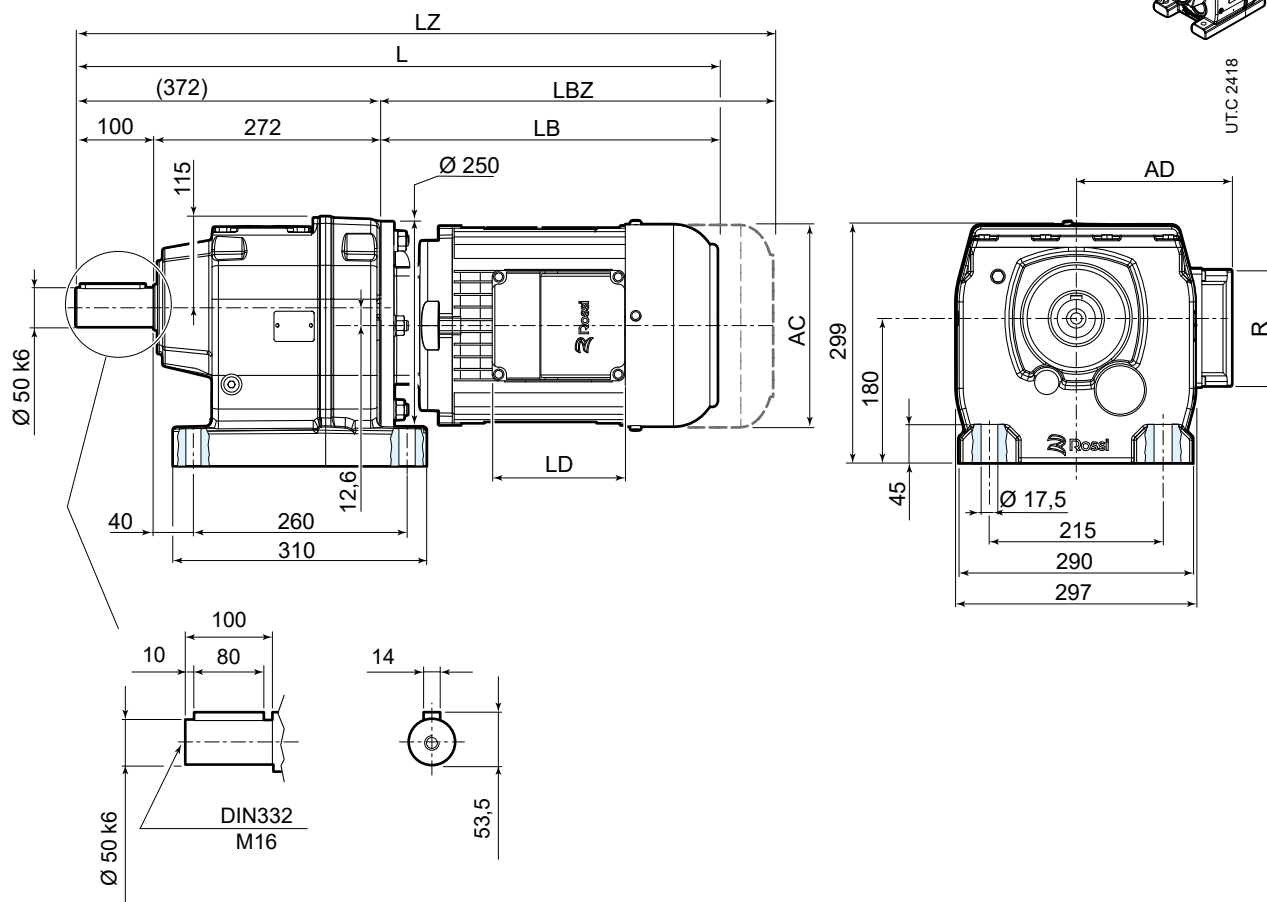

	80	90S ²⁾	90L	100	112	132S ³⁾	132M
AC	156	176	176	194	218	257	257
AD	121	141	141	151	163	194	194
LB	249	272	302	334	372	428	488
LBZ	318	351	381	429	471	536	596
L ¹⁾	621	644	674	706	744	800	860
LZ ¹⁾	690	723	753	801	843	908	968
LD	103	136	136	136	136	190	190
R	86	106	106	106	106	148	148

¹⁾ See also pages 80, 81

²⁾ For motors HB3-HB3Z 90S 2, HB3-HB3Z 90S 4 dimensions as motor size

³⁾ For motors HB3-HB3Z 132 SB 2, HB3-HB3Z 132SC 2, HB3-HB3Z 132S 4 dimensions as motor size 132M

10.8

iC 97...PE

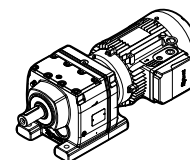

UTC 2421

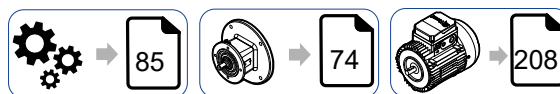
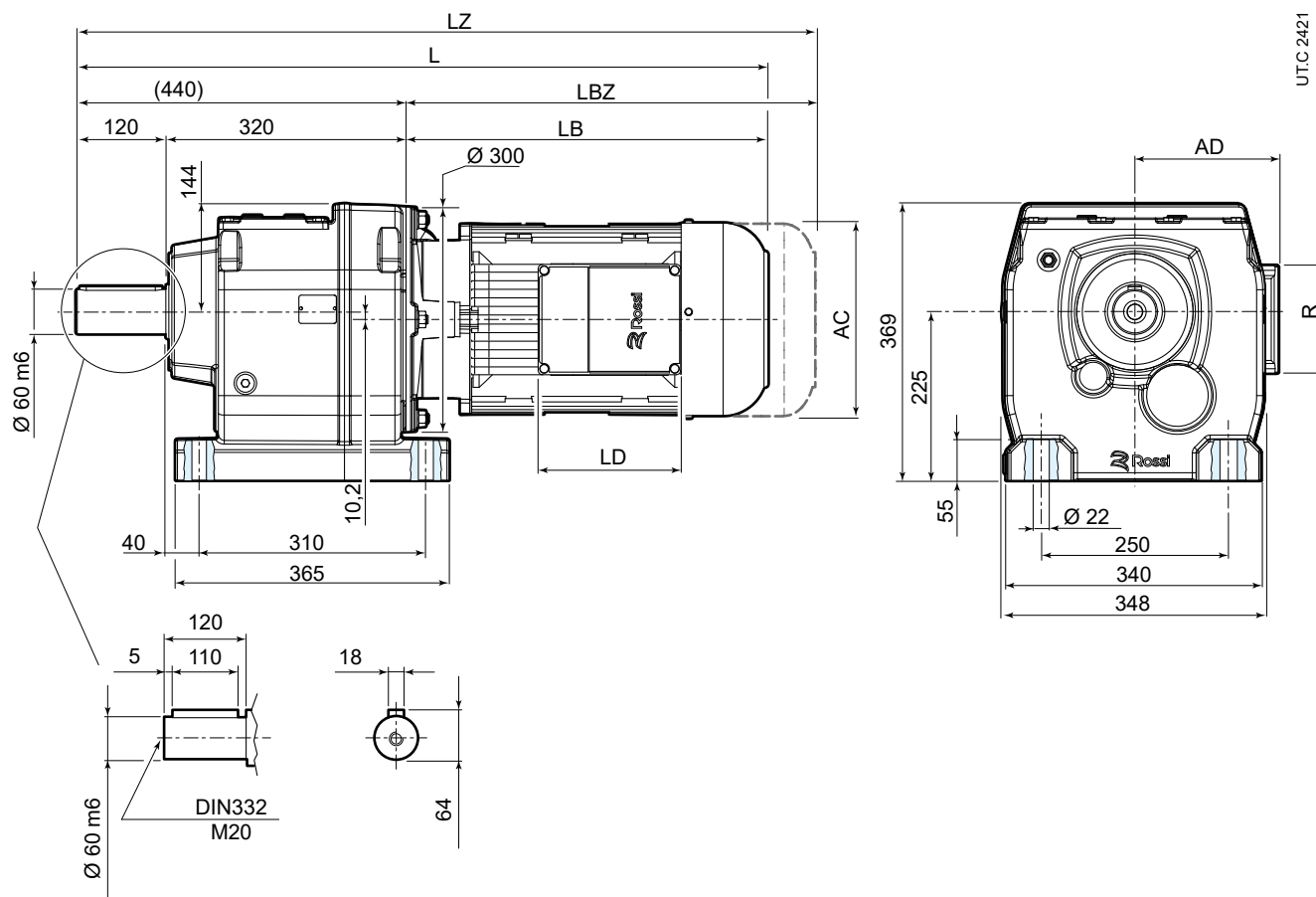

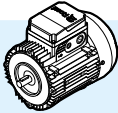
	80	90S ²⁾	90L	100	112	132S ³⁾	132M
AC	156	176	176	194	218	257	257
AD	121	141	141	151	163	194	194
LB	242	264	294	327	364	423	483
LBZ	311	343	373	422	463	531	591
L ¹⁾	682	704	734	767	804	863	923
LZ ¹⁾	751	783	813	862	903	971	1031
LD	103	136	136	136	136	190	190
R	86	106	106	106	106	148	148

¹⁾ See also pages 80, 81

²⁾ For motors HB3-HB3Z 90S 2, HB3-HB3Z 90S 4 dimensions as motor size

³⁾ For motors HB3-HB3Z 132 SB 2, HB3-HB3Z 132SC 2, HB3-HB3Z 132S 4 dimensions as motor size 132M

iC 97...FE

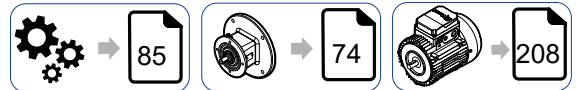
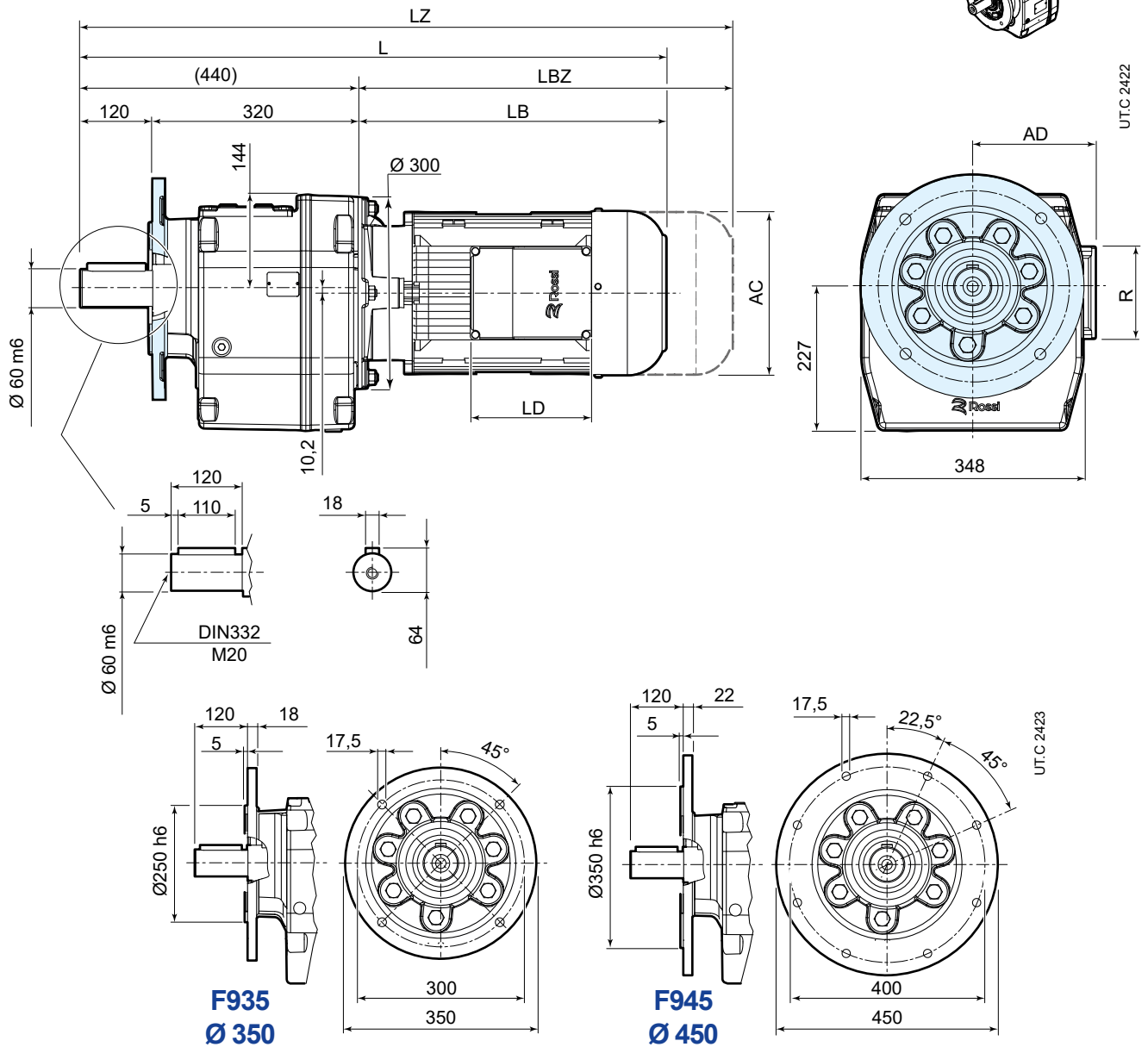
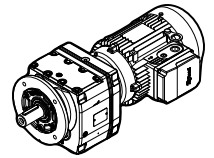

	80	90S ²⁾	90L	100	112	132S ³⁾	132M
AC	156	176	176	194	218	257	257
AD	121	141	141	151	163	194	194
LB	242	264	294	327	364	423	483
LBZ	311	343	373	422	463	531	591
L ¹⁾	682	704	734	767	804	863	923
LZ ¹⁾	751	783	813	862	903	971	1031
LD	103	136	136	136	136	190	190
R	86	106	106	106	106	148	148

¹⁾ See also pages 80, 81

²⁾ For motors HB3-HB3Z 90S 2, HB3-HB3Z 90S 4 dimensions as motor size

³⁾ For motors HB3-HB3Z 132 SB 2, HB3-HB3Z 132SC 2, HB3-HB3Z 132S 4 dimensions as motor size 132M

Bevel helical Selection tables - iO

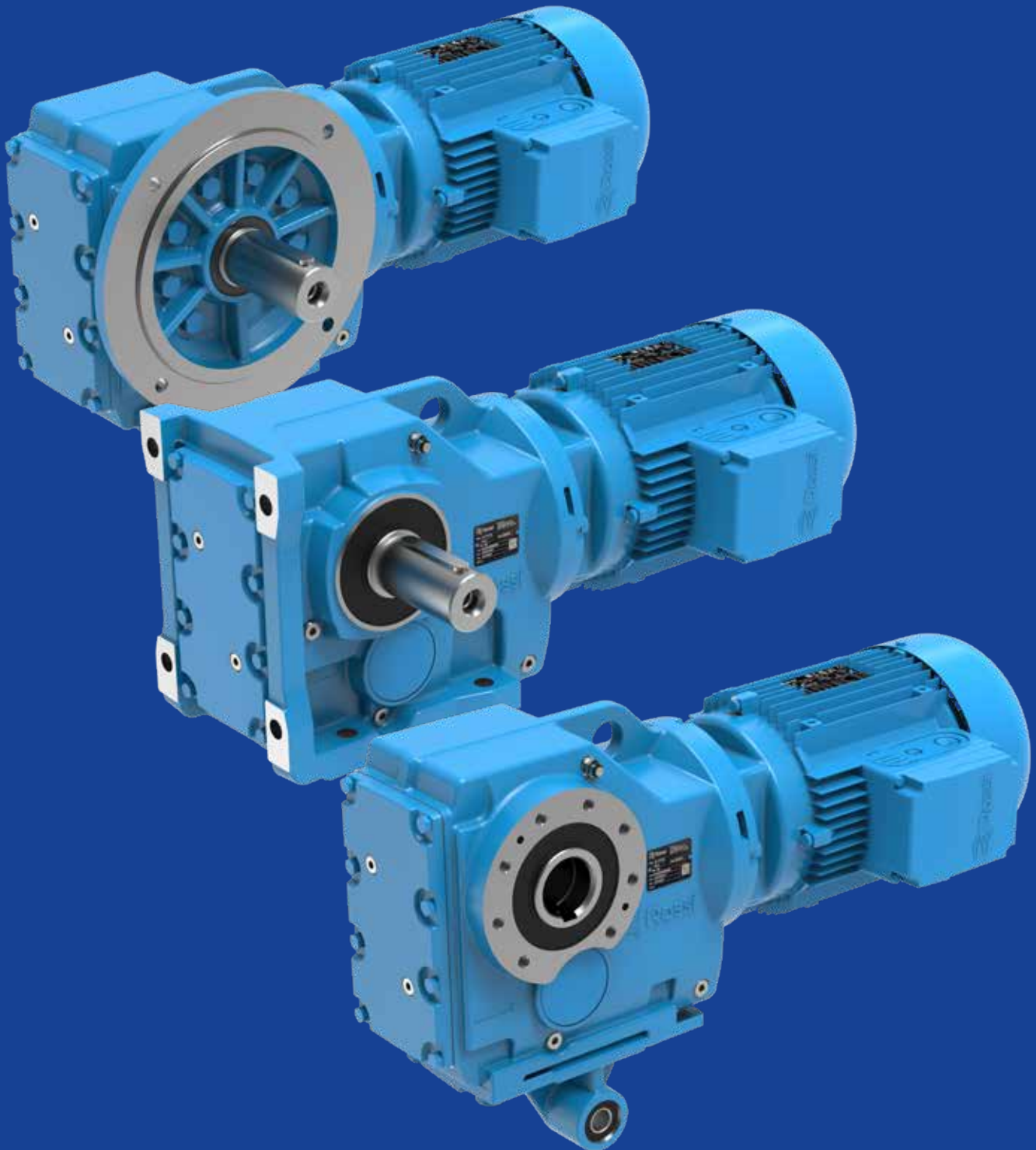

Section contents

11.1	Possible geometrical combinations	152
11.1.1	General	152
11.1.2	Key	152
11.2	Geometrical coupling tables	153
11.3	Selection tables [kW]	160

Geometrical coupling tables

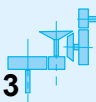
Gear reducer						Motor size									
$M_{N2max} = 224 \text{ N m}$ $n_1 = 1400 \text{ min}^{-1}$															
iO 373						63A 63B 71A 71B	80A 80B	90S 90L	100LA 112MA	112M	132S 132M	132MB	160M 160L	180M 180L	200L
	n_2 min ⁻¹	M_{N2} N m	F_{r2} N	φ arc min	i										
iO 373 	13	224	5640	7	106,38										
	14	224	5640	7	97,81										
	17	224	5640	7	83,69										
	19	224	5520	7	72,54										
	21	224	5360	7	67,8										
	24	224	5020	7	58,6										
	28	224	4660	7	49,79										
	31	224	4420	7	44,46										
	37	224	4100	7	37,97										
	39	224	3970	8	35,57										
	47	224	3650	8	29,96										
	49	224	3580	9	28,83										
	56	224	3330	9	24,99										
	60	315	3260	9	23,36										
	69	205	3110	9	20,19										
	82	200	2900	9	17,15										
	91	195	2780	9	15,31										
	107	185	2650	9	13,08										
	115	180	2600	12	12,14										
	133	180	2410	13	10,49										
157	180	2200	13	8,91											
176	175	2110	13	7,96											
206	170	1980	13	6,8											
220	160	1950	13	6,37											
261	150	1810	14	5,36											

Gear reducer						Motor size									
$M_{N2max} = 450 \text{ N m}$ $n_1 = 1400 \text{ min}^{-1}$															
iO 473						63A 63B 71A 71B	80A 80B	90S 90L	100LA 112MA	112M	132S 132M	132MB	160M 160L	180M 180L	200L
	n_2 min ⁻¹	M_{N2} N m	F_{r2} N	φ arc min	i										
iO 473 	11	450	5920	7	131,87 ⁽¹⁾										
	12	450	5920	7	121,48 ⁽¹⁾										
	13	450	5920	7	104,37										
	15	450	5920	7	90,86										
	16	450	5920	7	85,12 ⁽¹⁾										
	19	450	5920	7	75,2 ⁽¹⁾										
	20	450	5920	7	69,84										
	22	450	5920	7	63,3 ⁽¹⁾										
	25	450	5920	7	56,83										
	29	450	5920	7	48,95 ⁽¹⁾										
	30	450	5920	7	46,03 ⁽¹⁾										
	35	450	5920	7	39,61										
	40	450	5920	7	35,39										
	45	450	5700	8	31,3										
	48	450	5520	8	29,32										
	54	450	5170	8	25,91										
	58	450	4970	8	24,06										
	64	450	4710	8	21,81										
	72	450	4440	8	19,58										
	83	425	4220	8	16,86										
	88	425	4080	8	15,86										
	103	400	3890	8	13,65										
	115	385	3720	9	12,19										
	119	280	4060	11	11,77										
133	280	3830	11	10,56											
154	280	3540	11	9,1											
164	270	3500	11	8,56											
190	250	3380	11	7,36											
213	240	3270	12	6,58											
241	230	3140	12	5,81											

⁽¹⁾ Finite transmission ratio i

Gear reducer						Motor size									
$M_{N2max} = 670 \text{ N m}$ $n_1 = 1400 \text{ min}^{-1}$															
iO 573						63A 63B 71A 71B	80A 80B	90S 90L	100LA 112MA	112M	132S 132M	132MB	160M 160L	180M 180L	200L
	n_2 min ⁻¹	M_{N2} N m	F_{r2} N	φ arc min	i										
iO 573  3	9,6	670	7630	6	145,14 ⁽¹⁾										
	11	670	7630	6	123,85										
	13	670	7630	6	108,29										
	14	670	7630	6	102,88 ⁽¹⁾										
	16	670	7630	6	90,26 ⁽¹⁾										
	18	670	7630	6	76,56 ⁽¹⁾										
	20	670	7630	6	69,12										
	23	670	7630	6	60,81 ⁽¹⁾										
	24	670	7630	6	57,42 ⁽¹⁾										
	29	670	7630	6	48,89										
	32	670	7630	7	44,43										
	36	670	7630	7	38,49										
	39	670	7630	7	35,7										
	46	670	7300	7	30,28										
	51	670	6930	7	27,34										
	58	670	6480	7	24,05										
	62	670	6280	7	22,71										
	72	650	5910	7	19,34										
	80	615	5740	8	17,57										
	92	600	5430	8	15,22										
106	580	5190	8	13,25											
117	460	5150	10	11,92											
124	460	4990	10	11,26											
146	450	4650	10	9,59											
161	430	4520	10	8,71											
185	400	4360	11	7,55											
213	375	4180	11	6,57											

⁽¹⁾ Finite transmission ratio i

Gear reducer						Motor size									
$M_{N2max} = 925 \text{ N m}$ $n_1 = 1400 \text{ min}^{-1}$															
iO 673						63A 63B 71A 71B	80A 80B	90S 90L	100LA 112MA	112M	132S 132M	132MB	160M 160L	180M 180L	200L
	n_2 min ⁻¹	M_{N2} N m	F_{r2} N	φ arc min	i										
iO 673  3	9,7	925	10300	7	144,79 ⁽¹⁾										
	11	915	10300	7	123,54										
	13	910	10300	7	108,03										
	14	910	10300	7	102,62										
	16	905	10300	7	90,04										
	18	900	10300	7	76,37										
	20	900	10300	7	68,95										
	23	895	10300	7	60,66										
	24	895	10300	7	57,28										
	29	890	10300	7	48,77										
	32	885	10300	7	44,32										
	36	880	10500	7	38,39										
	39	880	10300	8	35,62										
	46	875	10300	8	30,22										
	51	875	10300	8	27,28										
	58	870	10500	8	24										
	62	870	10700	8	22,66										
	73	850	10800	8	19,3										
	80	820	11000	8	17,54										
	92	765	11300	8	15,19										
106	670	11500	8	13,22											
112	530	12300	9	12,48											
132	500	11800	9	10,63											
145	480	11500	10	9,66											
167	440	11100	10	8,37											
192	420	10700	10	7,28											

iO

Gear reducer						Motor size									
$M_{N2max} = 1750 \text{ N m}$ $n_1 = 1400 \text{ min}^{-1}$															
iO 773						63A 63B 71A 71B	80A 80B	90S 90L	100LA 112MA	112M	132S 132M	132MB	160M 160L	180M 180L	200L
	n_2 min ⁻¹	M_{N2} N m	F_{r2} N	φ arc min	i										
iO 773 	7,3	1600	16100	6	192,18										
	7,8	1600	16100	6	179,37										
	9,1	1750	15400	6	154,02										
	10	1750	15400	6	135,28										
	11	1750	15400	6	128,52										
	12	1750	15400	6	113,56										
	14	1750	15400	6	97,05										
	16	1750	15400	6	88,97										
	18	1750	15400	6	78,07										
	19	1750	15400	6	73,99										
	22	1750	15400	6	64,75										
	24	1750	15400	6	58,34										
	27	1750	15400	6	51,18										
	31	1750	15400	6	45,16										
	35	1750	15400	6	40,04										
	36	1700	15700	6	38,39										
	40	1750	15400	6	35,2										
	45	1750	15400	7	30,89										
	48	1750	15400	7	29,27										
	55	1750	15400	7	25,62										
	61	1750	15400	7	23,08										
	69	1700	15700	7	20,25										
	78	1600	16100	7	17,87										
88	1550	15500	7	15,84											
104	1500	14800	7	13,52											
113	1045	15100	8	12,36											
129	990	14400	8	10,84											
146	940	13900	8	9,56											
165	890	13500	9	8,48											
193	820	13100	9	7,24											

iO

Gear reducer						Motor size									
$M_{N2max} = 3000 \text{ N m}$ $n_1 = 1400 \text{ min}^{-1}$															
iO 873						63A 63B 71A 71B	80A 80B	90S 90L	100LA 112MA	112M	132S 132M	132MB	160M 160L	180M 180L	200L
	n_2 min ⁻¹	M_{N2} N m	F_{r2} N	φ arc min	i										
iO 873 	7,1	3000	27300	6	197,37										
	8	3000	27300	6	174,19										
	8,5	3000	27300	6	164,34 ⁽¹⁾										
	9,5	3000	27300	6	147,32 ⁽¹⁾										
	11	3000	27300	6	126,91 ⁽¹⁾										
	12	3000	27300	6	115,82										
	14	3000	27300	6	102,71 ⁽¹⁾										
	16	3000	27300	6	86,34										
	18	3000	27300	6	79,34										
	20	3000	27300	6	70,46										
	22	3000	26200	6	63 ⁽¹⁾										
	25	3000	25000	6	56,64										
	28	3000	23500	6	49,16										
	32	2900	22800	6	44,02										
	38	2800	21400	6	36,52 ⁽¹⁾										
	45	3000	19200	7	31,39										
	50	2900	18500	7	27,88										
	56	2800	18000	7	24,92										
	62	2570	17900	7	22,41										
	72	2570	16800	7	19,45										
80	2430	16300	7	17,42											
88	1970	16000	7	16											
97	2360	15300	7	14,45											
111	2240	14800	7	12,56											
125	1700	14900	7	11,17											
140	1700	14200	7	10											
169	1550	13500	7	8,29											
194	1450	13200	8	7,21											









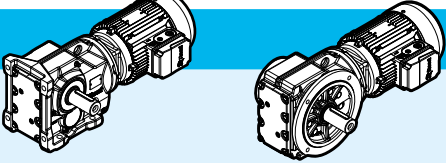

⁽¹⁾ Finite transmission ratio i



Gear reducer						Motor size									
$M_{N2max} = 4870 \text{ N m}$ $n_1 = 1400 \text{ min}^{-1}$															
iO 973						63A 63B 71A 71B	80A 80B	90S 90L	100LA 112MA	112M	132S 132M	132MB	160M 160L	180M 180L	200L
	n_2 min ⁻¹	M_{N2} N m	F_{r2} N	φ arc min	i										
iO 973  3	8	4870	40000	7	176,05 ⁽¹⁾										
	9,1	4870	40000	7	153,21 ⁽¹⁾										
	10	4870	40000	7	140,28										
	11	4870	40000	7	123,93 ⁽¹⁾										
	13	4870	40000	7	105,13										
	14	4870	40000	7	96,8										
	16	4870	38800	7	86,52										
	18	4870	37100	7	77,89 ⁽¹⁾										
	20	4870	35600	7	70,54										
	22	4870	33800	7	62,55										
	25	4870	32300	7	56,55										
	29	4870	30000	7	47,93 ⁽¹⁾										
	33	4870	28300	7	41,87										
	37	4870	27100	8	38,3										
	41	4870	25700	8	34,23										
	45	4870	24500	8	30,82										
	50	4870	23300	8	27,91										
	57	4870	22000	8	24,75										
	63	4870	20900	8	22,37										
	74	4870	19100	8	18,96										
85	4870	17800	8	16,56											
101	4580	16100	8	13,85											
117	4270	16200	8	11,99											
134	3130	16400	10	10,41											
161	2880	15800	10	8,71											

⁽¹⁾ Finite transmission ratio i









11.3

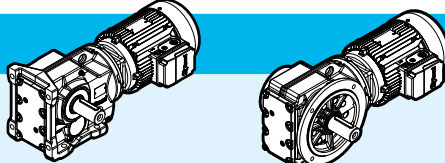

Selection tables [kW]

$P_1 = 0,12 \text{ kW}$											
n_2 min ⁻¹	M_2 N m	i	F_{r2} N	fs		foot		flange			
						HB	HBZ	HB	HBZ		
6,3	182	144,79 ⁽¹⁾	13000	5,1	iO 673 - HB2 63 B 6 B16B		34	36	40	41	195
6,3	183	145,14 ⁽¹⁾	9660	3,7	iO 573 - HB2 63 B 6 B16B		30	32	37	38	192
7,3	156	123,85	9740	4,3							
8,4	136	108,29	9800	4,9							
8,8	130	102,88 ⁽¹⁾	9820	5,2							
10	114	90,26 ⁽¹⁾	9870	5,9							
12	96	76,56 ⁽¹⁾	9920	6,9							
9,4	121	145,14 ⁽¹⁾	9870	5,5	iO 573 - HB2 63 A 4 B16B		29	31	36	38	192
11	104	123,85	9910	6,5							
13	91	108,29	9950	7,4							
13	86	102,88 ⁽¹⁾	9960	7,8							
15	76	90,26 ⁽¹⁾	9990	8,9							
6,9	166	131,87 ⁽¹⁾	7900	2,7	iO 473 - HB2 63 B 6 B16B		23	25	25	27	189
7,5	153	121,48 ⁽¹⁾	7960	2,9							
8,7	131	104,37	8050	3,4							
10	110	131,87 ⁽¹⁾	8140	4,1	iO 473 - HB2 63 A 4 B16B		22	24	25	27	189
11	102	121,48 ⁽¹⁾	8160	4,4							
8,6	134	106,38	5750	1,65	iO 373 - HB2 63 B 6 B12B		19	20	21	22	186
9,3	123	97,81	5860	1,8							
11	105	83,69	6030	2,1							
13	91	72,54	6160	2,5							
13	89	106,38	6220	2,5	iO 373 - HB2 63 A 4 B12B		18	20	20	22	186
14	82	97,81	6290	2,7							
16	70	83,69	6400	3,2							
19	61	72,54	6480	3,7							
20	57	67,8	6520	3,9							

$P_1 = 0,18 \text{ kW}$											
6,3	274	144,79 ⁽¹⁾	13000	3,4	iO 673 - HB2 71 A 6 B16B		36	38	41	44	195
7,4	233	123,54	13000	4							
8,4	204	108,03	13000	4,5							
8,9	194	102,62	13000	4,8							
9,4	183	144,79 ⁽¹⁾	13000	5,1	iO 673 - HB2 63 B 4 B16B		34	36	40	41	195
11	156	123,54	13000	5,9							
13	137	108,03	13000	6,7							

⁽¹⁾ Finite transmission ratio i

$P_1 = 0,18 \text{ kW}$											
n_2 min ⁻¹	M_2 N m	i	F_{r2} N	fs		foot		flange			
						HB	HBZ	HB	HBZ		
6,3	274	145,14 ⁽¹⁾	9380	2,4	iO 573 - HB2 71 A 6 B16B		31	34	38	41	192
7,3	234	123,85	9520	2,9							
8,4	205	108,29	9620	3,3							
8,8	194	102,88 ⁽¹⁾	9650	3,4							
10	171	90,26 ⁽¹⁾	9720	3,9							
9,4	183	145,14 ⁽¹⁾	9690	3,7	iO 573 - HB2 63 B 4 B16B		30	32	37	38	192
11	157	123,85	9770	4,3							
13	137	108,29	9820	4,9							
13	130	102,88 ⁽¹⁾	9840	5,2							
15	114	90,26 ⁽¹⁾	9890	5,9							
18	97	76,56 ⁽¹⁾	9930	6,9							
6,9	249	131,87 ⁽¹⁾	7480	1,8	iO 473 - HB2 71 A 6 B16B		24	27	27	30	189
7,5	229	121,48 ⁽¹⁾	7600	1,95							
8,7	197	104,37	7790	2,3							
10	172	90,86	7920	2,6							
11	161	85,12 ⁽¹⁾	7960	2,8							
10	167	131,87 ⁽¹⁾	7940	2,7	iO 473 - HB2 63 B 4 B16B		23	25	25	27	189
11	154	121,48 ⁽¹⁾	8000	2,9							
13	132	104,37	8080	3,4							
15	115	90,86	8130	3,9							
16	108	85,12 ⁽¹⁾	8150	4,2							
8,6	201	106,38	5210	1,1	iO 373 - HB2 71 A 6 B12B			20	23	22	25
9,3	185	97,81	5360	1,2							
11	158	83,69	5600	1,4							
13	137	72,54	5790	1,65							
13	134	106,38	5820	1,65	iO 373 - HB2 63 B 4 B12B		19	20	21	22	186
14	124	97,81	5920	1,8							
16	106	83,69	6080	2,1							
19	92	72,54	6200	2,4							
20	86	67,8	6260	2,6							
23	74	58,6	6210	3							
27	63	49,79	5950	3,6							
31	56	44,46	5770	4							
36	48	37,97	5520	4,7							

$P_1 = 0,25 \text{ kW}$											
4,7	510	192,18	19700	3,1	iO 773 - HB2 71 B 6 B20B		55	58	63	66	198
5,0	476	179,37	19800	3,4							
5,8	409	154,02	19900	4,3							
6,7	359	135,28	19900	4,9							
6,2	384	144,79 ⁽¹⁾	12900	2,4	iO 673 - HB2 71 B 6 B16B		37	39	42	45	195
7,3	328	123,54	13000	2,8							
8,3	287	108,03	13000	3,2							
8,8	272	102,62	13000	3,4							





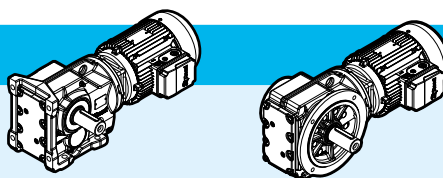





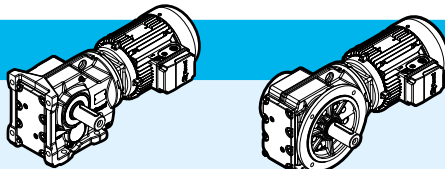

⁽¹⁾ Finite transmission ratio i

$P_1 = 0,25 \text{ kW}$



n_2 min ⁻¹	M_2 N m	i	F_{r2} N	fs		foot		flange		p.	
						HB	HBZ	HB	HBZ		
9,7	247	144,79 ⁽¹⁾	13000	3,7	iO 673 - HB2 71 A 4 B16B		35	38	41	43	195
11	211	123,54	13000	4,4							
13	184	108,03	13000	4,9							
14	175	102,62	13000	5,2							
6,2	385	145,14 ⁽¹⁾	8970	1,75			iO 573 - HB2 71 B 6 B16B		32	35	39
7,3	329	123,85	9200	2							
8,3	287	108,29	9350	2,3							
8,7	273	102,88 ⁽¹⁾	9400	2,5							
10,0	239	90,26 ⁽¹⁾	9520	2,8							
12	203	76,56 ⁽¹⁾	9630	3,3							
9,6	248	145,14 ⁽¹⁾	9480	2,7	iO 573 - HB2 71 A 4 B16B		31	34	38	40	192
11	211	123,85	9600	3,2							
13	185	108,29	9680	3,6							
14	175	102,88 ⁽¹⁾	9710	3,8							
16	154	90,26 ⁽¹⁾	9770	4,4							
18	131	76,56 ⁽¹⁾	9840	5,1							
6,8	350	131,87 ⁽¹⁾	6620	1,3	iO 473 - HB2 71 B 6 B16B		25	28	28	30	189
7,4	322	121,48 ⁽¹⁾	6900	1,4							
8,6	277	104,37	7290	1,65							
9,9	241	90,86	7550	1,85							
11	226	85,12 ⁽¹⁾	7640	2							
11	225	131,87 ⁽¹⁾	7630	2	iO 473 - HB2 71 A 4 B16B		24	27	27	29	189
12	207	121,48 ⁽¹⁾	7740	2,2							
13	178	104,37	7890	2,5							
15	155	90,86	7990	2,9							
16	145	85,12 ⁽¹⁾	8020	3,1							
11	222	83,69	5040	1			iO 373 - HB2 71 B 6 B12B		21	24	23
12	192	72,54	5310	1,15							
13	180	67,8	5420	1,25							
15	155	58,6	5640	1,45							
18	132	49,79	5850	1,7							
13	181	106,38	5380	1,25	iO 373 - HB2 71 A 4 B12B		20	22	22	24	186
14	167	97,81	5520	1,35							
17	143	83,69	5740	1,55							
19	124	72,54	5910	1,8							
21	116	67,8	5980	1,95							
24	100	58,6	5920	2,2							
28	85	49,79	5700	2,6							
31	76	44,46	5540	3							
37	65	37,97	5320	3,5							
39	61	35,57	5230	3,7							
47	51	29,96	5000	4,4							
49	49	28,83	4940	4,6							

⁽¹⁾Finite transmission ratio i

$P_1 = 0,37 \text{ kW}$												
n_2 min ⁻¹	M_2 N m	i	F_{r2} N	fs		foot		flange				
						HB	HBZ	HB	HBZ			
4,7	750	197,37	28900	4	iO 873 - HB2 80 A 6 B25C		103	107	108	112	201	
5,3	662	174,19	28900	4,5								
6,0	585	154,02	19500	3	iO 773 - HB2 80 A 6 B20C		56	60	64	68	198	
6,9	514	135,28	19700	3,4								
7,2	488	128,52	19700	3,6								
8,2	431	113,56	19800	4,1								
7,3	485	192,18	19700	3,3			iO 773 - HB2 71 B 4 B20B		55	58	63	65
7,8	453	179,37	19800	3,5								
9,1	389	154,02	19900	4,5								
7,5	469	123,54	12600	1,95	iO 673 - HB2 80 A 6 B16C				38	42	43	47
8,6	410	108,03	12800	2,3								
9,1	390	102,62	12900	2,4								
10	342	90,04	13000	2,7								
9,7	365	144,79 ⁽¹⁾	12900	2,5	iO 673 - HB2 71 B 4 B16B		36	39	42	44	195	
11	312	123,54	13000	2,9								
13	273	108,03	13000	3,3								
16	227	90,04	13000	4								
18	193	76,37	13000	4,7								
7,5	471	123,85	8570	1,4			iO 573 - HB2 80 A 6 B16C		33	37	40	44
8,6	411	108,29	8840	1,65								
9,0	391	102,88 ⁽¹⁾	8930	1,7								
10	343	90,26 ⁽¹⁾	9130	1,95								
12	291	76,56 ⁽¹⁾	9320	2,3								
13	263	69,12	9430	2,6								
9,6	366	145,14 ⁽¹⁾	9040	1,85	iO 573 - HB2 71 B 4 B16B				32	35	39	41
11	313	123,85	9250	2,1								
13	273	108,29	9390	2,5								
14	260	102,88 ⁽¹⁾	9440	2,6								
16	228	90,26 ⁽¹⁾	9550	2,9								
18	193	76,56 ⁽¹⁾	9660	3,5								
20	174	69,12	9720	3,8								
8,9	397	104,37	6000	1,15	iO 473 - HB2 80 A 6 B16C		26	30	29	33	189	
10	345	90,86	6630	1,3								
11	323	85,12 ⁽¹⁾	6860	1,4								
12	286	75,2 ⁽¹⁾	7200	1,55								
11	333	131,87 ⁽¹⁾	6780	1,35	iO 473 - HB2 71 B 4 B16B		25	28	27	30	189	
12	307	121,48 ⁽¹⁾	7030	1,45								
13	263	104,37	7380	1,7								
15	229	90,86	7610	1,95								
16	215	85,12 ⁽¹⁾	7700	2,1								
19	190	75,2 ⁽¹⁾	7840	2,4								
20	176	69,84	7900	2,6								
22	160	63,3 ⁽¹⁾	7970	2,8								

⁽¹⁾ Finite transmission ratio i

$P_1 = 0,37 \text{ kW}$

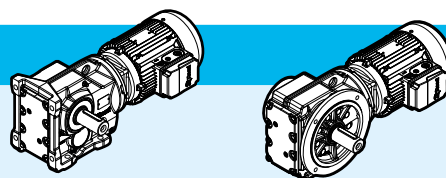





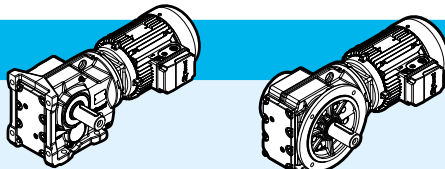

n_2 min ⁻¹	M_2 N m	i	F_{r2} N	fs	iO 373 - HB2 71 B 4 B12B	foot		flange		186
						HB	HBZ	HB	HBZ	
14	247	97,81	3550	0,9		21	23	23	25	
17	211	83,69	5130	1,05						
19	183	72,54	5380	1,2						
21	171	67,8	5490	1,3						
24	148	58,6	5480	1,5						
28	126	49,79	5320	1,8						
31	112	44,46	5200	2						
37	96	37,97	5030	2,3						
39	90	35,57	4960	2,5						
47	76	29,96	4770	3						
49	73	28,83	4720	3,1						
56	63	24,99	4560	3,6						
60	59	23,36	4480	3,7						
69	51	20,19	4320	4						
82	43	17,15	4130	4,6						

$P_1 = 0,55 \text{ kW}$

4,7	1127	197,37	28700	2,7	iO 873 - HB2 80 B 6 B25C		104	108	109	113	201
5,3	994	174,19	28800	3							
5,6	938	164,34 ⁽¹⁾	28800	3,2							
6,2	841	147,32 ⁽¹⁾	28900	3,6							
6,0	879	154,02	18900	2	iO 773 - HB2 80 B 6 B20C		58	62	65	69	198
6,8	772	135,28	19200	2,3							
7,2	734	128,52	19300	2,4							
8,1	648	113,56	19500	2,7							
9,1	576	154,02	19600	3	iO 773 - HB2 80 A 4 B20C		56	60	63	67	198
10	506	135,28	19700	3,5							
11	480	128,52	19700	3,6							
12	425	113,56	19800	4,1							
14	363	97,05	19900	4,8							
7,4	705	123,54	11500	1,3	iO 673 - HB2 80 B 6 B16C			39	43	45	49
8,5	617	108,03	12000	1,5							
9,0	586	102,62	12100	1,6							
10	514	90,04	12500	1,8							
12	436	76,37	12800	2,1							
11	462	123,54	12600	2	iO 673 - HB2 80 A 4 B16C		37	41	43	47	195
13	404	108,03	12800	2,3							
16	337	90,04	13000	2,7							
18	286	76,37	13000	3,2							

⁽¹⁾Finite transmission ratio i

$P_1 = 0,55 \text{ kW}$											
n_2	M_2	i	F_{r2}	fs		foot		flange			
min ⁻¹	N m		N			HB	HBZ	HB	HBZ		
8,5	618	108,29	7720	1,1	iO 573 - HB2 80 B 6 B16C		35	39	42	45	192
8,9	587	102,88 ⁽¹⁾	7960	1,15							
10	515	90,26 ⁽¹⁾	8460	1,3							
12	437	76,56 ⁽¹⁾	8810	1,55							
13	395	69,12	8980	1,7							
15	347	60,81 ⁽¹⁾	9170	1,95							
16	328	57,42 ⁽¹⁾	9240	2							
11	463	123,85	8640	1,45	iO 573 - HB2 80 A 4 B16C		33	37	40	43	192
13	405	108,29	8900	1,65							
14	385	102,88 ⁽¹⁾	8980	1,75							
16	337	90,26 ⁽¹⁾	9170	2							
18	286	76,56 ⁽¹⁾	9360	2,3							
20	258	69,12	9460	2,6							
23	227	60,81 ⁽¹⁾	9560	2,9							
24	215	57,42 ⁽¹⁾	9600	3,1							
13	390	104,37	6170	1,15	iO 473 - HB2 80 A 4 B16C		26	30	28	32	189
15	340	90,86	6750	1,3							
17	318	85,12 ⁽¹⁾	6950	1,4							
19	281	75,2 ⁽¹⁾	7270	1,6							
20	261	69,84	7420	1,7							
22	237	63,3 ⁽¹⁾	7580	1,9							
25	212	56,83	7730	2,1							
29	183	48,95 ⁽¹⁾	7880	2,5							
31	172	46,03 ⁽¹⁾	7930	2,6							
24	219	58,6	4830	1	iO 373 - HB2 80 A 4 B12C		22	26	24	28	186
28	186	49,79	4760	1,2							
32	166	44,46	4700	1,35							
37	142	37,97	4600	1,6							
40	133	35,57	4560	1,7							
47	112	29,96	4420	2							
49	108	28,83	4390	2,1							
56	93	24,99	4270	2,4							
60	87	23,36	4210	2,5							
70	75	20,19	4080	2,7							
82	64	17,15	3930	3,1							
92	57	15,31	3830	3,4							
107	49	13,08	3680	3,8							
116	45	12,14	3610	4							
134	39	10,49	3470	4,6							

⁽¹⁾ Finite transmission ratio i

$P_1 = 0,75 \text{ kW}$

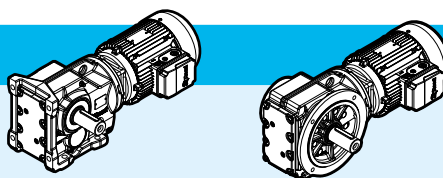









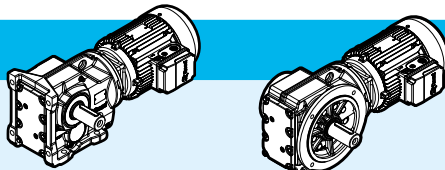

kg

p.

n_2 min ⁻¹	M_2 N m	i	F_{r2} N	fs		foot		flange			
						HB	HBZ	HB	HBZ		
5,3	1342	174,19	28600	2,2	iO 873 - HB3 90 S 6 B25D		110	114	115	119	201
5,7	1266	164,34 ⁽¹⁾	28700	2,4							
6,3	1135	147,32 ⁽¹⁾	28700	2,6							
7,3	977	126,91 ⁽¹⁾	28800	3,1							
7,1	1003	197,37	28800	3	iO 873 - HB3 80 B 4 B25C		107	111	112	116	201
8,1	885	174,19	28800	3,4							
8,6	835	164,34 ⁽¹⁾	28900	3,6							
9,6	748	147,32 ⁽¹⁾	28900	4							
6,9	1042	135,28	18300	1,7	iO 773 - HB3 90 S 6 B20D		64	68	71	75	198
7,2	990	128,52	18400	1,75							
8,2	875	113,56	18800	2							
9,6	747	97,05	19200	2,3							
10	685	88,97	19300	2,6							
9,2	782	154,02	19100	2,2	iO 773 - HB3 80 B 4 B20C		60	64	68	72	198
10	687	135,28	19300	2,5							
11	653	128,52	19400	2,7							
12	577	113,56	19600	3							
15	493	97,05	19700	3,5							
11	628	123,54	11800	1,45	iO 673 - HB3 80 B 4 B16C		42	46	47	51	195
13	549	108,03	12200	1,65							
16	457	90,04	12600	2							
18	388	76,37	12900	2,3							
20	350	68,95	13000	2,6							
23	308	60,66	13000	2,9							
25	291	57,28	13000	3,1							
11	629	123,85	7500	1,05	iO 573 - HB3 80 B 4 B16C		37	41	44	48	192
13	550	108,29	8120	1,2							
14	523	102,88 ⁽¹⁾	8330	1,3							
16	459	90,26 ⁽¹⁾	8660	1,45							
18	389	76,56 ⁽¹⁾	8960	1,7							
20	351	69,12	9120	1,9							
23	309	60,81 ⁽¹⁾	9280	2,2							
25	292	57,42 ⁽¹⁾	9340	2,3							
29	248	48,89	9490	2,7							
32	226	44,43	9560	3							
19	382	75,2 ⁽¹⁾	6270	1,2	iO 473 - HB3 80 B 4 B16C		30	34	33	37	189
20	355	69,84	6590	1,25							
22	322	63,3 ⁽¹⁾	6920	1,4							
25	289	56,83	7210	1,55							
29	249	48,95 ⁽¹⁾	7500	1,8							
31	234	46,03 ⁽¹⁾	7600	1,9							
36	201	39,61	7790	2,2							
40	180	35,39	7690	2,5							
45	159	31,3	7480	2,8							

⁽¹⁾Finite transmission ratio i





$P_1 = 0,75 \text{ kW}$											
n_2	M_2	i	F_{r2}	fs	iO 373 - HB3 80 B 4 B12C		foot		flange		
min ⁻¹	N m		N	HB			HBZ	HB	HBZ		
32	226	44,46	4170	1			26	30	28	32	186
37	193	37,97	4140	1,15							
40	181	35,57	4130	1,25							
47	152	29,96	4060	1,45							
49	146	28,83	4040	1,55							
56	127	24,99	3970	1,75							
60	119	23,36	3930	1,85							
70	103	20,19	3840	2							
82	87	17,15	3720	2,3							
92	78	15,31	3640	2,5							
108	66	13,08	3520	2,8							
116	62	12,14	3460	2,9							
134	53	10,49	3340	3,4							
158	45	8,91	3210	4							
177	40	7,96	3120	4,3							

$P_1 = 1,1 \text{ kW}$											
5,3	1989	176,05 ⁽¹⁾	40000	2,4	iO 973 - HB3 90 L 6 B30D		174	180	190	197	204
6,1	1731	153,21 ⁽¹⁾	40000	2,8							
6,6	1585	140,28	40000	3,1							
7,5	1400	123,93 ⁽¹⁾	40000	3,5							
8,1	1302	176,05 ⁽¹⁾	40000	3,7	iO 973 - HB3 90 S 4 B30D		173	177	189	193	204
9,3	1133	153,21 ⁽¹⁾	40000	4,3							
10	1038	140,28	40000	4,7							
6,3	1664	147,32 ⁽¹⁾	28400	1,8	iO 873 - HB3 90 L 6 B25D		114	120	119	126	201
7,3	1434	126,91 ⁽¹⁾	28500	2,1							
8,2	1289	174,19	28600	2,3	iO 873 - HB3 90 S 4 B25D		113	117	118	122	201
8,6	1216	164,34 ⁽¹⁾	28700	2,5							
9,6	1090	147,32 ⁽¹⁾	28800	2,8							
11	939	126,91 ⁽¹⁾	28800	3,2							
12	857	115,82	28900	3,5							
8,2	1283	113,56	17200	1,35	iO 773 - HB3 90 L 6 B20D		68	74	75	82	198
9,6	1096	97,05	18000	1,6							
10	1001	135,28	18400	1,75	iO 773 - HB3 90 S 4 B20D		67	71	74	78	198
11	951	128,52	18600	1,85							
13	840	113,56	18900	2,1							
15	718	97,05	19300	2,4							
16	658	88,97	19400	2,7							
18	578	78,07	19600	3							
19	547	73,99	19600	3,2							

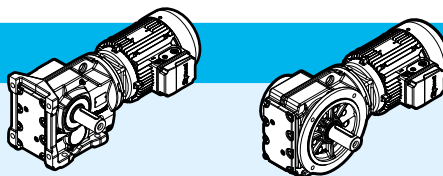

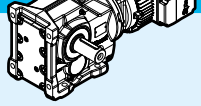
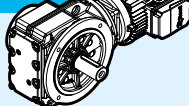

⁽¹⁾ Finite transmission ratio i



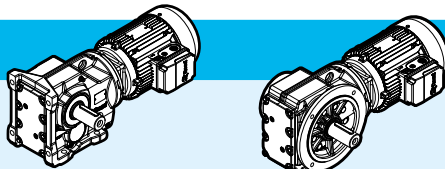

$P_1 = 1,1 \text{ kW}$



n_2 min ⁻¹	M_2 N m	i	F_{r2} N	fs	 	foot		flange		p.	
						HB	HBZ	HB	HBZ		
13	799	108,03	10700	1,15	iO 673 - HB3 90 S 4 B16D		48	52	54	58	195
14	759	102,62	11000	1,2							
16	666	90,04	11600	1,35							
19	565	76,37	12200	1,6							
21	510	68,95	12400	1,75							
23	449	60,66	12700	2							
25	424	57,28	12800	2,1							
29	361	48,77	13000	2,5							
32	328	44,32	13000	2,7							
37	284	38,39	13000	3,1							
16	668	90,26 ⁽¹⁾	6280	1	iO 573 - HB3 90 S 4 B16D		44	48	51	55	192
19	566	76,56 ⁽¹⁾	8010	1,2							
21	511	69,12	8420	1,3							
23	450	60,81 ⁽¹⁾	8710	1,5							
25	425	57,42 ⁽¹⁾	8820	1,6							
29	362	48,89	9080	1,85							
32	329	44,43	9210	2							
37	285	38,49	9370	2,4							
40	264	35,7	9440	2,5							
47	224	30,28	9570	3							
52	202	27,34	9430	3,3							
59	178	24,05	9130	3,8							
63	168	22,71	9000	4							
73	143	19,34	8640	4,5							
81	130	17,57	8420	4,7							
93	113	15,22	8100	5,3							
107	98	13,25	7790	5,9							
119	88	11,92	7490	5,2							
126	83	11,26	7370	5,5							
148	71	9,59	7040	6,3							
163	64	8,71	6850	6,7							
188	56	7,55	6570	7,2							
216	49	6,57	6310	7,8							
25	420	56,83	5430	1,05	iO 473 - HB3 90 S 4 B16D		37	41	39	43	189
29	362	48,95 ⁽¹⁾	6520	1,25							
31	341	46,03 ⁽¹⁾	6750	1,3							
36	293	39,61	7160	1,55							
40	262	35,39	7050	1,7							
45	232	31,3	6920	1,95							
48	217	29,32	6840	2,1							
55	192	25,91	6690	2,3							
59	178	24,06	6060	2,5							
65	161	21,81	6460	2,8							
73	145	19,58	6310	3,1							

⁽¹⁾Finite transmission ratio i

$P_1 = 1,1 \text{ kW}$											
n_2	M_2	i	F_{r2}	fs	iO 373 - HB3 90 S 4 B12D		foot		flange		
min ⁻¹	N m		N				HB	HBZ	HB	HBZ	
47	222	29,96	3430	1			32	36	34	38	186
57	185	24,99	3440	1,2							
61	173	23,36	3430	1,25							
70	149	20,19	3410	1,4							
83	127	17,15	3360	1,6							
93	113	15,31	3310	1,7							
109	97	13,08	3240	1,9							
117	90	12,14	3200	2							
135	78	10,49	3120	2,3							
159	66	8,91	3020	2,7							
178	59	7,96	2950	3							
209	50	6,8	2850	3,4							
223	47	6,37	2800	3,4							
265	40	5,36	2690	3,8							

$P_1 = 1,5 \text{ kW}$											
5,4	2655	176,05 ⁽¹⁾	40000	1,85	iO 973 - HB3 100 LA 6 B30E		180	186	197	203	204
6,2	2310	153,21 ⁽¹⁾	40000	2,1							
6,8	2115	140,28	40000	2,3							
7,7	1869	123,93 ⁽¹⁾	40000	2,6							
8,1	1764	176,05 ⁽¹⁾	40000	2,8	iO 973 - HB3 90 L 4 B30D		173	179	190	196	204
9,3	1535	153,21 ⁽¹⁾	40000	3,2							
10	1405	140,28	40000	3,5							
12	1241	123,93 ⁽¹⁾	40000	3,9							
6,4	2222	147,32 ⁽¹⁾	27900	1,35	iO 873 - HB3 100 LA 6 B25E		123	129	129	135	201
7,5	1914	126,91 ⁽¹⁾	28200	1,55							
8,2	1746	115,82	28300	1,7							
9,2	1549	102,71 ⁽¹⁾	28400	1,95							
8,2	1745	174,19	28300	1,7	iO 873 - HB3 90 L 4 B25D		113	119	119	125	201
8,7	1646	164,34 ⁽¹⁾	28400	1,8							
9,7	1476	147,32 ⁽¹⁾	28500	2							
11	1271	126,91 ⁽¹⁾	28600	2,4							
12	1160	115,82	28700	2,6							
14	1029	102,71 ⁽¹⁾	28800	2,9							
17	865	86,34	28900	3,5							
8,4	1712	113,56	14300	1	iO 773 - HB3 100 LA 6 B20E		77	83	85	91	198
9,8	1463	97,05	16100	1,2							
11	1342	88,97	16800	1,3							
12	1177	78,07	17600	1,5							

⁽¹⁾ Finite transmission ratio i

$P_1 = 1,5 \text{ kW}$

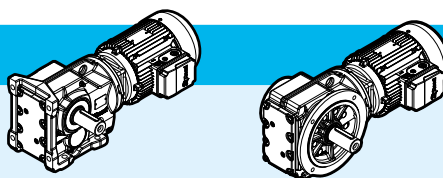







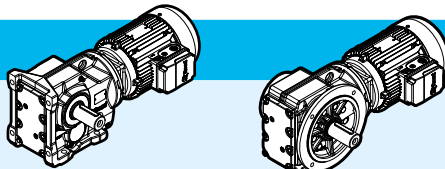

kg

p.

n_2 min ⁻¹	M_2 N m	i	F_{r2} N	fs		foot		flange				
						HB	HBZ	HB	HBZ			
11	1355	135,28	16800	1,3	iO 773 - HB3 90 L 4 B20D		67	73	75	81	198	
11	1287	128,52	17100	1,35								
13	1138	113,56	17800	1,55								
15	972	97,05	18500	1,8								
16	891	88,97	18800	1,95								
18	782	78,07	19100	2,2								
19	741	73,99	19200	2,4								
22	649	64,75	19400	2,7								
25	584	58,34	19600	3								
28	513	51,18	19700	3,4								
32	452	45,16	19800	3,9								
36	401	40,04	19900	4,4								
16	902	90,04	9710	1			iO 673 - HB3 90 L 4 B16D		49	55	54	60
19	765	76,37	10900	1,2								
21	691	68,95	11400	1,3								
24	608	60,66	11900	1,45								
25	574	57,28	12100	1,55								
29	489	48,77	12500	1,8								
32	444	44,32	12700	2								
37	385	38,39	12900	2,3								
40	357	35,62	13000	2,5								
47	303	30,22	13000	2,9								
52	273	27,28	13000	3,2								
60	240	24	13000	3,6								
24	609	60,81 ⁽¹⁾	7660	1,1	iO 573 - HB3 90 L 4 B16D		44	50	51	57	192	
25	575	57,42 ⁽¹⁾	7930	1,15								
29	490	48,89	8520	1,35								
32	445	44,43	8720	1,5								
37	386	38,49	8980	1,75								
40	358	35,7	9090	1,85								
47	303	30,28	9130	2,2								
52	274	27,34	8950	2,4								
59	241	24,05	8710	2,8								
63	228	22,71	8600	2,9								
74	194	19,34	8300	3,4								

⁽¹⁾ Finite transmission ratio i

$P_1 = 1,5 \text{ kW}$											
n_2	M_2	i	F_{r2}	fs	iO 473 - HB3 90 L 4 B16D		foot		flange		
min ⁻¹	N m		N	HB			HBZ	HB	HBZ		
36	397	39,61	6080	1,15			37	43	40	46	189
40	355	35,39	6340	1,25							
46	314	31,3	6290	1,45							
49	294	29,32	6250	1,55							
55	260	25,91	6160	1,75							
59	241	24,06	6090	1,85							
66	218	21,81	6020	2,1							
73	196	19,58	5920	2,3							
85	169	16,86	5760	2,5							
90	159	15,86	5690	2,7							
105	137	13,65	5520	2,9							
117	122	12,19	5390	3,2							
122	118	11,77	5300	2,4							
61	234	23,36	2880	0,95	iO 373 - HB3 90 L 4 B12D		33	39	35	41	186
71	202	20,19	2920	1							
83	172	17,15	2950	1,15							
93	153	15,31	2940	1,25							
109	131	13,08	2920	1,4							
118	122	12,14	2910	1,5							
136	105	10,49	2870	1,7							
160	89	8,91	2810	2							
180	80	7,96	2760	2,2							
210	68	6,8	2680	2,5							
225	64	6,37	2650	2,5							
267	54	5,36	2560	2,8							

$P_1 = 2,2 \text{ kW}$											
6,3	3353	153,21 ⁽¹⁾	40000	1,45	iO 973 - HB3 112 M 6 B30F		188	197	205	214	204
6,8	3070	140,28	40000	1,6							
7,7	2712	123,93 ⁽¹⁾	40000	1,8							
9,1	2301	105,13	40000	2,1							
8,2	2569	176,05 ⁽¹⁾	40000	1,9	iO 973 - HB3 100 LA 4 B30E		180	186	197	203	204
9,4	2235	153,21 ⁽¹⁾	40000	2,2							
10	2047	140,28	40000	2,4							
12	1808	123,93 ⁽¹⁾	40000	2,7							
14	1534	105,13	40000	3,2							
15	1412	96,8	40000	3,4							
9,8	2150	147,32 ⁽¹⁾	27900	1,4	iO 873 - HB3 100 LA 4 B25E		123	129	129	135	201
11	1852	126,91 ⁽¹⁾	28200	1,6							
12	1690	115,82	28300	1,8							
14	1499	102,71 ⁽¹⁾	28500	2							
17	1260	86,34	28600	2,4							
18	1158	79,34	28700	2,6							
20	1028	70,46	28800	2,9							
23	919	63 ⁽¹⁾	28800	3,3							

⁽¹⁾ Finite transmission ratio i

$P_1 = 2,2 \text{ kW}$

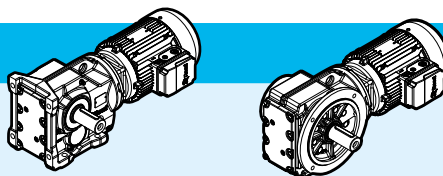







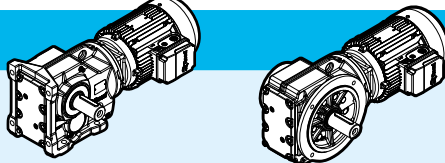

kg

p.

n_2 min ⁻¹	M_2 N m	i	F_{r2} N	fs	iO 773 - HB3 100 LA 4 B20E	foot		flange		198
						HB	HBZ	HB	HBZ	
13	1657	113,56	14700	1,05		77	83	85	91	198
15	1416	97,05	16300	1,25						
16	1298	88,97	17000	1,35						
18	1139	78,07	17800	1,55						
19	1080	73,99	18000	1,6						
22	945	64,75	18500	1,85						
25	851	58,34	18800	2,1						
28	747	51,18	19200	2,3						
32	659	45,16	19400	2,7						
36	584	40,04	19500	3						
41	513	35,2	19700	3,4						
47	451	30,89	19800	3,9						
49	427	29,27	19800	4,1						
56	374	25,62	19900	4,7						
24	885	60,66	9750	1		58	64	64	70	195
25	836	57,28	10200	1,05						
30	712	48,77	11200	1,25						
32	647	44,32	11600	1,35						
38	560	38,39	12100	1,55						
40	520	35,62	12300	1,7						
48	441	30,22	12700	2						
53	398	27,28	12800	2,2						
60	350	24	13000	2,5						
64	331	22,66	13000	2,6						
75	281	19,3	13000	3						
82	256	17,54	13000	3,2						
95	222	15,19	13000	3,5						
109	193	13,22	13000	3,5						
115	182	12,48	13000	2,9						
135	155	10,63	13000	3,2						
149	141	9,66	13000	3,4						
172	122	8,37	13000	3,6						
198	106	7,28	12700	4						
32	648	44,43	7040	1,05		54	60	61	67	192
37	562	38,49	7970	1,2						
40	521	35,7	8290	1,3						
48	442	30,28	8230	1,5						
53	399	27,34	8140	1,7						
60	351	24,05	8000	1,9						
63	331	22,71	7930	2						
74	282	19,34	7730	2,3						
82	256	17,57	7590	2,4						
95	222	15,22	7380	2,7						
109	193	13,25	7170	3						
121	174	11,92	6850	2,7						
128	164	11,26	6770	2,8						

iO

$P_1 = 2,2 \text{ kW}$											
n_2 min ⁻¹	M_2 N m	i	F_{r2} N	fs		foot		flange			
						HB	HBZ	HB	HBZ		
56	378	25,91	5260	1,2	iO 473 - HB3 100 LA 4 B16E		47	53	49	55	189
66	318	21,81	5260	1,4							
74	286	19,58	5240	1,6							
85	246	16,86	5180	1,75							
91	231	15,86	5140	1,85							
106	199	13,65	5050	2							
118	178	12,19	4970	2,2							
122	172	11,77	4870	1,65							
136	154	10,56	4790	1,85							
158	133	9,1	4660	2,1							
110	191	13,08	2380	0,95	iO 373 - HB3 100 LA 4 B12E		42	48	44	50	186
137	153	10,49	2430	1,2							
162	130	8,91	2440	1,4							
181	116	7,96	2430	1,5							
212	99	6,8	2400	1,7							
226	93	6,37	2390	1,7							
269	78	5,36	2340	1,95							

$P_1 = 3 \text{ kW}$											
7,8	3660	123,93 ⁽¹⁾	40000	1,35	iO 973 - HB3 132 S 6 B30G		210	221	226	237	204
9,2	3105	105,13	40000	1,55							
10	2859	96,8	40000	1,7							
11	2556	86,52	40000	1,9							
8,2	3479	176,05 ⁽¹⁾	40000	1,4	iO 973 - HB3 112 MA 4 B30E						
9,5	3027	153,21 ⁽¹⁾	40000	1,6			188	194	205	211	204
10	2772	140,28	40000	1,75							
12	2449	123,93 ⁽¹⁾	40000	2							
14	2077	105,13	40000	2,3							
15	1913	96,8	40000	2,5							
17	1710	86,52	40000	2,8							
19	1539	77,89 ⁽¹⁾	40000	3,2							
21	1394	70,54	40000	3,5							
23	1236	62,55	40000	3,9							
26	1117	56,55	40000	4,4							
9,8	2911	147,32 ⁽¹⁾	27000	1,05	iO 873 - HB3 112 MA 4 B25E		131	137	136	142	201
11	2508	126,91 ⁽¹⁾	27500	1,2							
13	2288	115,82	27800	1,3							
14	2029	102,71 ⁽¹⁾	28000	1,5							
17	1706	86,34	28300	1,75							
18	1568	79,34	28400	1,9							
21	1392	70,46	28600	2,2							
23	1245	63 ⁽¹⁾	28600	2,4							
26	1119	56,64	28700	2,7							
29	971	49,16	28800	3,1							
33	870	44,02	28800	3,3							
40	722	36,52 ⁽¹⁾	28200	3,9							

⁽¹⁾ Finite transmission ratio i

$P_1 = 3 \text{ kW}$

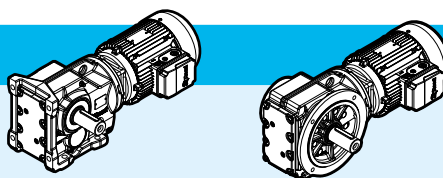





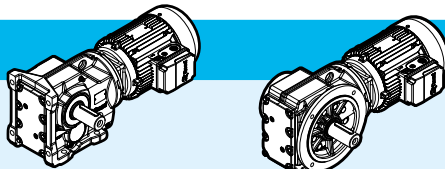

kg

p.

n_2 min ⁻¹	M_2 N m	i	F_{r2} N	fs		foot		flange			
						HB	HBZ	HB	HBZ		
16	1758	88,97	13800	1	iO 773 - HB3 112 MA 4 B20E		86	92	94	100	198
19	1543	78,07	15500	1,15							
20	1462	73,99	16000	1,2							
22	1279	64,75	17100	1,35							
25	1153	58,34	17700	1,5							
28	1011	51,18	18300	1,75							
32	892	45,16	18700	1,95							
36	791	40,04	19000	2,2							
41	695	35,2	19300	2,5							
47	610	30,89	19500	2,9							
33	876	44,32	9820	1	iO 673 - HB3 112 MA 4 B16E		66	72	71	77	195
38	759	38,39	10900	1,15							
41	704	35,62	11300	1,25							
48	597	30,22	11900	1,45							
53	539	27,28	12200	1,6							
60	474	24	12500	1,85							
64	448	22,66	12600	1,95							
75	381	19,3	12900	2,2							
83	346	17,54	13000	2,4							
95	300	15,19	13000	2,6							
110	261	13,22	13000	2,6							
116	247	12,48	13000	2,2							
136	210	10,63	13000	2,4							
150	191	9,66	13000	2,5							
48	598	30,28	7190	1,1	iO 573 - HB3 112 MA 4 B16E		61	67	68	74	192
53	540	27,34	7190	1,25							
60	475	24,05	7170	1,4							
64	449	22,71	7150	1,5							
75	382	19,34	7060	1,7							
83	347	17,57	6980	1,75							
95	301	15,22	6860	2							
109	262	13,25	6710	2,2							
122	236	11,92	6380	1,95							
129	222	11,26	6330	2,1							
151	189	9,59	6160	2,4							
166	172	8,71	6040	2,5							
192	149	7,55	5870	2,7							
221	130	6,57	5700	2,9							

iO

$P_1 = 3 \text{ kW}$											
n_2 min ⁻¹	M_2 N m	i	F_{r2} N	fs		foot		flange			
						HB	HBZ	HB	HBZ		
74	387	19,58	4450	1,15	iO 473 - HB3 112 MA 4 B16E		54	60	57	63	189
86	333	16,86	4500	1,3							
91	313	15,86	4510	1,35							
106	270	13,65	4500	1,5							
119	241	12,19	4480	1,6							
123	232	11,77	4360	1,2							
137	209	10,56	4340	1,35							
159	180	9,1	4280	1,55							
169	169	8,56	4250	1,6							
197	145	7,36	4160	1,75							
220	130	6,58	4090	1,85							
249	115	5,81	4000	2							
163	176	8,91	2020	1			iO 373 - HB3 112 MA 4 B12E		50	56	52
182	157	7,96	2050	1,1							
213	134	6,8	2080	1,25							
228	126	6,37	2090	1,25							
270	106	5,36	2090	1,45							

$P_1 = 4 \text{ kW}$											
9,5	4036	153,21 ⁽¹⁾	40000	1,2	iO 973 - HB3 112 M 4 B30F		190	199	207	216	204
10	3696	140,28	40000	1,3							
12	3265	123,93 ⁽¹⁾	40000	1,5							
14	2770	105,13	40000	1,75							
15	2550	96,8	40000	1,9							
17	2279	86,52	40000	2,1							
19	2052	77,89 ⁽¹⁾	40000	2,4							
21	1858	70,54	40000	2,6							
13	3051	115,82	26900	1	iO 873 - HB3 112 M 4 B25F		133	142	138	147	201
14	2706	102,71 ⁽¹⁾	27300	1,1							
17	2275	86,34	27800	1,3							
18	2090	79,34	28000	1,45							
21	1856	70,46	28200	1,6							
23	1660	63 ⁽¹⁾	28400	1,8							
26	1492	56,64	28500	2							
29	1295	49,16	28600	2,3							
33	1160	44,02	28200	2,5							
40	962	36,52 ⁽¹⁾	27200	2,9							

⁽¹⁾ Finite transmission ratio i

$P_1 = 4 \text{ kW}$

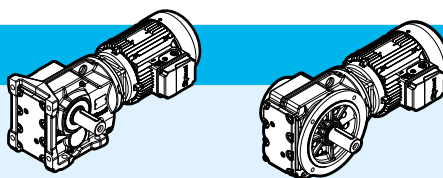





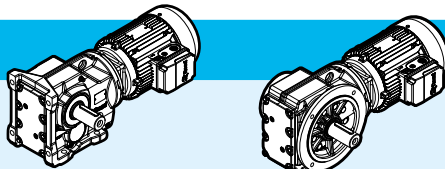

kg

p.

n_2 min ⁻¹	M_2 N m	i	F_{r2} N	fs		foot		flange			
						HB	HBZ	HB	HBZ		
22	1706	64,75	14300	1,05	iO 773 - HB3 112 M 4 B20F		88	97	96	105	198
25	1537	58,34	15600	1,15							
28	1348	51,18	16700	1,3							
32	1190	45,16	17500	1,45							
36	1055	40,04	18100	1,65							
38	1011	38,39	18300	1,7							
41	927	35,2	18600	1,9							
47	814	30,89	19000	2,2							
50	771	29,27	19100	2,3							
57	675	25,62	19300	2,6							
63	608	23,08	19500	2,9							
72	533	20,25	19600	3,2							
48	796	30,22	10600	1,1			iO 673 - HB3 112 M 4 B16F		68	77	73
53	718	27,28	11200	1,2							
60	632	24	11700	1,35							
64	597	22,66	11900	1,45							
75	508	19,3	12400	1,65							
83	462	17,54	12600	1,8							
95	400	15,19	12800	1,9							
110	348	13,22	13000	1,95							
116	329	12,48	13000	1,65							
136	280	10,63	13000	1,8							
150	254	9,66	12800	1,9							
173	220	8,37	12400	2							
199	192	7,28	12000	2,2							
60	634	24,05	6140	1,05	iO 573 - HB3 112 M 4 B16F		63	72	70	79	192
64	598	22,71	6180	1,1							
75	509	19,34	6230	1,3							
83	463	17,57	6230	1,35							
95	401	15,22	6200	1,5							
109	349	13,25	6140	1,65							
122	314	11,92	5800	1,45							
129	297	11,26	5780	1,55							
151	253	9,59	5680	1,8							
166	230	8,71	5620	1,9							
192	199	7,55	5500	2							
221	173	6,57	5380	2,2							

iO

$P_1 = 5,5 \text{ kW}$											
n_2	M_2	i	F_{r2}	fs	iO 973 - HB3 132 S 4 B30G		foot		flange		
min ⁻¹	N m		N	HB			HBZ	HB	HBZ		
12	4428	123,93 ⁽¹⁾	40000	1,1			214	225	230	241	204
14	3756	105,13	40000	1,3							
15	3459	96,8	40000	1,4							
17	3092	86,52	40000	1,6							
19	2783	77,89 ⁽¹⁾	40000	1,75							
21	2520	70,54	40000	1,95							
24	2235	62,55	40000	2,2							
26	2021	56,55	39600	2,4							
31	1713	47,93 ⁽¹⁾	38400	2,8							
17	3085	86,34	26700	0,95	iO 873 - HB3 132 S 4 B25G		158	169	163	174	201
19	2835	79,34	27100	1,05							
21	2518	70,46	27500	1,2							
23	2251	63 ⁽¹⁾	27400	1,35							
26	2024	56,64	27200	1,5							
30	1757	49,16	26800	1,7							
33	1573	44,02	26400	1,85							
40	1305	36,52 ⁽¹⁾	25700	2,1							
47	1121	31,39	25100	2,7							
53	996	27,88	24600	2,9							
33	1614	45,16	14800	1,1	iO 773 - HB3 132 S 4 B20G		110	121	118	129	198
37	1431	40,04	16100	1,2							
48	1103	30,89	17900	1,6							
50	1046	29,27	18100	1,65							
57	915	25,62	18600	1,9							
64	825	23,08	18900	2,1							
73	723	20,25	19200	2,4							
82	638	17,87	19400	2,5							
93	566	15,84	19100	2,7							
109	483	13,52	18500	3,1							
119	441	12,36	17800	2,4							
136	387	10,84	17400	2,6							
61	857	24	9910	1	iO 673 - HB3 132 S 4 B16G		91	102	97	108	195
65	810	22,66	10400	1,05							
76	689	19,3	11300	1,25							
84	626	17,54	11700	1,3							
97	543	15,19	12200	1,4							
111	472	13,22	12500	1,4							
118	446	12,48	12600	1,2							
138	380	10,63	12400	1,3							
152	345	9,66	12200	1,4							
176	299	8,37	11900	1,45							
202	260	7,28	11600	1,6							

⁽¹⁾ Finite transmission ratio i

$P_1 = 7,5 \text{ kW}$

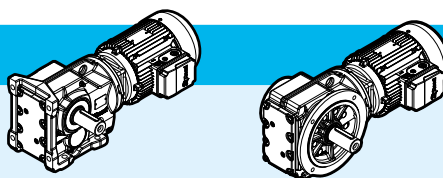







kg

p.

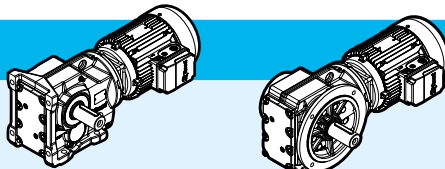
n_2 min ⁻¹	M_2 N m	i	F_{r2} N	fs		foot		flange			
						HB	HBZ	HB	HBZ		
15	4749	96,8	38400	1,05	iO 973 - HB3 132 M 4 B30G		222	233	238	249	204
17	4245	86,52	38300	1,15							
19	3821	77,89 ⁽¹⁾	38100	1,25							
21	3460	70,54	37800	1,4							
23	3069	62,55	37400	1,6							
26	2774	56,55	37000	1,75							
30	2351	47,93 ⁽¹⁾	36200	2,1							
35	2054	41,87	35500	2,4							
38	1878	38,3	35000	2,6							
43	1679	34,23	34300	2,9							
23	3091	63 ⁽¹⁾	24100	0,95	iO 873 - HB3 132 M 4 B25G		166	177	171	182	201
26	2779	56,64	24200	1,1							
30	2412	49,16	24200	1,25							
33	2160	44,02	24100	1,35							
40	1792	36,52 ⁽¹⁾	23800	1,55							
47	1540	31,39	23400	1,95							
52	1367	27,88	23100	2,1							
59	1222	24,92	22700	2,3							
65	1099	22,41	22400	2,3							
75	954	19,45	21800	2,7							
84	854	17,42	21400	2,8							
91	785	16	20500	2,5							
101	709	14,45	20600	3,3							
47	1515	30,89	15700	1,15	iO 773 - HB3 132 M 4 B20G		118	129	126	137	198
50	1436	29,27	16200	1,2							
57	1257	25,62	17200	1,4							
63	1132	23,08	17800	1,55							
72	993	20,25	18400	1,7							
82	876	17,87	18500	1,85							
92	777	15,84	18200	2							
108	663	13,52	17700	2,3							
118	606	12,36	17000	1,7							
135	532	10,84	16600	1,85							
153	469	9,56	16200	2							
172	416	8,48	15800	2,1							
202	355	7,24	15300	2,3							

iO

⁽¹⁾Finite transmission ratio i

$P_1 = 9,2 \text{ kW}$											
n_2 min ⁻¹	M_2 N m	i	F_{r2} N	fs		foot		flange			
						HB	HBZ	HB	HBZ		
19	4687	77,89 ⁽¹⁾	35100	1,05	iO 973 - HB3 132 MB 4 B30H		224	236	241	253	204
21	4245	70,54	35100	1,15							
23	3764	62,55	35000	1,3							
26	3403	56,55	34800	1,45							
30	2884	47,93 ⁽¹⁾	34400	1,7							
35	2519	41,87	33900	1,95							
38	2304	38,3	33500	2,1							
43	2059	34,23	33000	2,4							
47	1854	30,82	32400	2,6							
52	1679	27,91	31900	2,9							
59	1489	24,75	31200	3,3							
30	2958	49,16	22000	1	iO 873 - HB3 132 MB 4 B25H		168	180	174	186	201
33	2649	44,02	22200	1,1							
40	2198	36,52 ⁽¹⁾	22200	1,25							
47	1889	31,39	22000	1,6							
52	1677	27,88	21900	1,75							
59	1499	24,92	21600	1,85							
65	1348	22,41	21400	1,9							
75	1170	19,45	21000	2,2							
84	1048	17,42	20600	2,3							
91	963	16	19700	2							
101	869	14,45	20000	2,7							
116	756	12,56	19500	3							
131	672	11,17	18500	2,5							
146	601	10	18200	2,8							
63	1389	23,08	16500	1,25	iO 773 - HB3 132 MB 4 B20H		121	133	129	141	198
72	1218	20,25	17400	1,4							
82	1075	17,87	17600	1,5							
92	953	15,84	17300	1,65							
108	814	13,52	17000	1,85							
118	743	12,36	16200	1,4							
135	652	10,84	15900	1,55							
153	575	9,56	15600	1,65							
172	510	8,48	15300	1,75							
202	436	7,24	14900	1,9							



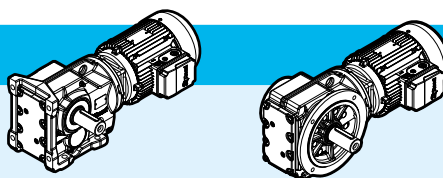

⁽¹⁾ Finite transmission ratio i

$P_1 = 11 \text{ kW}$







kg

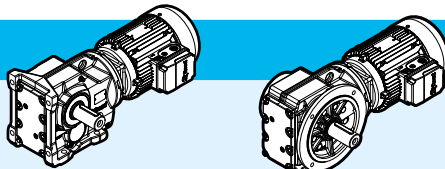

p.

n_2 min ⁻¹	M_2 N m	i	F_{r2} N	fs		foot		flange			
						HB	HBZ	HB	HBZ		
21	5041	70,54	32300	0,95	iO 973 - HB3 160 M 4 B30H		172	-	188	-	204
24	4470	62,55	32500	1,1							
26	4041	56,55	32500	1,2							
31	3425	47,93 ⁽¹⁾	32400	1,4							
35	2992	41,87	32200	1,65							
38	2736	38,3	31900	1,8							
43	2446	34,23	31600	2							
48	2202	30,82	31200	2,2							
53	1994	27,91	30700	2,4							
59	1768	24,75	30200	2,8							
66	1599	22,37	29700	3							
33	3146	44,02	20100	0,9	iO 873 - HB3 160 M 4 B25H		114	-	119	-	201
40	2610	36,52 ⁽¹⁾	20500	1,05							
47	2243	31,39	20600	1,35							
53	1992	27,88	20500	1,45							
59	1781	24,92	20400	1,55							
66	1601	22,41	20300	1,6							
76	1390	19,45	20000	1,85							
84	1244	17,42	19800	1,95							
92	1143	16	18800	1,7							
102	1032	14,45	19300	2,3							
117	898	12,56	18900	2,5							
132	798	11,17	17900	2,1							
147	714	10	17600	2,4							
177	593	8,29	17000	2,6							
204	515	7,21	16600	2,8							
64	1649	23,08	14700	1,05	iO 773 - HB3 160 M 4 B20H		65	-	73	-	198
73	1447	20,25	16100	1,2							
82	1277	17,87	16600	1,25							
93	1132	15,84	16500	1,35							
109	966	13,52	16200	1,55							
119	883	12,36	15500	1,2							
136	774	10,84	15300	1,3							
154	683	9,56	15000	1,4							
173	606	8,48	14800	1,45							
203	517	7,24	14400	1,6							

iO

⁽¹⁾Finite transmission ratio i

$P_1 = 15 \text{ kW}$											
n_2	M_2	i	F_{r2}	fs		foot		flange			
min ⁻¹	N m		N			HB	HBZ	HB	HBZ		
31	4671	47,93 ⁽¹⁾	28100	1,05	IO 973 - HB3 160 L 4 B30H		172	-	188	-	204
35	4080	41,87	28400	1,2							
38	3731	38,3	28500	1,3							
43	3335	34,23	28500	1,45							
48	3002	30,82	28400	1,6							
53	2719	27,91	28200	1,8							
59	2411	24,75	28000	2							
66	2180	22,37	27700	2,2							
78	1848	18,96	27100	2,6							
89	1614	16,56	26600	3							
47	3058	31,39	17300	1	IO 873 - HB3 160 L 4 B25H		114	-	119	-	201
53	2716	27,88	17600	1,05							
59	2428	24,92	17900	1,15							
66	2183	22,41	18000	1,2							
76	1895	19,45	18000	1,35							
84	1697	17,42	18000	1,45							
92	1559	16	16800	1,25							
102	1408	14,45	17800	1,7							
117	1224	12,56	17600	1,85							
132	1088	11,17	16600	1,55							
147	974	10	16400	1,75							
177	808	8,29	16000	1,9							
204	703	7,21	15700	2,1							

$P_1 = 18,5 \text{ kW}$											
35	5049	41,87	25100	0,95	IO 973 - HB3 180 M 4 B30L		172	-	188	-	204
48	3715	30,82	26000	1,3							
53	3365	27,91	26000	1,45							
59	2984	24,75	26000	1,65							
65	2698	22,37	25900	1,8							
77	2286	18,96	25600	2,1							
88	1997	16,56	25300	2,4							
106	1670	13,85	24700	2,7							
122	1446	11,99	24200	3							
59	3005	24,92	15600	0,95			IO 873 - HB3 180 M 4 B25L		114	-	119
65	2702	22,41	15900	0,95							
75	2345	19,45	16200	1,1							
84	2100	17,42	16400	1,15							
101	1742	14,45	16500	1,35							
117	1515	12,56	16400	1,5							
131	1346	11,17	15400	1,25							
147	1205	10	15300	1,4							
177	1000	8,29	15100	1,55							
203	870	7,21	14900	1,65							

⁽¹⁾ Finite transmission ratio i

$P_1 = 22 \text{ kW}$

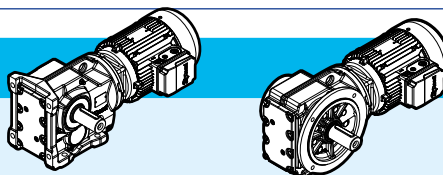

n_2 min ⁻¹	M_2 N m	i	F_{r2} N	fs		foot		flange		p.	
						HB	HBZ	HB	HBZ		
48	4403	30,82	23500	1,1	iO 973 - HB3 180 L 4 B30L		172	-	188	-	204
53	3988	27,91	23800	1,2							
59	3536	24,75	24100	1,4							
66	3197	22,37	24200	1,5							
78	2710	18,96	24100	1,8							
89	2367	16,56	24000	2,1							
106	1979	13,85	23700	2,3							
123	1714	11,99	23300	2,5							
141	1488	10,41	21800	2,1							
169	1244	8,71	21300	2,3							
76	2779	19,45	14500	0,9	iO 873 - HB3 180 L 4 B25L		114	-	119	-	201
84	2489	17,42	14800	1							
102	2065	14,45	15200	1,15							
117	1795	12,56	15300	1,25							
132	1595	11,17	14200	1,05							
147	1429	10	14300	1,2							
177	1185	8,29	14300	1,3							
204	1031	7,21	14200	1,4							

$P_1 = 30 \text{ kW}$

59	4822	24,75	19600	1	iO 973 - HB3 200 L 4 B30M		178	-	194	-	204
66	4360	22,37	20200	1,1							
78	3695	18,96	20700	1,3							
89	3227	16,56	21000	1,5							
106	2699	13,85	21200	1,7							
123	2337	11,99	21100	1,85							
141	2029	10,41	19500	1,55							
169	1697	8,71	19400	1,7							

page intentionally left blank

Bevel helical Dimensional drawings - iO

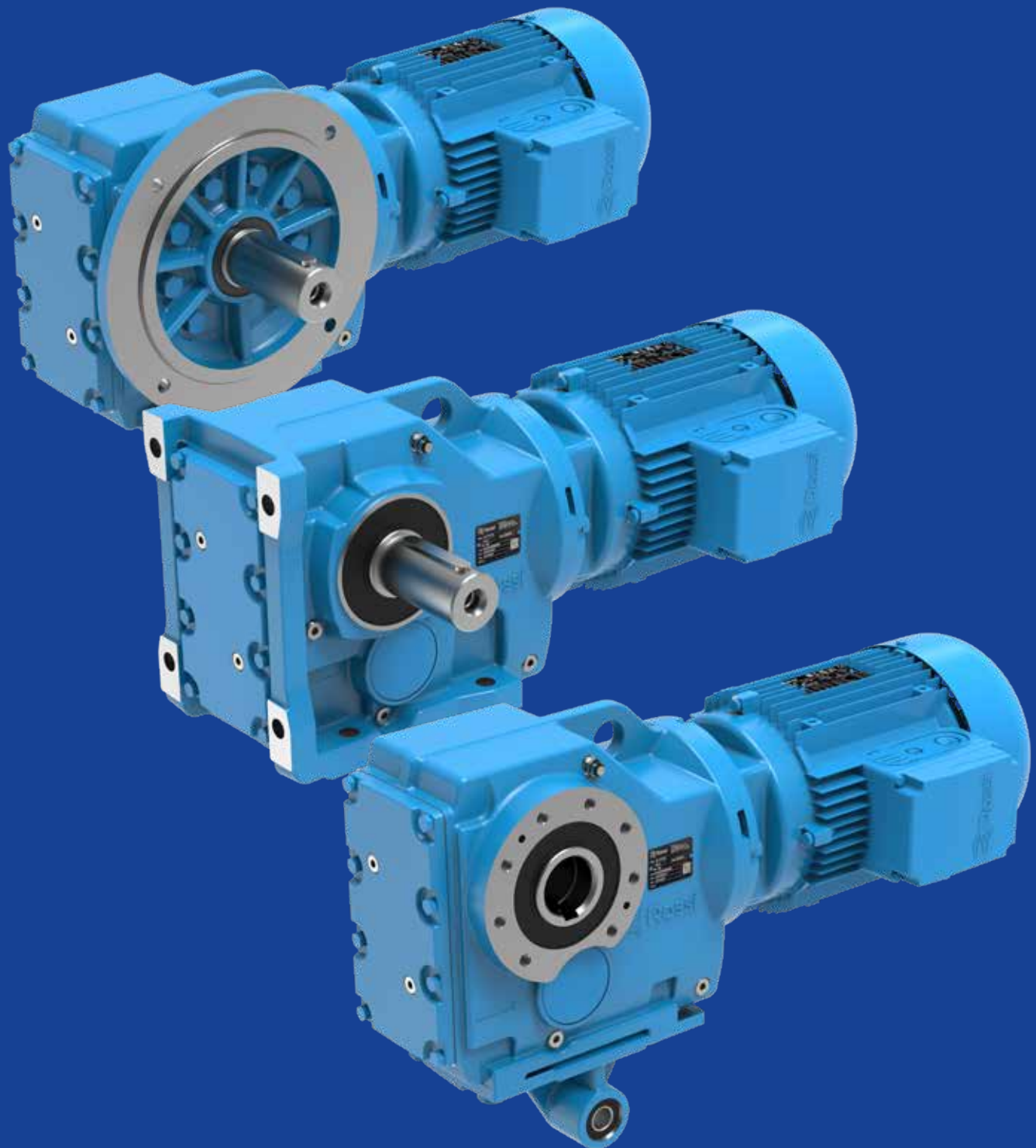

Section contents

12.1	iO 373	186
12.2	iO 473	189
12.3	iO 573	192
12.4	iO 673	195
12.5	iO 773	198
12.6	iO 873	201
12.7	iO 973	204

12.1

iO 373 PE

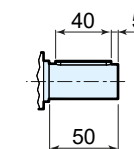
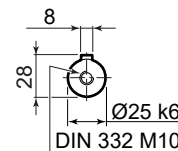
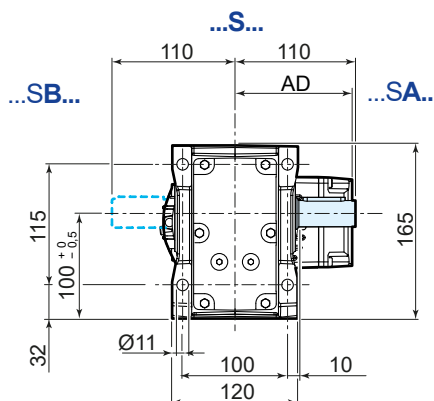
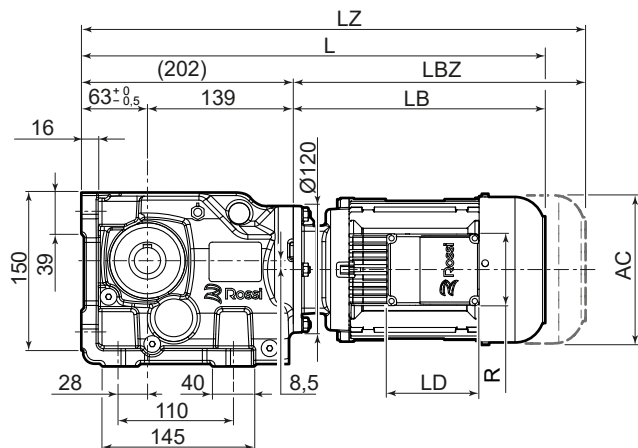
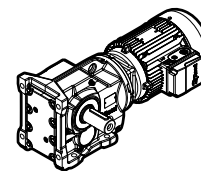

UT.C 2543

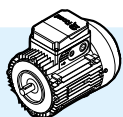
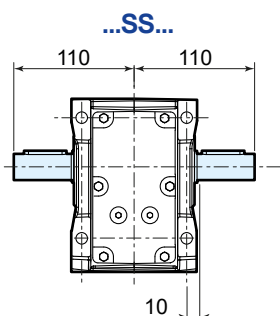

	63	71	80	90S ^{2) 3)}	90L ³⁾	100 ³⁾	112 ³⁾
AC	123	138	156	176	176	194	218
AD	95	112	121	141	141	151	163
LB	211	237	266	290	320	351	389
LBZ	266	299	335	369	399	446	488
L ¹⁾	413	439	468	492	522	553	591
LZ ¹⁾	468	501	537	571	601	648	690
LD	103	103	103	136	136	136	136
R	86	86	86	106	106	106	106

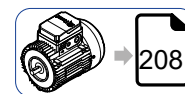
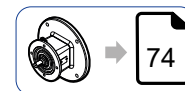

¹⁾ See also pages 80, 81

²⁾ For motors HB3-HB3Z 90S 2, HB3-HB3Z 90S 4 dimensions as motor size 90L

³⁾ The motor protrudes the gear reducer foot mounting surface

For details about drive end **A** and **B** see page 39

iO 373 FE...F316

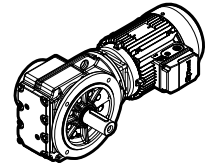

UT.C 2544

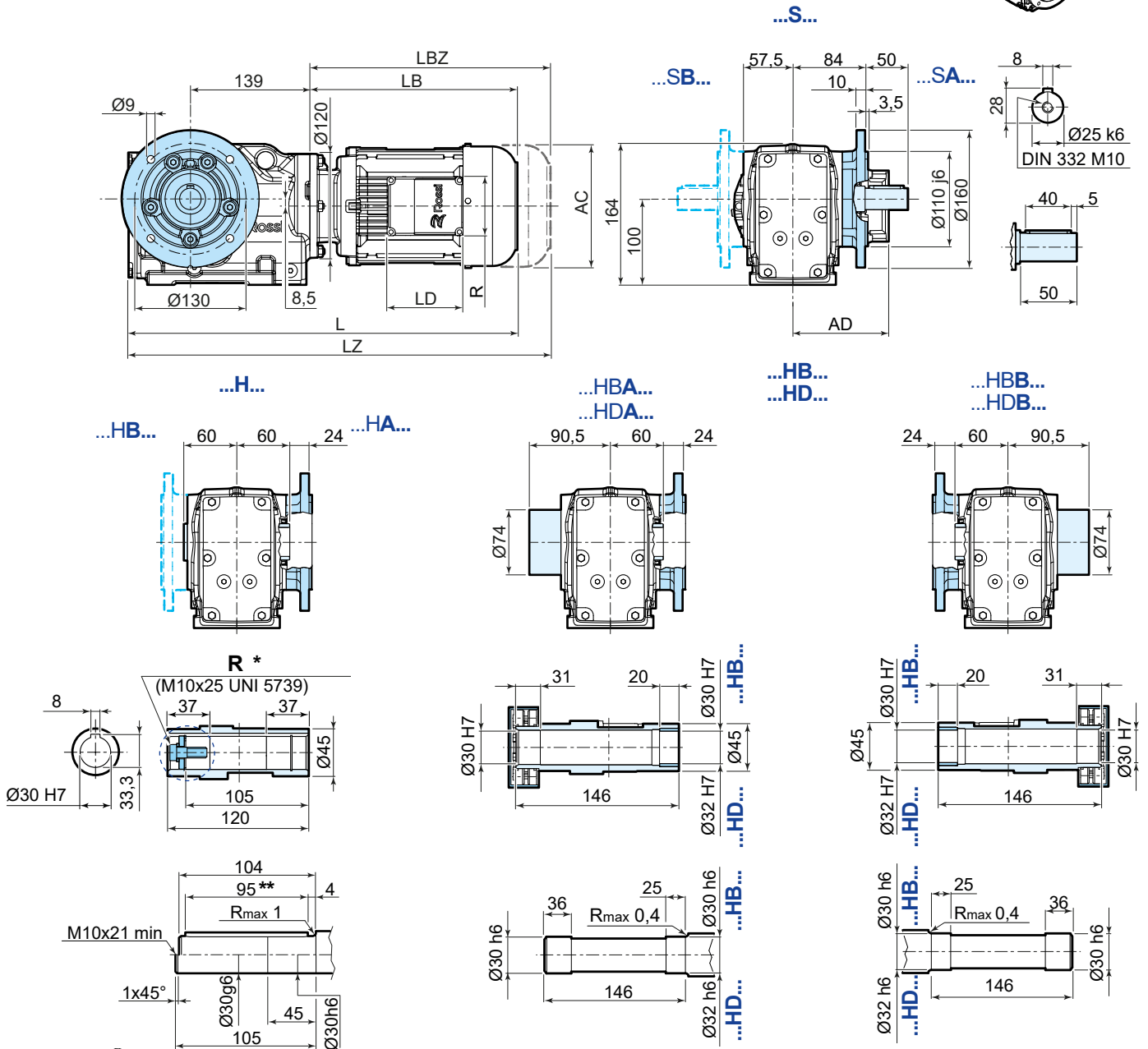

	63	71	80	90S ²⁾	90L	100	112
AC	123	138	156	176	176	194	218
AD	95	112	121	141	141	151	163
LB	211	237	266	290	320	351	389
LBZ	266	299	335	369	399	446	488
L ¹⁾	422	448	477	501	531	562	600
LZ ¹⁾	477	510	546	580	610	657	699
LD	103	103	103	136	136	136	136
R	86	86	86	106	106	106	106

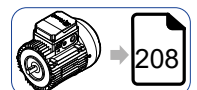
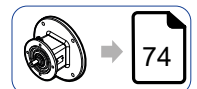
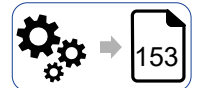

¹⁾ See also pages 80, 81

²⁾ For motors HB3-HB3Z 90S 2, HB3-HB3Z 90S 4 dimensions as motor size 90

For details about drive end **A** and **B** see page 39

^{*} options on request

^{**} both version with key

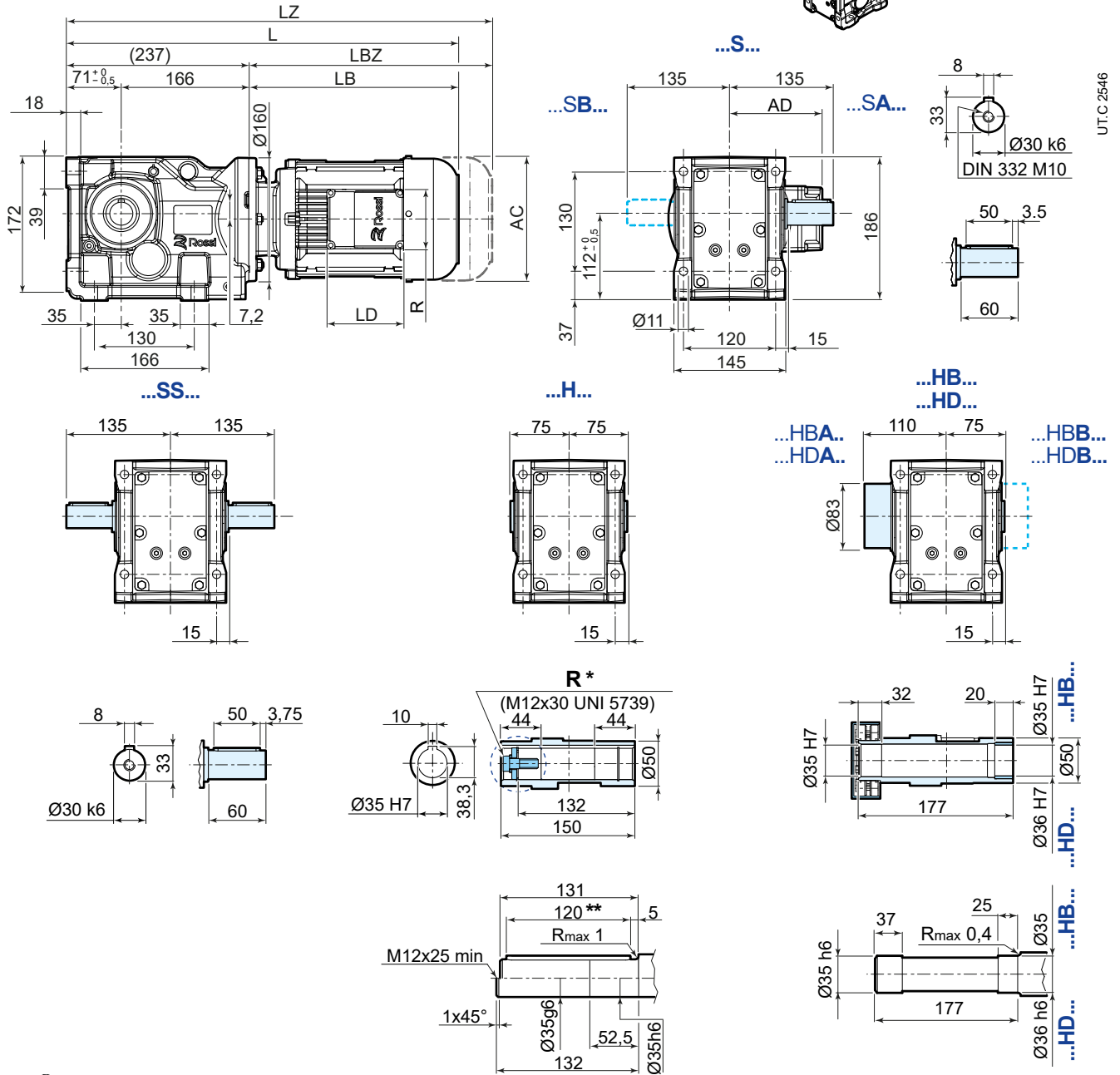
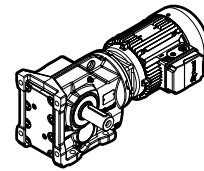

UT.C 2546

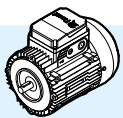

	63	71	80	90S ²⁾	90L	100	112 ³⁾
AC	123	138	156	176	176	194	218
AD	95	112	121	141	141	151	163
LB	211	237	260	290	320	351	389
LBZ	266	299	335	369	399	446	488
L ¹⁾	448	474	503	527	557	588	626
LZ ¹⁾	503	536	572	606	636	683	725
LD	103	103	103	136	136	136	136
R	86	86	86	106	106	106	106

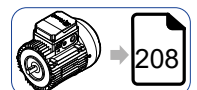
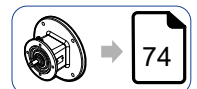
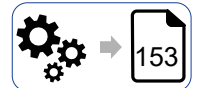

¹⁾ See also pages 80, 81

²⁾ For motors HB3-HB3Z 90S 2, HB3-HB3Z 90S 4 dimensions as motor size 90L

³⁾ The motor protrudes the gear reducer foot mounting surface

For details about drive end **A** and **B** see page 3

^{*} options on request

^{**} both version with key

iO 473 SE

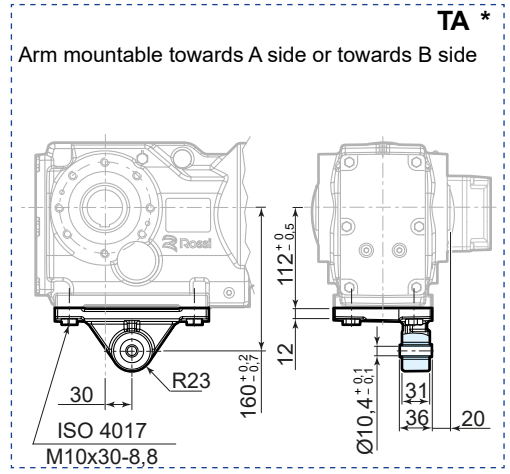
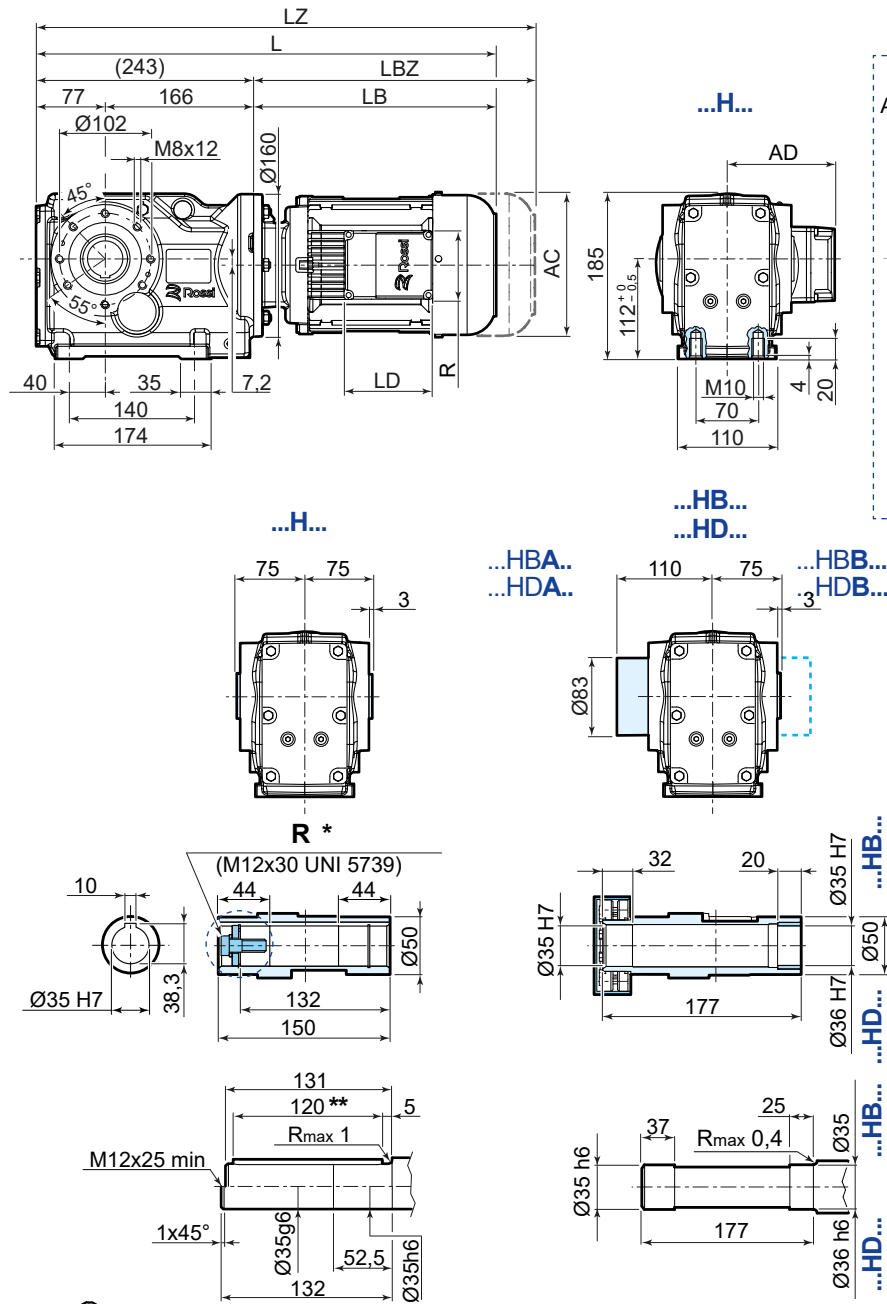
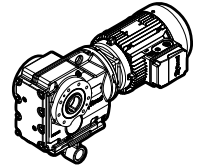

U.T.C. 25/48

	63	71	80	90S ²⁾	90L	100	112
AC	123	138	156	176	176	194	218
AD	95	112	121	141	141	151	163
LB	211	237	260	290	320	351	389
LBZ	266	299	335	369	399	446	488
L ¹⁾	454	480	509	533	563	594	632
LZ ¹⁾	509	542	578	612	642	689	731
LD	103	103	103	136	136	136	136
R	86	86	86	106	106	106	106

¹⁾ See also pages 80, 81

²⁾ For motors HB3-HB3Z 90S 2, HB3-HB3Z 90S 4 dimensions as motor size 90L

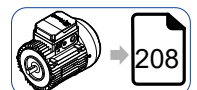
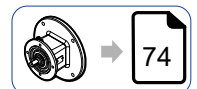
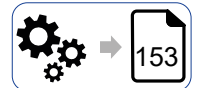

For details about drive end **A** and **B** see page 39
 * options on request
 ** both version with key

12.3

iO 573 PE

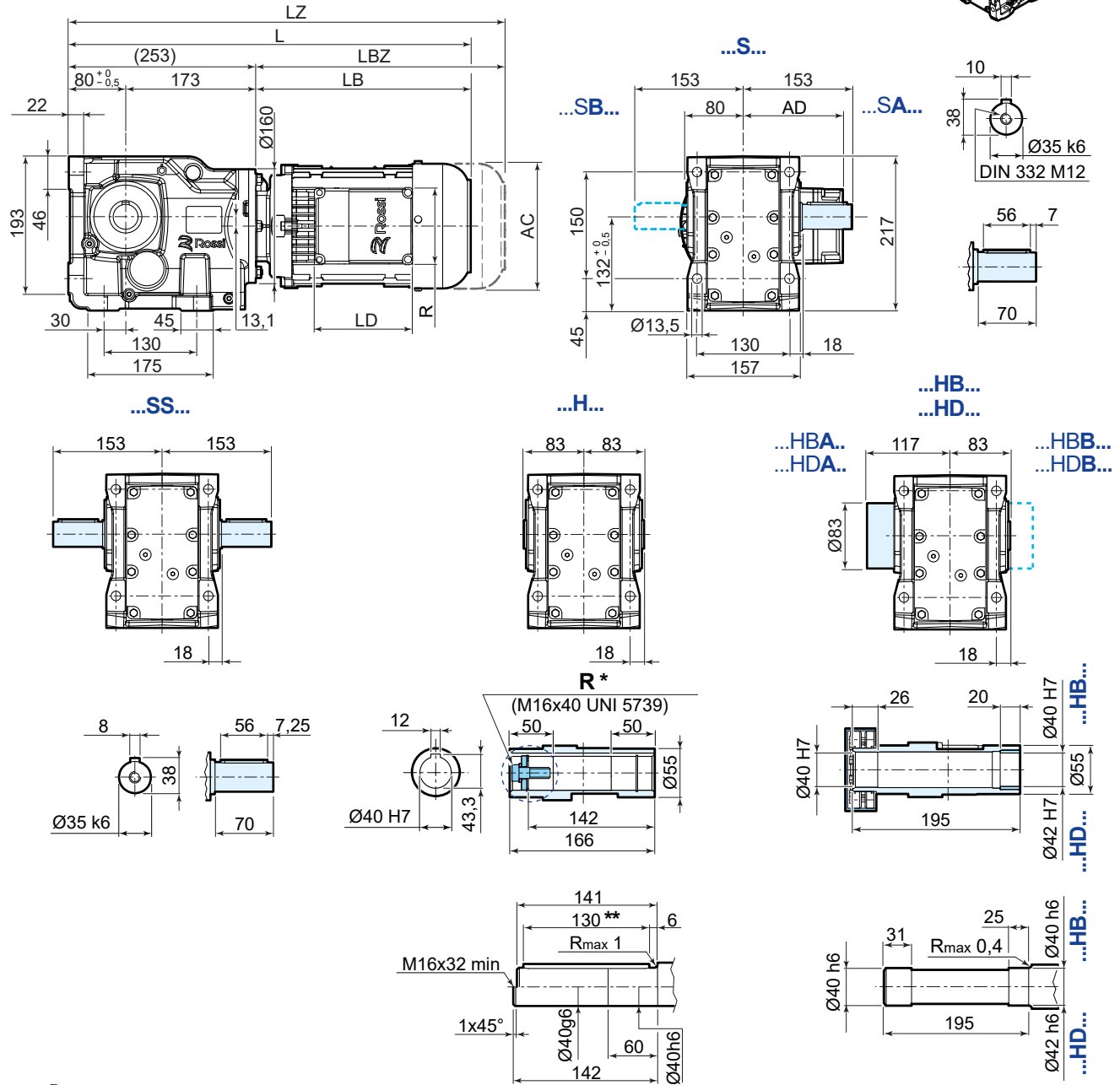
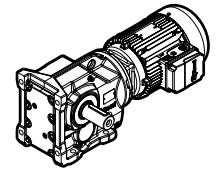

UT.C 2549

	63	71	80	90S ²⁾	90L	100	112	132S ^{3) 4)}	132M ⁴⁾
AC	123	138	156	176	176	194	218	257	257
AD	95	112	121	141	141	151	163	194	194
LB	205	231	260	283	313	345	383	439	499
LBZ	260	293	329	362	392	440	482	547	607
L ¹⁾	458	484	513	536	566	598	636	692	752
LZ ¹⁾	513	546	582	615	645	693	735	800	860
LD	103	103	103	136	136	136	136	190	190
R	86	86	86	106	106	106	106	148	148

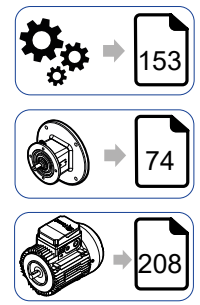

¹⁾ See also pages 80, 81
²⁾ For motors HB3-HB3Z 90S 2, HB3-HB3Z 90S 4 dimensions as motor size 90L
³⁾ For motors HB3-HB3Z 132 SB 2, HB3-HB3Z 132SC 2, HB3-HB3Z 132S 4 dimensions as motor size 132M
⁴⁾ The motor protrudes the gear reducer foot mounting surface
 For details about drive end **A** and **B** see page 39
^{*} options on request
^{**} both version with key

iO 573 SE

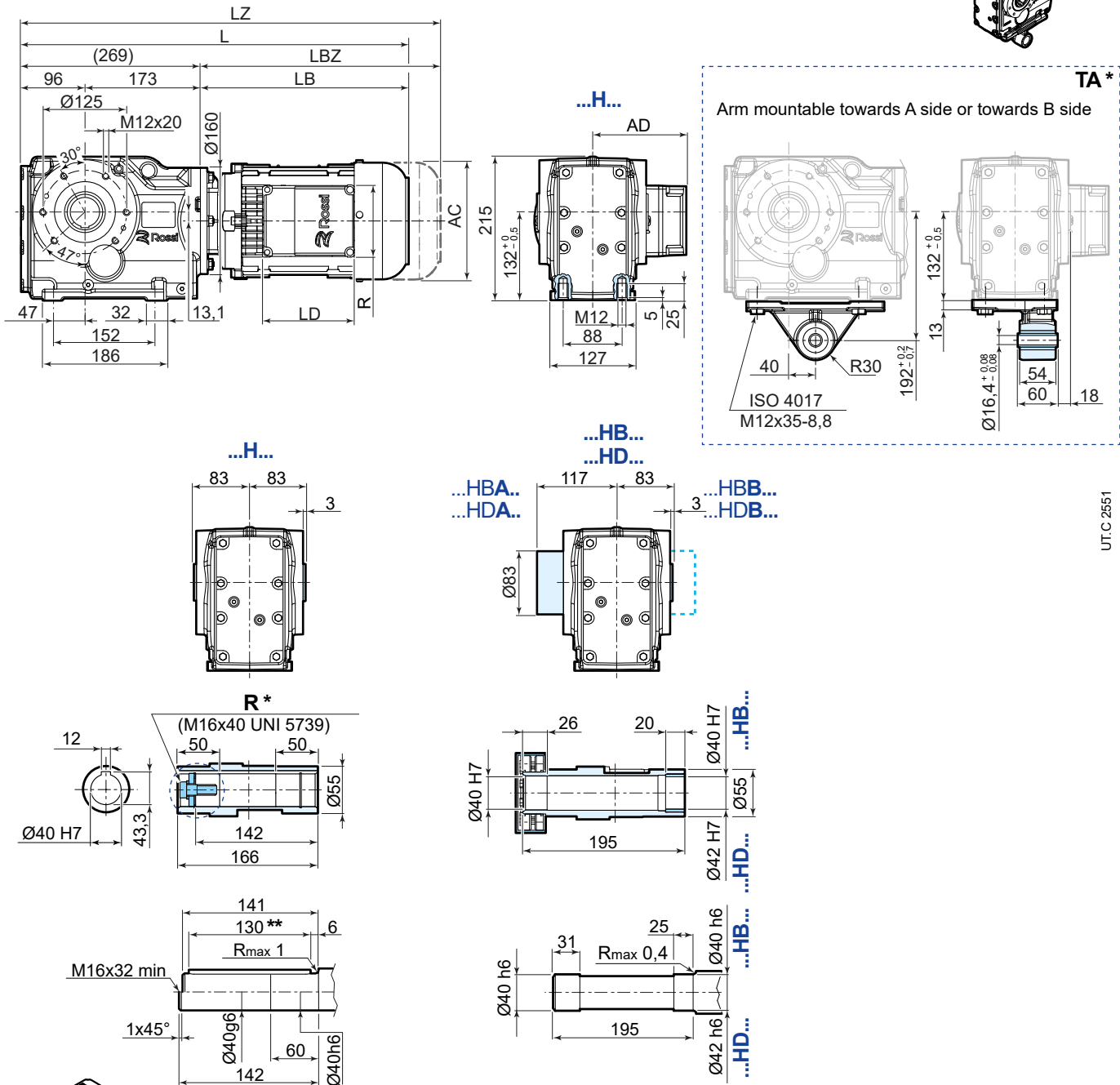
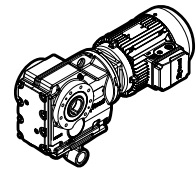

	63	71	80	90S ²⁾	90L	100	112	132S ³⁾	132M
AC	123	138	156	176	176	194	218	257	257
AD	95	112	121	141	141	151	163	194	194
LB	205	231	260	283	313	345	383	439	499
LBZ	260	293	329	362	392	440	482	547	607
L¹⁾	474	500	529	552	582	614	652	708	768
LZ¹⁾	529	562	598	631	661	709	751	816	876
LD	103	103	103	136	136	136	136	190	190
R	86	86	86	106	106	106	106	148	148

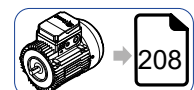
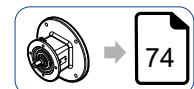
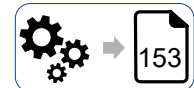

¹⁾ See also pages 80, 81

²⁾ For motors HB3-HB3Z 90S 2, HB3-HB3Z 90S 4 dimensions as motor size 90L

³⁾ For motors HB3-HB3Z 132 SB 2, HB3-HB3Z 132SC 2, HB3-HB3Z 132S 4 dimensions as motor size 132M

For details about drive end **A** and **B** see page 39

* options on request

** both version with key

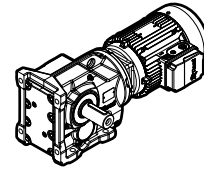

UT.C 2552

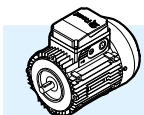
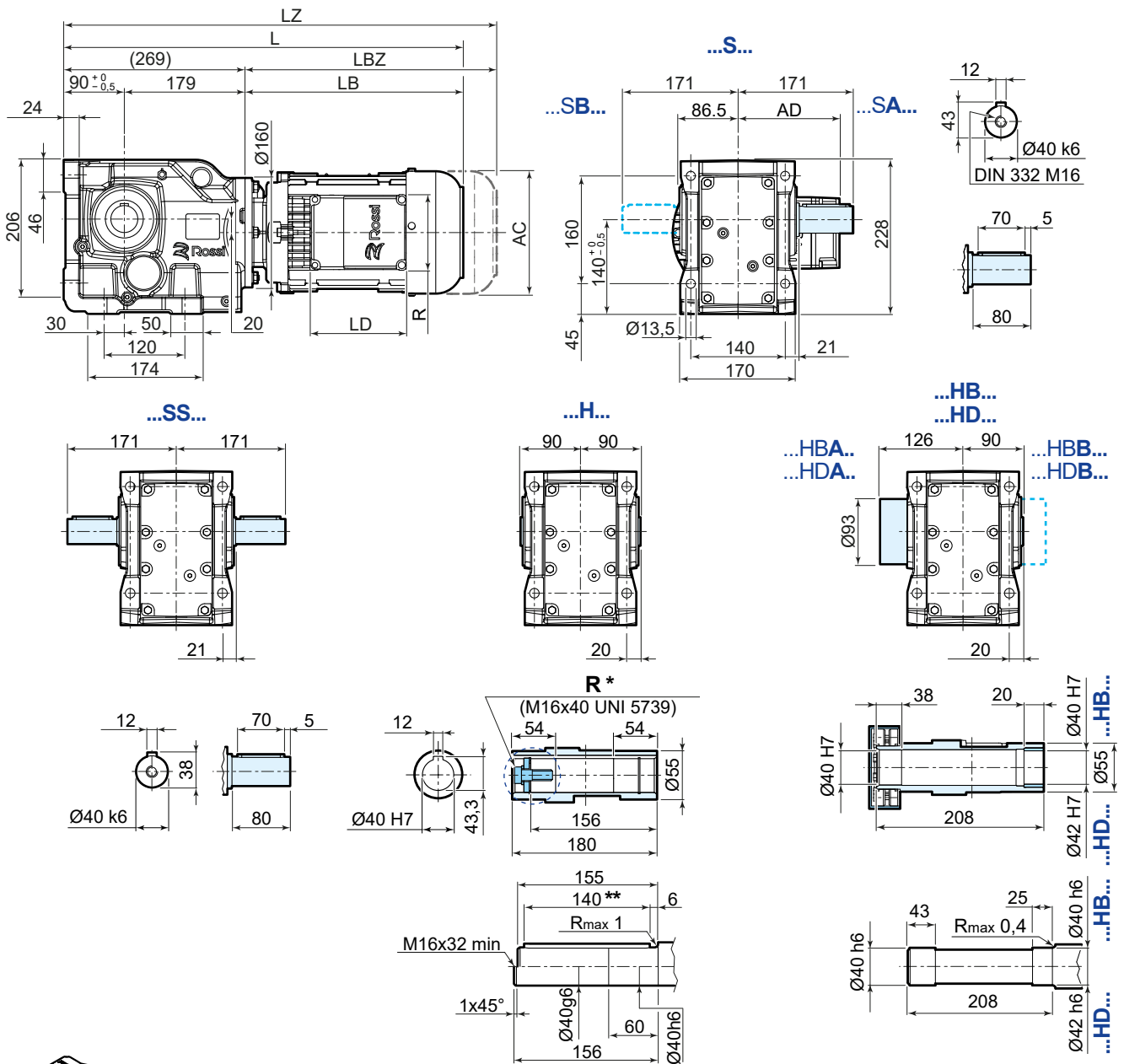

	63	71	80	90S ²⁾	90L	100	112	132S ^{3) 4)}	132M ⁴⁾
AC	123	138	156	176	176	194	218	257	257
AD	95	112	121	141	141	151	163	194	194
LB	205	231	260	283	313	345	383	439	499
LBZ	260	293	329	362	392	440	482	547	607
L ¹⁾	474	500	529	552	582	614	652	708	768
LZ ¹⁾	529	562	598	631	661	709	751	816	876
LD	103	103	103	136	136	136	136	190	190
R	86	86	86	106	106	106	106	148	148

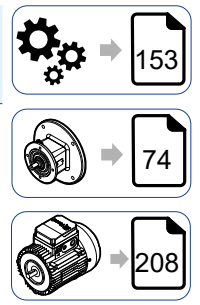

¹⁾ See also pages 80, 81

²⁾ For motors HB3-HB3Z 90S 2, HB3-HB3Z 90S 4 dimensions as motor size 90L

³⁾ For motors HB3-HB3Z 132 SB 2, HB3-HB3Z 132SC 2, HB3-HB3Z 132S 4 dimensions as motor size 132M

⁴⁾ The motor protrudes the gear reducer foot mounting surface

For details about drive end **A** and **B** see page 39

^{*} options on request

^{**} both version with key

iO 673 FE...F625

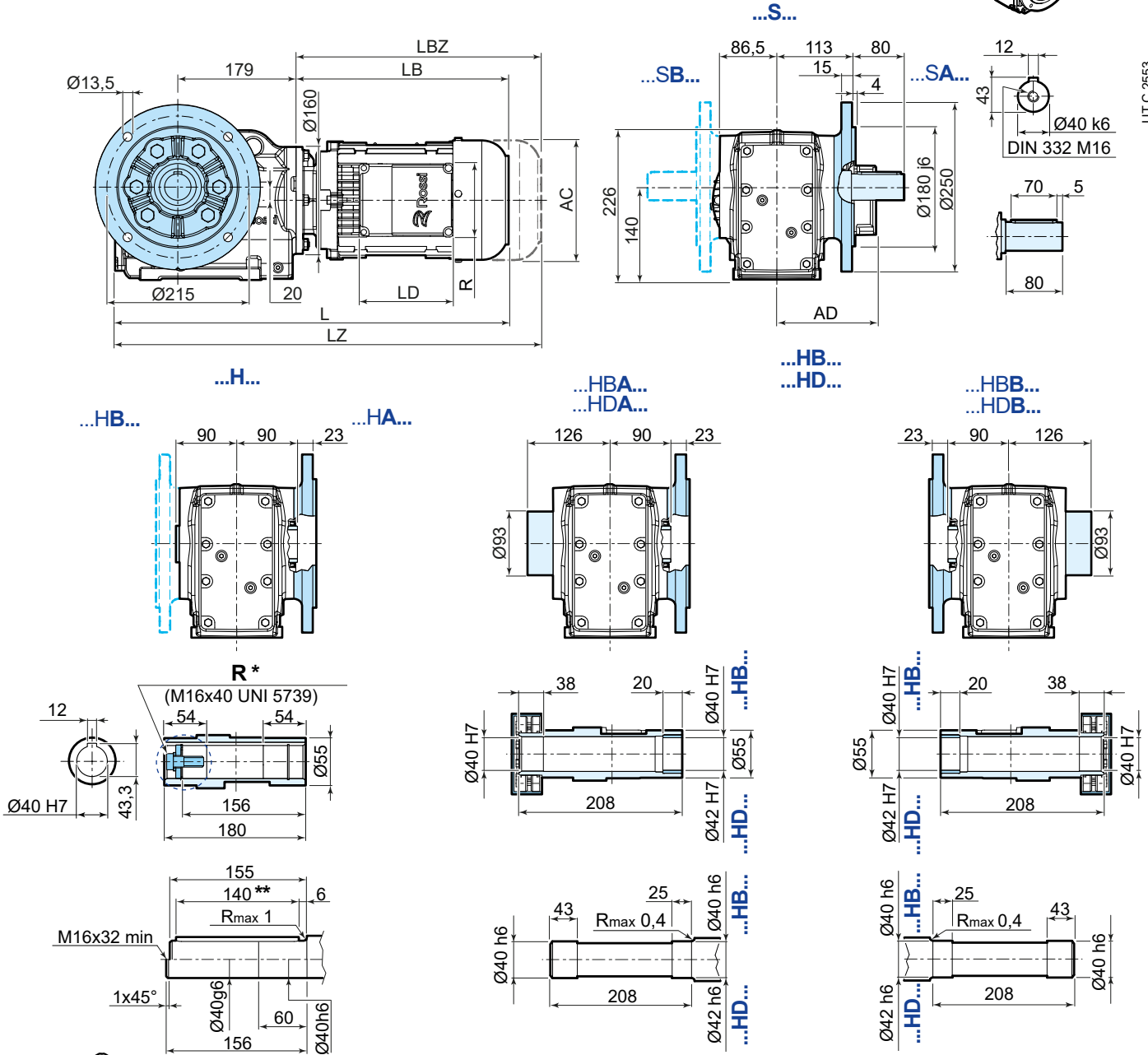
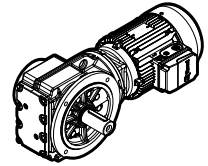

UT.C 2553

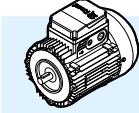

	63	71	80	90S ²⁾	90L	100	112	132S ³⁾	132M
AC	123	138	156	176	176	194	218	257	257
AD	95	112	121	141	141	151	163	194	194
LB	205	231	260	283	313	345	383	439	499
LBZ	260	293	329	362	392	440	482	547	607
L ¹⁾	479	505	534	557	587	619	657	713	773
LZ ¹⁾	534	567	603	636	666	714	756	821	881
LD	103	103	103	136	136	136	136	190	190
R	86	86	86	106	106	106	106	148	148

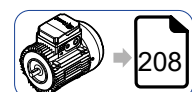
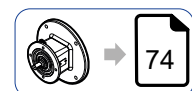
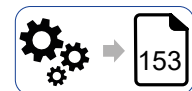

¹⁾ See also pages 80, 81
²⁾ For motors HB3-HB3Z 90S 2, HB3-HB3Z 90S 4 dimensions as motor size 90L
³⁾ For motors HB3-HB3Z 132 SB 2, HB3-HB3Z 132SC 2, HB3-HB3Z 132S 4 dimensions as motor size 132M

For details about drive end **A** and **B** see page 39
^{*} options on request
^{**} both version with key

iO

iO 673 SE

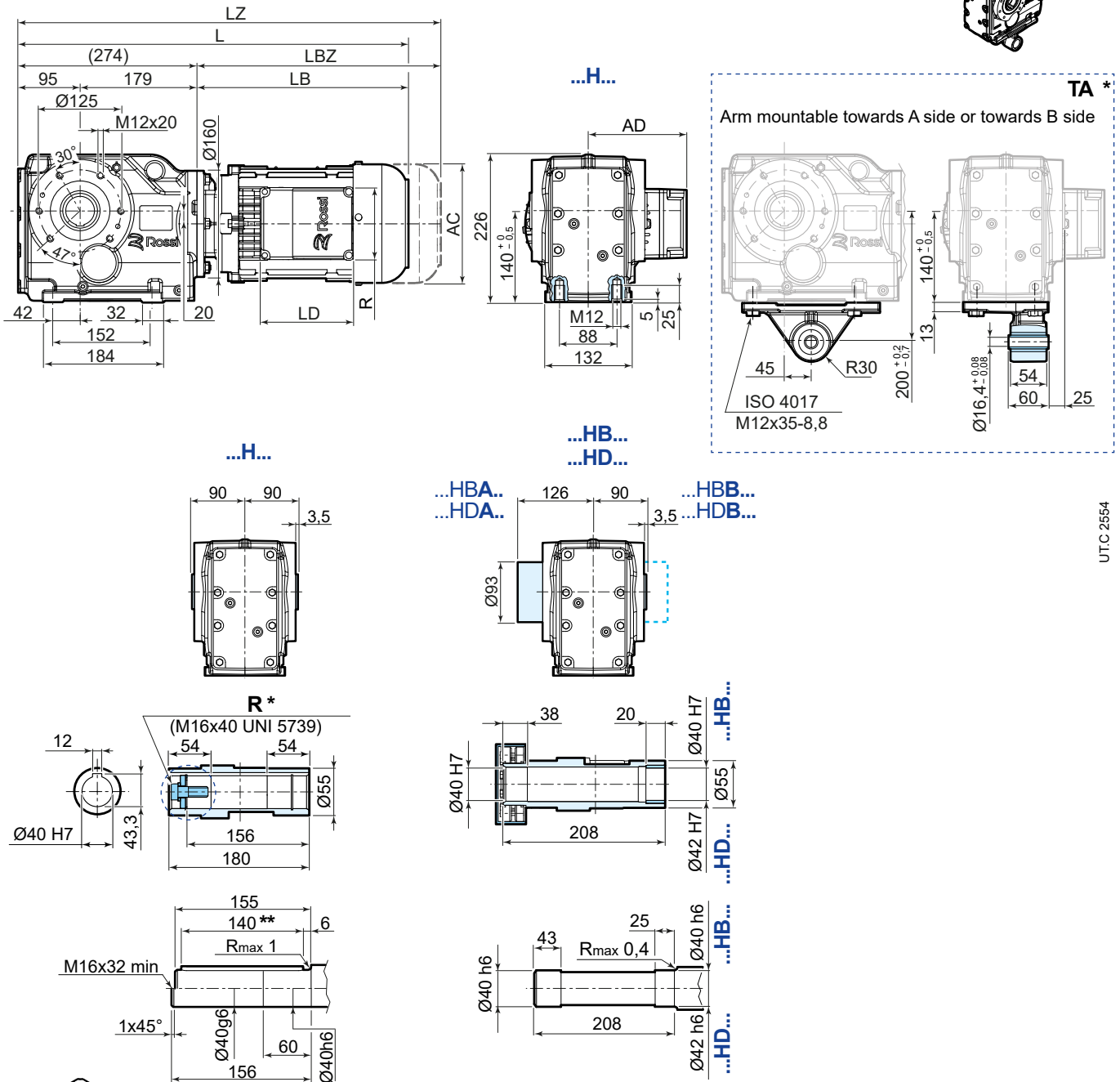
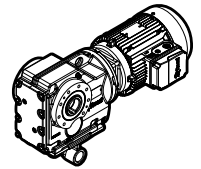

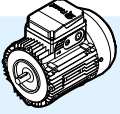
	63	71	80	90S ²⁾	90L	100	112	132S ³⁾	132M
									
AC	123	138	156	176	176	194	218	257	257
AD	95	112	121	141	141	151	163	194	194
LB	205	231	260	283	313	345	383	439	499
LBZ	260	293	329	362	392	440	482	547	607
L ¹⁾	479	505	534	557	587	619	657	713	773
LZ ¹⁾	534	567	603	636	666	714	756	821	881
LD	103	103	103	136	136	136	136	190	190
R	86	86	86	106	106	106	106	148	148

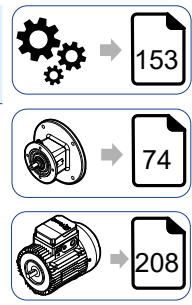

¹⁾ See also pages 80, 81

²⁾ For motors HB3-HB3Z 90S 2, HB3-HB3Z 90S 4 dimensions as motor size 90L

³⁾ For motors HB3-HB3Z 132 SB 2, HB3-HB3Z 132SC 2, HB3-HB3Z 132S 4 dimensions as motor size 132M

For details about drive end **A** and **B** see page 3
* options on request.

** both version with key

12.5

iO 773 PE

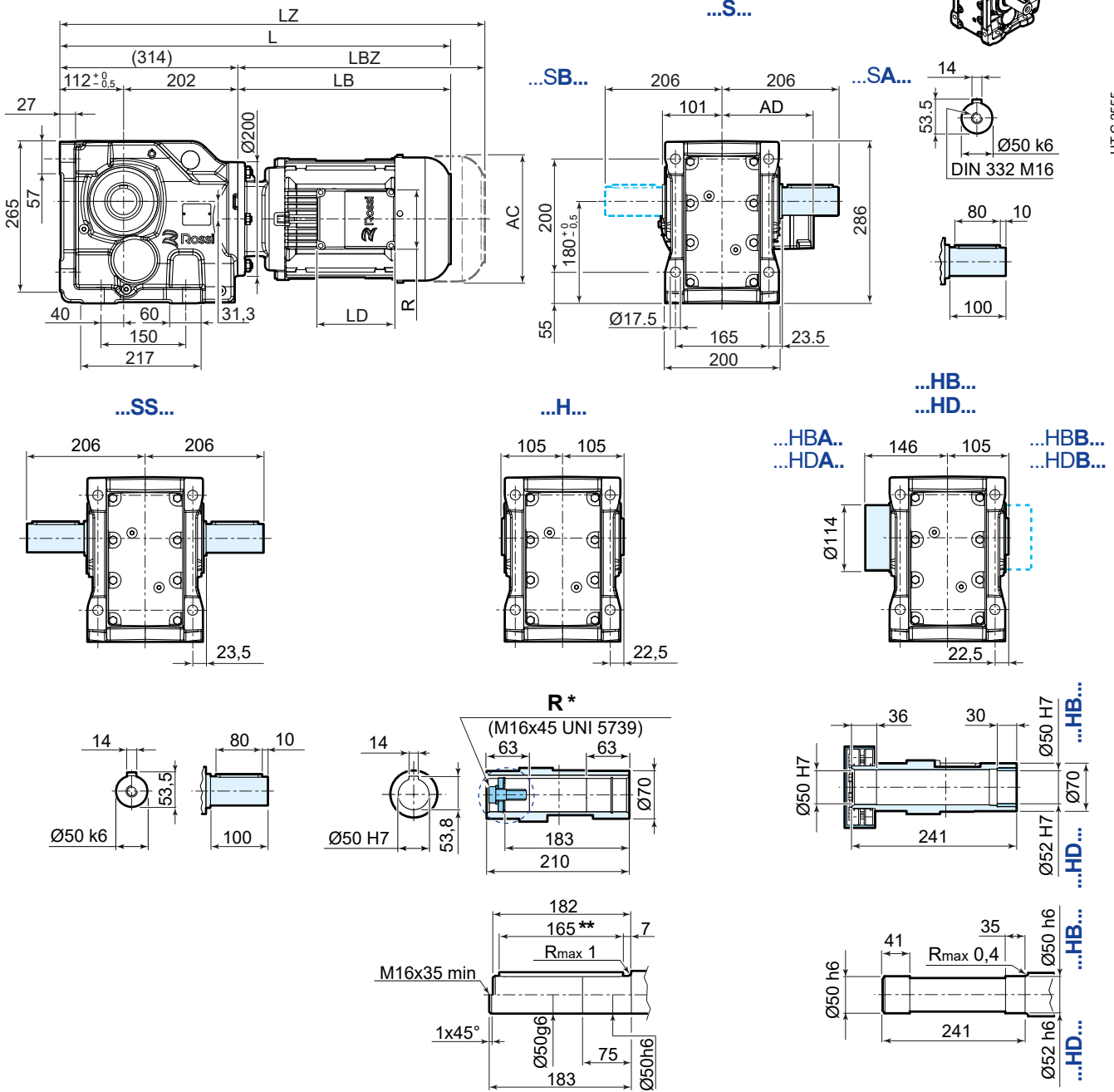
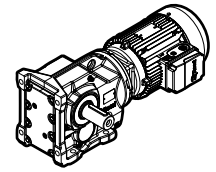

UT.C 2555

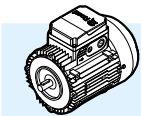

	63	71	80	90S ²⁾	90L	100	112	132S ³⁾	132M
AC	123	138	156	176	176	194	218	257	257
AD	95	112	121	141	141	151	163	194	194
LB	199	225	254	276	306	339	377	433	493
LBZ	254	287	323	355	385	434	476	541	601
L ¹⁾	513	539	568	590	620	653	691	747	807
LZ ¹⁾	568	601	637	669	699	748	790	855	915
LD	103	103	103	136	136	136	136	190	190
R	86	86	86	106	106	106	106	148	148

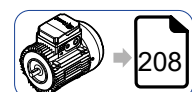
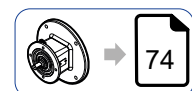
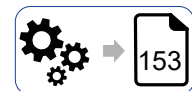

¹⁾ See also pages 80, 81
²⁾ For motors HB3-HB3Z 90S 2, HB3-HB3Z 90S 4 dimensions as motor size 90L
³⁾ For motors HB3-HB3Z 132 SB 2, HB3-HB3Z 132SC 2, HB3-HB3Z 132S 4 dimensions as motor size 132M
 For details about drive end **A** and **B** see page 39
^{*} options on request
^{**} both version with key

iO

iO 773 FE...F730

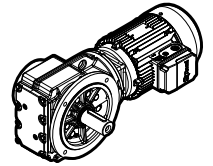

UT.C 2556

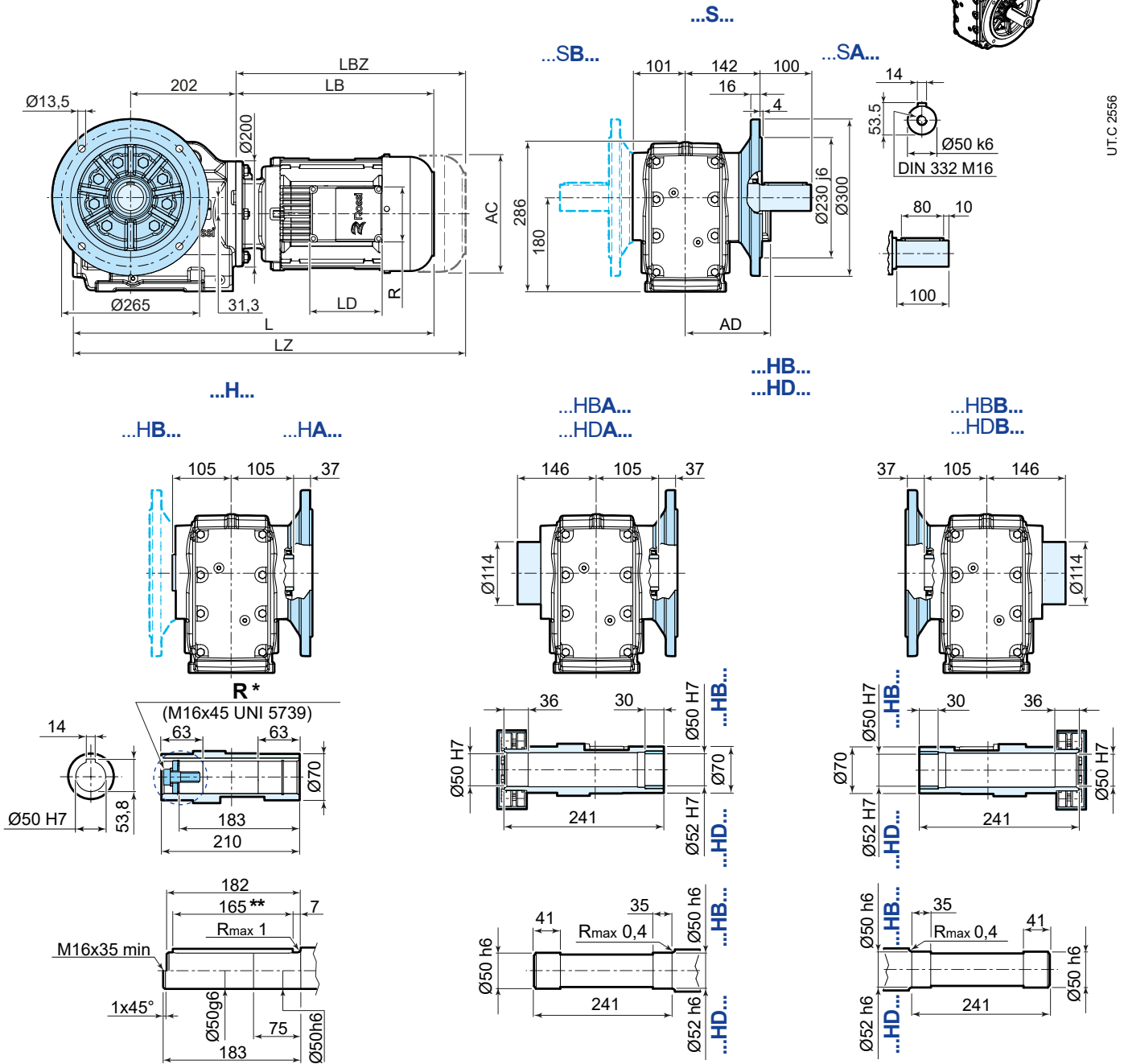

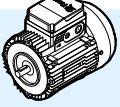
	63	71	80	90S ²⁾	90L	100	112	132S ³⁾	132M
									
AC	123	138	156	176	176	194	218	257	257
AD	95	112	121	141	141	151	163	194	194
LB	199	225	254	276	306	339	377	433	493
LBZ	254	287	323	355	385	434	476	541	601
L ¹⁾	511	537	566	588	618	651	689	745	805
LZ ¹⁾	566	599	635	667	697	746	788	853	913
LD	103	103	103	136	136	136	136	190	190
R	86	86	86	106	106	106	106	148	148

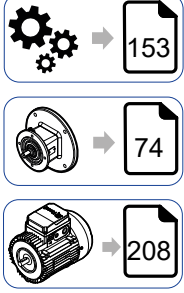

¹⁾ See also pages 80, 81

²⁾ For motors HB3-HB3Z 90S 2, HB3-HB3Z 90S 4 dimensions as motor size 90L

³⁾ For motors HB3-HB3Z 132 SB 2, HB3-HB3Z 132SC 2, HB3-HB3Z 132S 4 dimensions as motor size 132M

For details about drive end **A** and **B** see page 39

^{*} options on request

^{**} both version with key

iO 773 SE

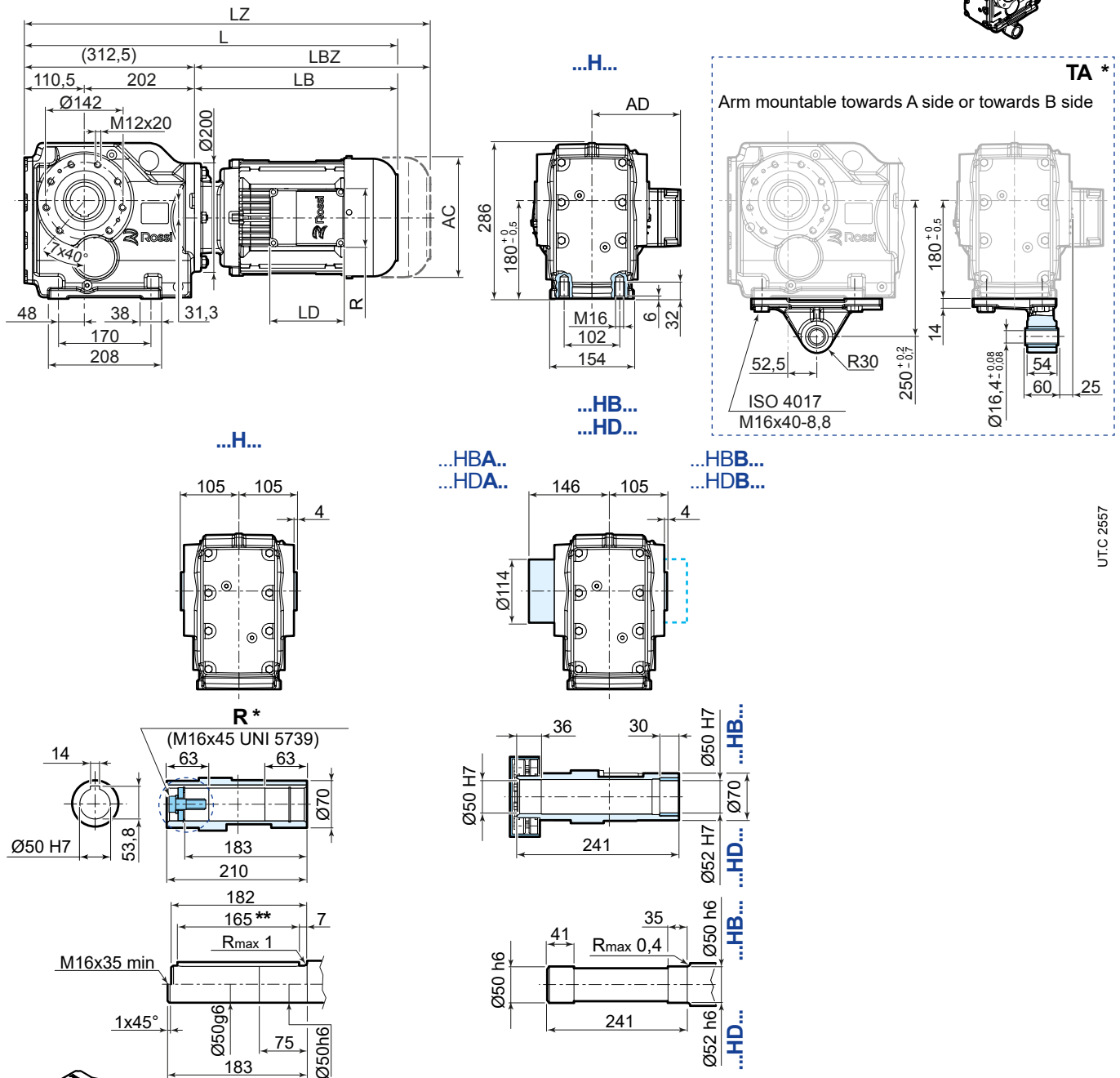
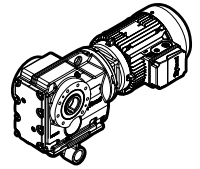

UTC 2557

	63	71	80	90S ²⁾	90L	100	112	132S ³⁾	132M
AC	123	138	156	176	176	194	218	257	257
AD	95	112	121	141	141	151	163	194	194
LB	199	225	254	276	306	339	377	433	493
LBZ	254	287	323	355	385	434	476	541	601
L ¹⁾	513	539	568	590	620	653	691	747	807
LZ ¹⁾	568	601	637	669	699	748	790	855	915
LD	103	103	103	136	136	136	136	190	190
R	86	86	86	106	106	106	106	148	148

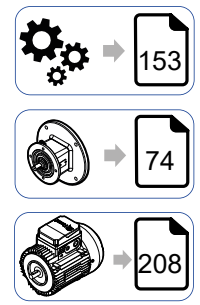

¹⁾ See also pages 80, 81

²⁾ For motors HB3-HB3Z 90S 2, HB3-HB3Z 90S 4 dimensions as motor size 90L

³⁾ For motors HB3-HB3Z 132 SB 2, HB3-HB3Z 132SC 2, HB3-HB3Z 132S 4 dimensions as motor size 132M

For details about drive end **A** and **B** see page 39

^{*} options on request

^{**} both version with key

12.6 iO 873 PE

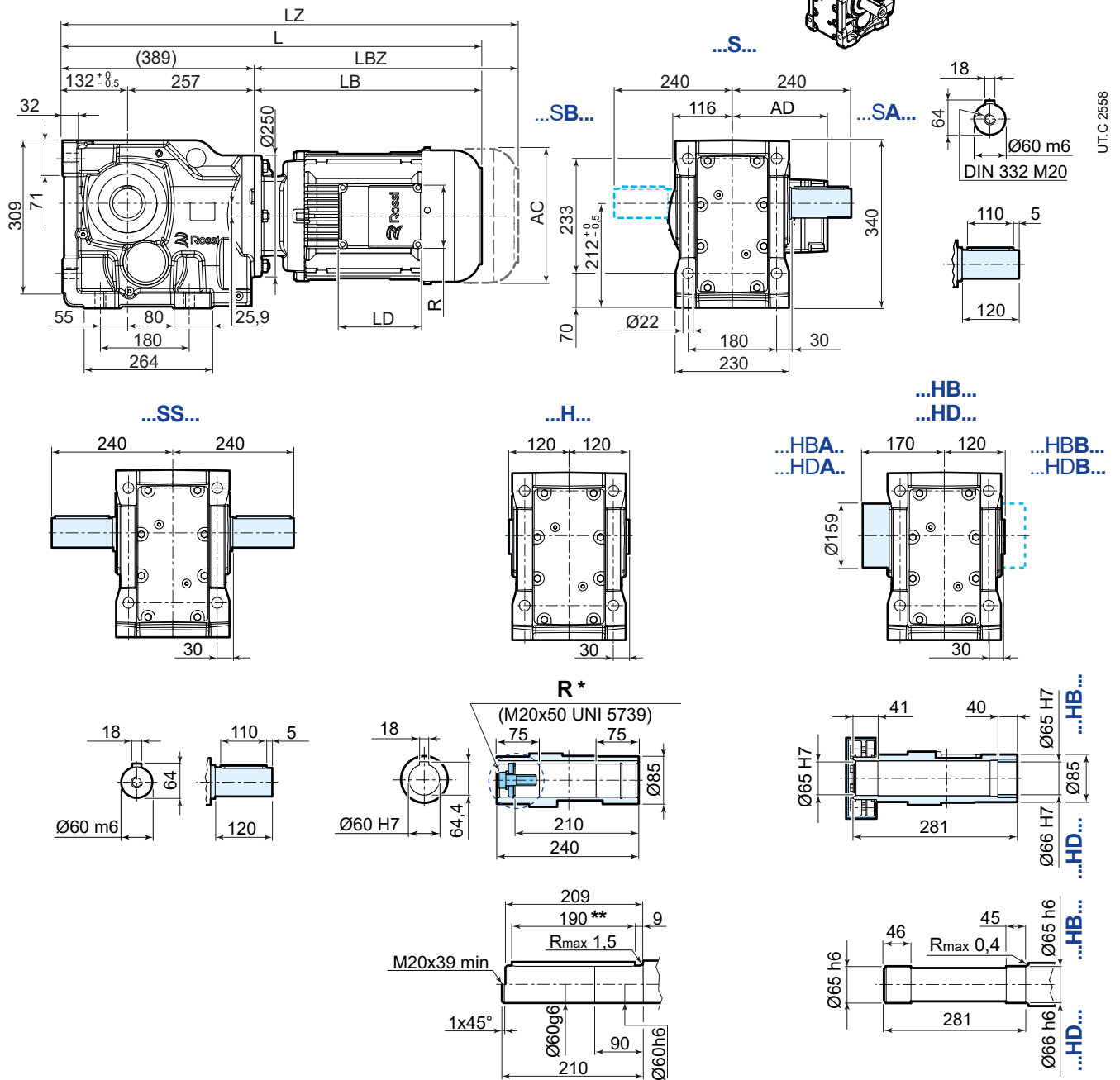
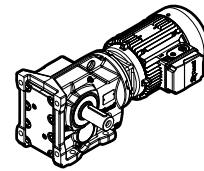

UT.C 2558

	80	90S ²⁾	90L	100	112	132S ³⁾	132M
AC	156	176	176	194	218	257	257
AD	121	141	141	151	163	194	194
LB	254	276	306	339	377	433	493
LBZ	323	355	385	434	476	541	601
L ¹⁾	643	665	695	728	766	822	882
LZ ¹⁾	712	744	774	823	865	930	990
LD	103	136	136	136	136	190	190
R	86	106	106	106	106	148	148

¹⁾ See also pages 80, 81

²⁾ For motors HB3-HB3Z 90S 2, HB3-HB3Z 90S 4 dimensions as motor size 90L

³⁾ For motors HB3-HB3Z 132 SB 2, HB3-HB3Z 132SC 2, HB3-HB3Z 132S 4 dimensions as motor size 132M

For details about drive end **A** and **B** see page 39

* options on request

** both version with key

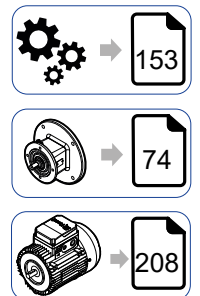

iO 873 SE

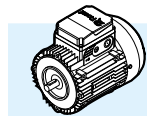
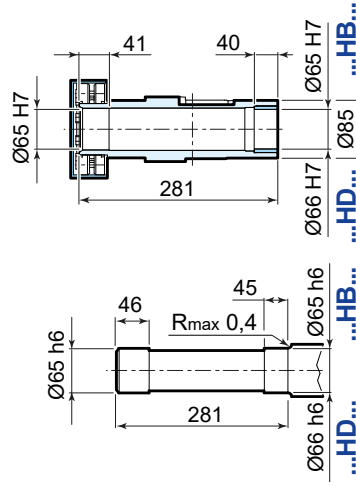
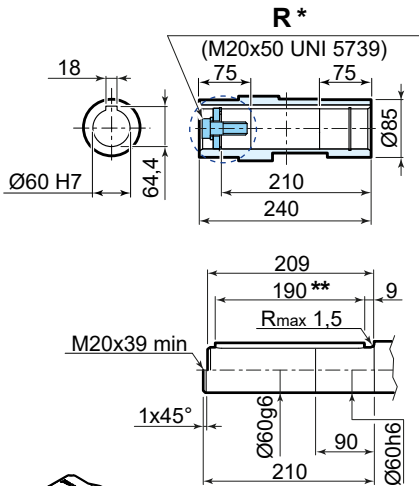
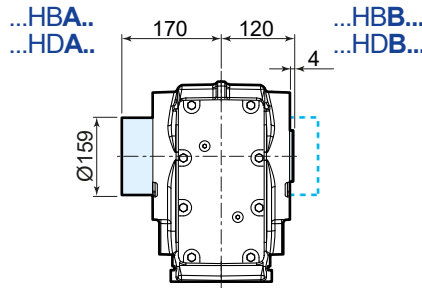
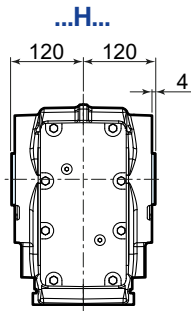
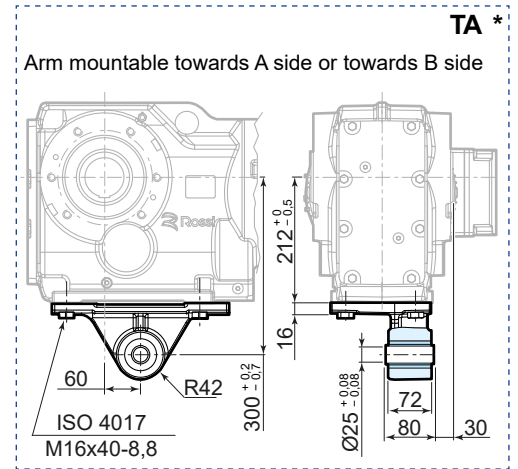
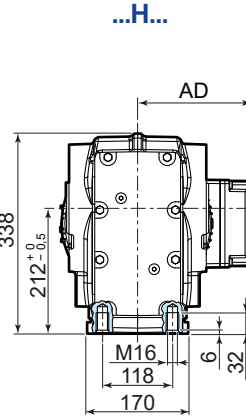
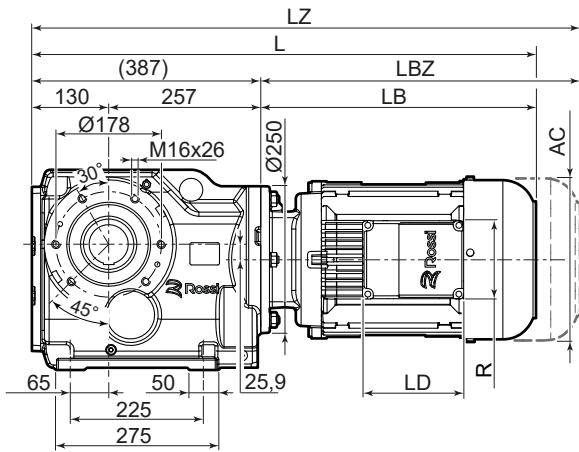
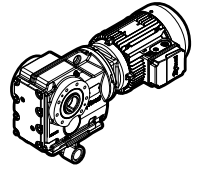

	80	90S ²⁾	90L	100	112	132S ³⁾	132M
AC	156	176	176	194	218	257	257
AD	121	141	141	151	163	194	194
LB	254	276	306	339	377	433	493
LBZ	323	355	385	434	476	541	601
L ¹⁾	641	663	693	726	764	820	880
LZ ¹⁾	710	742	772	821	863	928	988
LD	103	136	136	136	136	190	190
R	86	106	106	106	106	148	148

¹⁾ See also pages 80, 81

²⁾ For motors HB3-HB3Z 90S 2, HB3-HB3Z 90S 4 dimensions as motor size 90L

³⁾ For motors HB3-HB3Z 132 SB 2, HB3-HB3Z 132SC 2, HB3-HB3Z 132S 4 dimensions as motor size 132M

For details about drive end **A** and **B** see page 39

* options on request

** both version with key

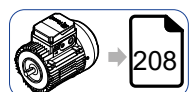
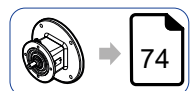
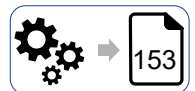

12.7

iO 973 PE

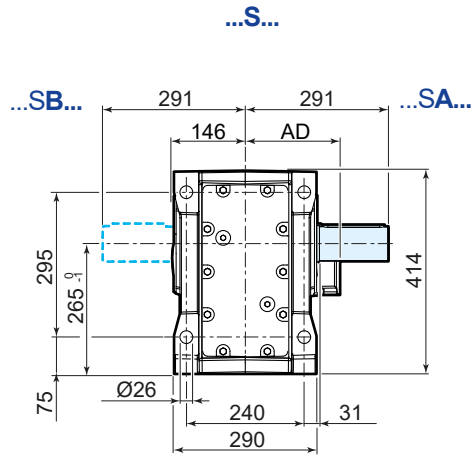
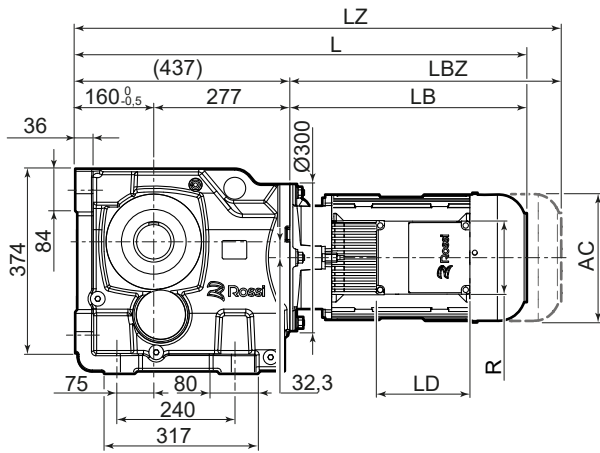
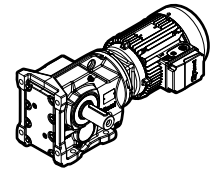

UT.C 2561

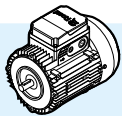
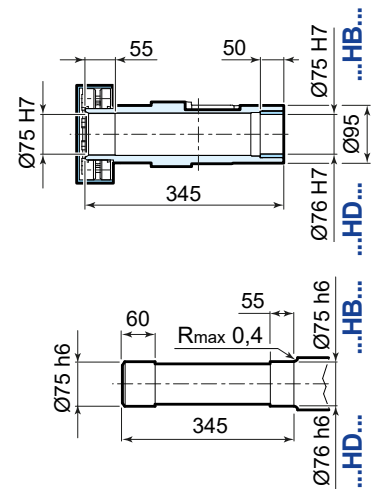
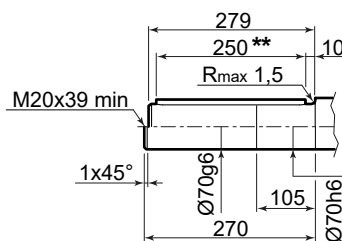
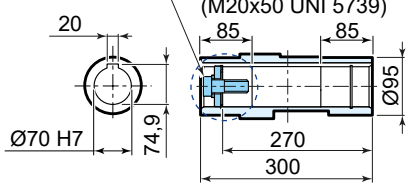
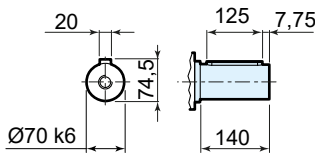
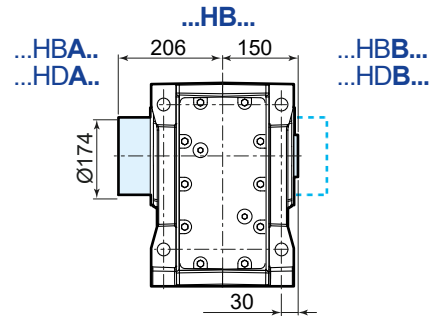
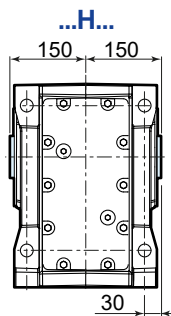
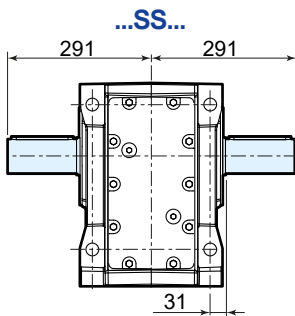

	80	90S ²⁾	90L	100	112	132S ³⁾	132M
AC	156	176	176	194	218	257	257
AD	121	141	141	151	163	194	194
LB	254	276	306	339	377	433	493
LBZ	323	355	385	434	476	541	601
L ¹⁾	691	713	743	776	814	870	930
LZ ¹⁾	760	792	822	871	913	978	1038
LD	103	136	136	136	136	190	190
R	86	106	106	106	106	148	148

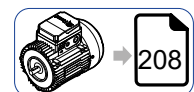
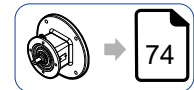
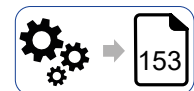

¹⁾ See also pages 80, 81

²⁾ For motors HB3-HB3Z 90S 2, HB3-HB3Z 90S 4 dimensions as motor size 90L

³⁾ For motors HB3-HB3Z 132 SB 2, HB3-HB3Z 132SC 2, HB3-HB3Z 132S 4 dimensions as motor size 132M

For details about drive end **A** and **B** see page 39

^{*} options on request

^{**} both version with key

iO 973 FE...F945

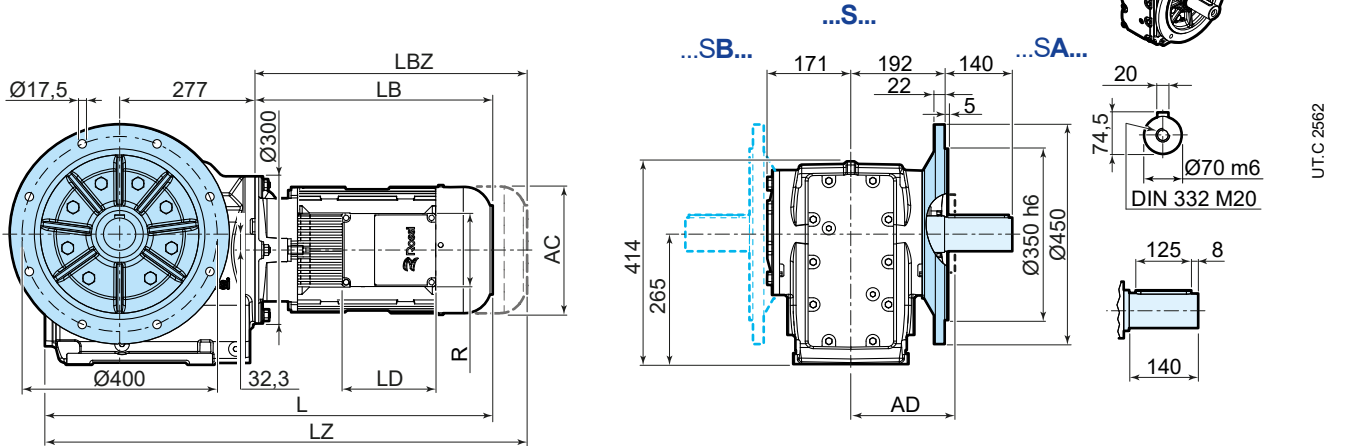
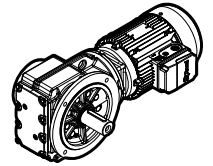

UT.C 2562

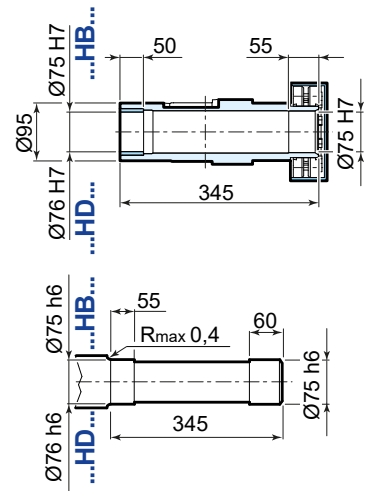
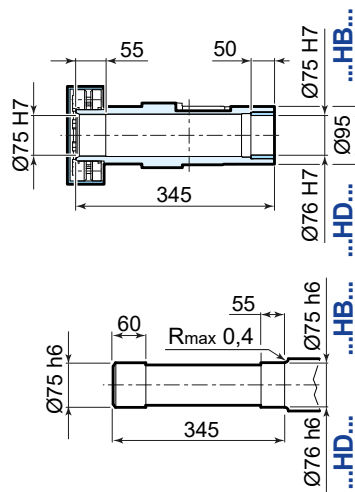
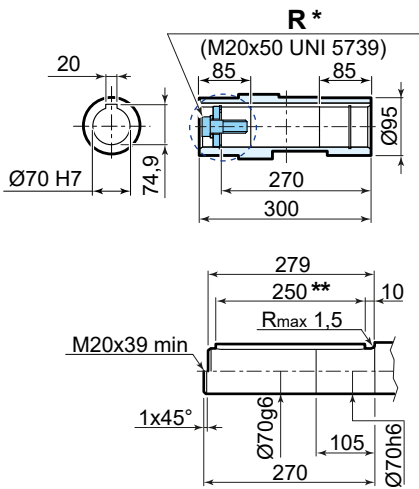
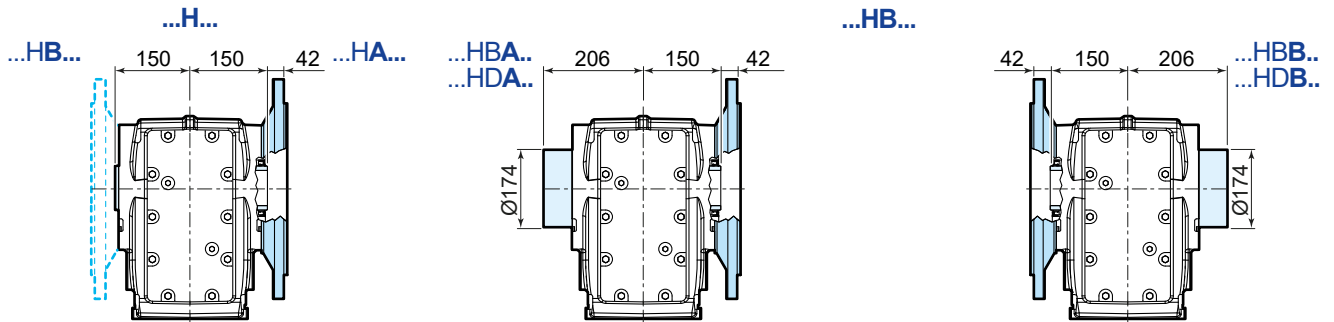

	80	90S ²⁾	90L	100	112	132S ³⁾	132M
AC	156	176	176	194	218	257	257
AD	121	141	141	151	163	194	194
LB	254	276	306	339	377	433	493
LBZ	323	355	385	434	476	541	601
L ¹⁾	684	706	736	769	807	863	923
LZ ¹⁾	753	785	815	864	906	971	1031
LD	103	136	136	136	136	190	190
R	86	106	106	106	106	148	148

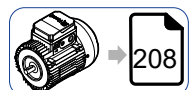
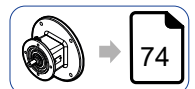
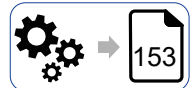

¹⁾ See also pages 80, 81

²⁾ For motors HB3-HB3Z 90S 2, HB3-HB3Z 90S 4 dimensions as motor size 90L

³⁾ For motors HB3-HB3Z 132 SB 2, HB3-HB3Z 132SC 2, HB3-HB3Z 132S 4 dimensions as motor size 132M

For details about drive end **A** and **B** see page 39

^{*} options on request

^{**} both version with key

iO 973 SE

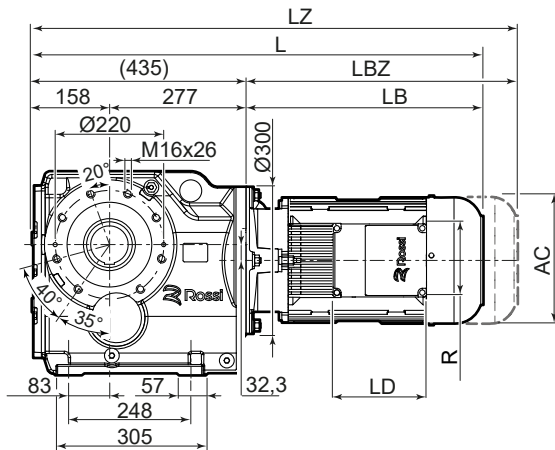
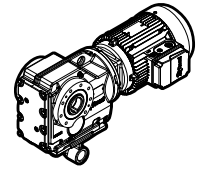

...H...

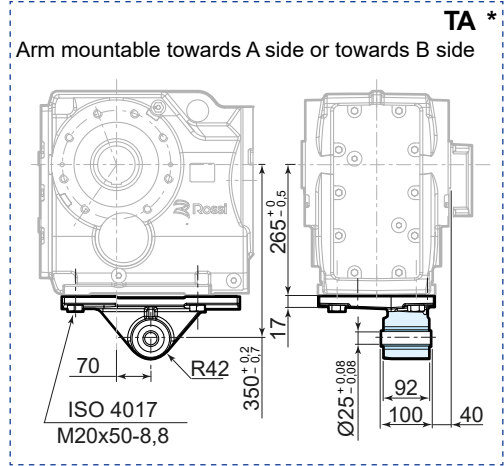
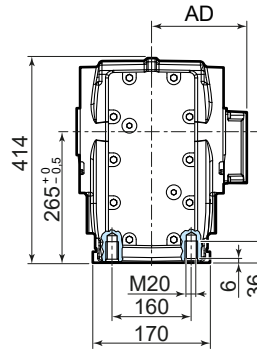

...H...

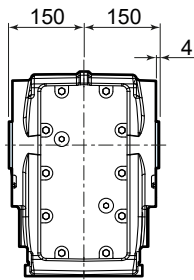

...HB...

...HBA...
...HDA...

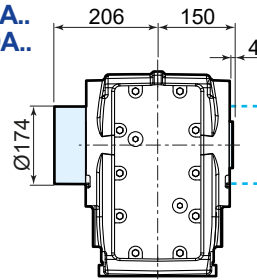

...HBB...
...HDB...

R *

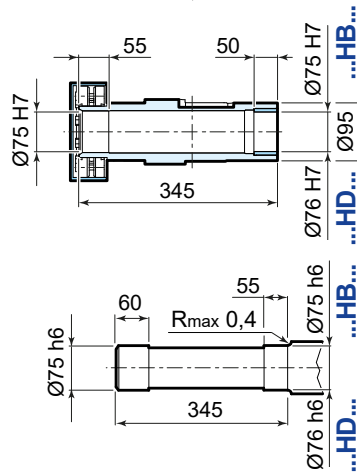
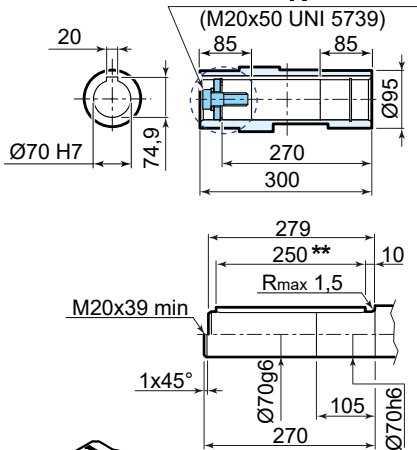

UT.C 2563

	80	90S ²⁾	90L	100	112	132S ³⁾	132M
AC	156	176	176	194	218	257	257
AD	121	141	141	151	163	194	194
LB	254	276	306	339	377	433	493
LBZ	323	355	385	434	476	541	601
L ¹⁾	689	711	741	774	812	868	928
LZ ¹⁾	758	790	820	869	911	976	1036
LD	103	136	136	136	136	190	190
R	86	106	106	106	106	148	148

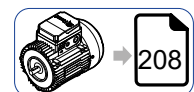
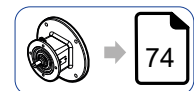
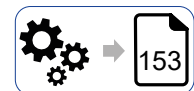

¹⁾ See also pages 80, 81

²⁾ For motors HB3-HB3Z 90S 2, HB3-HB3Z 90S 4 dimensions as motor size 90L

³⁾ For motors HB3-HB3Z 132 SB 2, HB3-HB3Z 132SC 2, HB3-HB3Z 132S 4 dimensions as motor size 132M

For details about drive end **A** and **B** see page 39

* options on request

** both version with key

page intentionally left blank

Compact three-phase motor HB and brake motor HBZ

Section contents

13.1	Compact asynchronous three-phase motor HB	210
13.1.1	General specifications	210
13.2	Technical data of compact asynchronous three-phase motor HB	212
13.3	Compact asynchronous three-phase brake motor HBZ	215
13.3.1	General specifications	215
13.3.2	Brake specifications	217
13.4	Technical data of compact asynchronous three-phase brake motor HBZ	219

13.1

Compact asynchronous three-phase motor HB

13.1.1 General specifications

- **insulation class F**, rise temperature B;
- **mating tolerances under «accuracy» rating**;
- **IP55 protection**;
- **suitable for operation with inverter**;
- asynchronous three-phase **electric motor** with rotor cage, total enclosed, externally ventilated (cooling system IC 411 with cooling fan keyed on motor shaft);
- **single-speed** 2, 4 or 6 poles **motor**;
- particularly strong **construction** (both electrical and mechanical); duly proportioned bearings;
- **«generous» electromagnetic sizing** having margins of safety, good acceleration capacity (high frequency of starting) and uniform starting (slightly «sagged» characteristic curves);
- **metallic terminal box**;
- **designs available** for every application need (independent cooling fan, independent cooling fan and encoder, protections higher than IP 55, etc.)

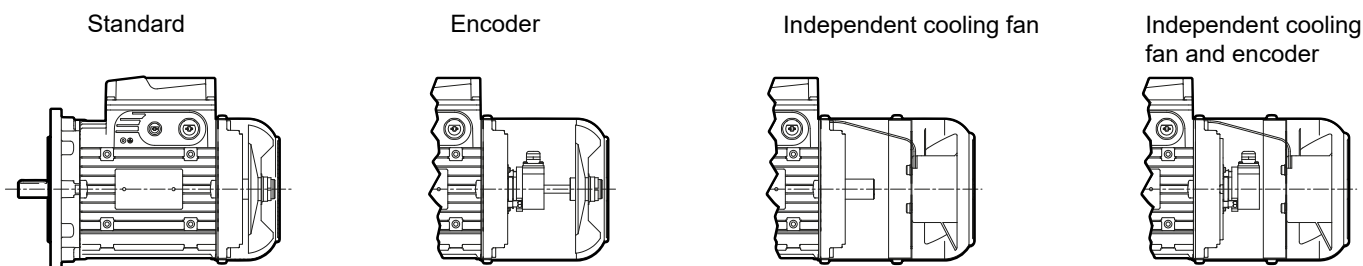

UTC 1374

Rated power delivered on continuous duty (S1) and referred to nominal voltage and frequency, ambient temperature $-15 \div 40$ °C and maximum altitude 1000 m.

Motor housing in pressure diecast light alloy.

Drive end and non-drive end end-shield in cast iron or light alloy.

«Supported» tightening attachments of **endshields and flanges** fitted on housing with «tight» coupling.

Ball bearings lubricated «for life» assuming pollution-free surroundings; preload spring.

Motor shaft axially fastened on drive end.

Rear threaded extraction hole as standard for sizes ≥ 90 ... 132.

Steel fan cover.

Thermoplastic **cooling fan** with radial vanes.

Terminal box made of light alloy (integral with housing with knockout cable openings on both sides, two holes, one for power cable and one for auxiliary equipment).

Left side position non drive end (pos. TB0 see page 40); on request other positions.

Pressure diecast light alloy **terminal box cover.**

Terminal block with 6 terminals (9 terminals for supply voltage YY230 Y460 60 Hz).

Earth terminal located inside terminal box; prearranged for the installation of further two external earth terminals on housing.

Compact three-phase motor HB and brake motor HBZ 13

Rotor: pressure diecast cage rotor in aluminium.

Stator winding with class H copper conductor insulation, insulated with double coat, type of impregnation with resin of class H; other materials are of classes F and H for a class F insulation system.

Materials and type of impregnation allow use in tropical climates without further treatments.

Rotor dynamic balancing: vibration velocity under standard rating A. Motors are balanced with half key inserted into shaft extension.

Painting with bi-component water-based acrylic enamel, color blue RAL 5010 DIN 1843, suitable to resist to normal industrial environments (corrosivity class C3 ISO 12944-2).

For non-standard designs and accessories see page 41.

Compact three-phase motor HB and brake motor HBZ 13

13.2

Technical data of compact asynchronous three-phase motor HB

2 poles - 3000 min⁻¹

IP 55

IC 411

Insulation class F

Temperature rise class B

IE3
400 V - 50Hz
ErP

P_N kW	Motor	n_N min ⁻¹	M_N N m	I_N A 400 V	$\cos \varphi$	η IE3 IEC 60034-2-1			M_s / M_N	M_{max} / M_N	I_s / I_N	J_0 kg m ²	z_0 start/h		
						100%	75%	50%							
1,1	HB3 80 B	2	2875	3,7	2,3	0,84	82,7	83,2	81	3,9	3,9	7,7	0,0013	2500	11,6
1,5	HB3 90 S	2	2890	4,97	2,9	0,88	84,2	84,5	83,3	3,3	3,6	7,9	0,0019	1800	16
2,2	HB3 90 LA	2	2890	7,3	4,4	0,85	85,9	86,2	85,1	3,9	4,4	8,4	0,0023	1600	18
3	HB3 100 LA	2	2930	9,8	6,2	0,80	87,1	87,2	85,2	4,2	5,1	10,1	0,0044	1500	24
4	HB3 112 M	2	2940	13	7,6	0,87	88,1	88,2	86,7	2,8	4,2	9,8	0,0074	1400	33
5,5	HB3 132 S	2	2960	17,8	10,4	0,85	89,2	88,6	85,6	5,2	6,1	12,7	0,0174	710	53
7,5	HB3 132 SB	2	2960	24,3	14	0,85	90,1	89,9	87,3	5,7	6,5	13,6	0,0215	710	61,5

Compact three-phase motor HB and brake motor HBZ 13

4 poles - 1500 min⁻¹

IP 55

IC 411

Insulation class F

Temperature rise class B

IE2
400 V - 50Hz
ErP

P_N	Motor			n_N	M_N	I_N	$\cos \varphi$	η			M_S / M_N	M_{max} / M_N	I_S / I_N	J_0	z_0	
								IEC 60034-2-1								
kW				min ⁻¹	N m	A 400 V		100%	75%	50%				kg m ²	start/h	
0,12	HB2	63 A	4	1370	0,84	0,52	0,61	55	52,2	48,5	2,2	2,5	2,7	0,0002	12500	3,9
0,18	HB2	63 B	4	1360	1,26	0,7	0,63	58,9	56,1	50	2,1	2,3	2,8	0,0003	12500	4,5
0,25	HB2	71 A	4	1400	1,71	0,8	0,68	66,7	66	60,4	2,2	2,5	3,6	0,0007	10000	5,7
0,37	HB2	71 B	4	1400	2,52	1,1	0,68	71,4	70,9	67,8	2,5	2,8	4	0,0009	10000	6,6
0,55	HB2	80 A	4	1405	3,74	1,38	0,78	73,8	74	70,1	2,5	3,58	4,9	0,0019	8000	7,6

4 poles - 1500 min⁻¹

IP 55

IC 411

Insulation class F

Temperature rise class B

IE3
400 V - 50Hz
ErP

P_N	Motor			n_N	M_N	I_N	$\cos \varphi$	η			M_S / M_N	M_{max} / M_N	I_S / I_N	J_0	z_0	
								IEC 60034-2-1								
kW				min ⁻¹	N m	A 400 V		100%	75%	50%				kg m ²	start/h	
0,75	HB3	80 B	4	1410	5,1	2	0,67	82,5	82,2	80,1	3,2	3,3	5,3	0,0018	6800	12
1,1	HB3	90 S	4	1420	7,4	2,4	0,80	84,1	84,8	83,6	3,0	3,5	6,4	0,0041	3150	18,5
1,5	HB3	90 L	4	1430	10,1	3,3	0,78	85,3	86,1	85	3,1	3,7	6,7	0,0043	3000	19
2,2	HB3	100 LA	4	1440	14,6	4,8	0,76	86,7	87,2	85,5	3,5	4,4	7,4	0,0076	3000	26
3	⁽¹⁾ HB3	112 MA	4	1450	19,8	6,1	0,80	88,7	88,6	87,3	3,5	4,4	8,8	0,013	2000	33
4	HB3	112 M	4	1450	26,3	8,5	0,77	88,6	89,2	88	3,7	4,6	9,0	0,014	1800	35
5,5	HB3	132 S	4	1470	35,8	12	0,74	89,6	89,5	87,6	4,5	5,0	9,1	0,0357	900	58
7,5	HB3	132 M	4	1460	49	15,2	0,79	90,4	90,4	89,6	3,9	4,2	8,4	0,0432	900	66
9,2	⁽¹⁾ HB3	132 MB	4	1460	60,2	19,2	0,76	91	90,8	90,1	4,0	4,1	8,5	0,0448	800	68,5

⁽¹⁾ Power not according to standard for the relevant motor size

Compact three-phase motor HB and brake motor HBZ 13

6 poles - 1000 min⁻¹

IP 55

IC 411

Insulation class F

Temperature rise class B

IE2
400 V - 50Hz
ErP

P_N kW	Motor	n_N min ⁻¹	M_N N m	I_N A 400 V	$\cos \varphi$	η IE2 IEC 60034-2-1			M_S / M_N	M_{max} / M_N	I_S / I_N	J_0 kg m ²	z_0 start/h	
						100%	75%	50%						
0,12	HB2 63 B 6	910	1,26	0,57	0,57	53,7	49,5	41,1	2,7	2,8	2,5	0,0005	12500	4,5
0,18	HB2 71 A 6	910	1,89	0,62	0,68	61,6	59,8	51,9	2,4	2,5	3,2	0,0009	12500	6
0,25	HB2 71 B 6	900	2,65	0,85	0,68	62,4	60,7	54	2,5	2,6	3,2	0,0012	11200	6,8
0,37	HB2 80 A 6	930	3,8	1,2	0,67	66,8	65,4	58,4	2,5	2,6	3,6	0,0019	9500	8
0,55	HB2 80 B 6	920	5,7	1,68	0,68	69,8	69,7	64,9	2,5	2,6	3,7	0,0025	9000	9,6

6 poles - 1000 min⁻¹

IP 55

IC 411

Insulation class F

Temperature rise class B

IE3
400 V - 50Hz
ErP

P_N kW	Motor	n_N min ⁻¹	M_N N m	I_N A 400 V	$\cos \varphi$	η IE3 IEC 60034-2-1			M_S / M_N	M_{max} / M_N	I_S / I_N	J_0 kg m ²	z_0 start/h	
						100%	75%	50%						
0,75	HB3 90 S 6	930	7,7	2	0,72	78,9	76	73	2,1	2,9	4,9	0,0056	6000	15,5
1,1	HB3 90 L 6	930	11,3	2,8	0,72	81	79	77	2,6	3	5,1	0,0071	5600	19,5
1,5	HB3 100 LA 6	950	15,1	3,5	0,75	82,5	82,4	80,4	2,5	3,4	6,5	0,013	3000	26
2,2	HB3 112 M 6	960	21,9	5,1	0,73	84,3	85	83,2	2,3	3,5	6,9	0,0202	2800	33
3	HB3 132 S 6	970	29,5	6,9	0,72	85,6	88	86,3	2,4	3,8	7,6	0,0435	1400	54

Compact asynchronous three-phase brake motor HBZ

13.3.1 General specifications

- **Insulation class F**, rise temperature B;
- **mating tolerances under «accuracy» rating**;
- **IP55 protection**;
- **suitable for operation with inverter**;
- **electric asynchronous three-phase brake motor with d.c. brake** (braking in case of supply failure) with **double braking surface with braking torque proportioned to motor torque** (usually $M_f \approx 2 M_N$);
- **single-speed 2, 4 or 6, poles motor**;
- **particularly strong construction** (both electrical and mechanical) to withstand alternating torsional and thermic stresses of starting and braking; duly proportioned bearings;
- **electromagnetic sizing especially studied** to allow high acceleration capacity (high frequency of starting) and uniform starting;
- **large metal terminal box**, multivoltage rectifier, one brake coil, for **voltage always coordinated** with the motor one (both Δ and Y);
- **maximum reduced noise level and operation progressivity** (both at starting and braking) thanks to a lower rapidity (typical of d.c. brake) of the anchor (which is lighter and less quick in the impact): motor starts slightly braked i.e. with greater progressivity; good release and braking rapidity; possibility to increase rapidity in braking, with supply opening on d.c. side;
- **high braking capacity**;
- **designs available** for every application need (independent cooling fan, independent cooling fan and encoder, protections higher than IP 55, etc.);
- **particularly suitable** for applications requiring **regular and low-noise starting and braking** and, at the same time, braking with good rapidity and precision and high number of starts.

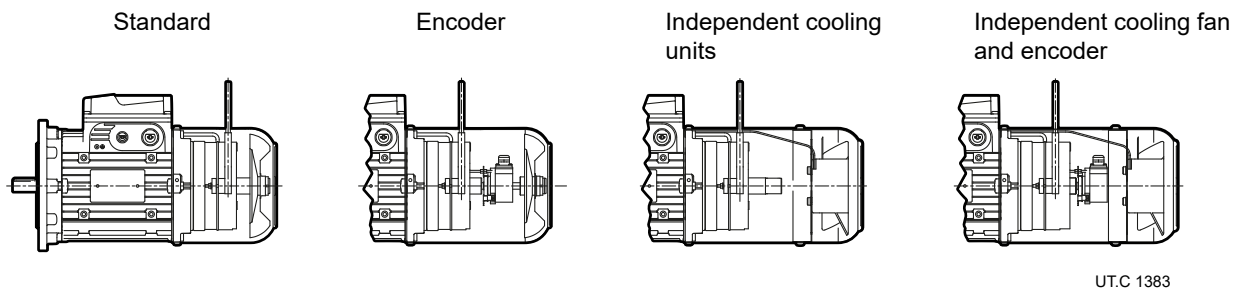

«Torque-speed» **characteristic curves** duly optimized for handling (horizontal and vertical traverse movements, rotation), slightly «sagged», without peaks in the hypersynchronous area and with carefully proportioned mean value.

Rated power delivered on continuous duty (S1) and referred to nominal voltage and frequency, ambient temperature $-15 \div +40$ °C and maximum altitude 1 000 m.

Housing in pressure diecast light alloy.

Drive end flange and non-drive end endshield in cast iron or light alloy.

«Supported» tightening attachments of **endshields and flanges** fitted on housing with «tight» coupling.

Ball bearings lubricated «for life» assuming pollution-free surroundings; preload spring.

Motor shaft in steel axially fastened on drive end endshield.

Rear threaded extraction hole.

Steel **fan cover**.

Thermoplastic **cooling fan** with radial vanes.

Terminal box made of light alloy (integral with housing with knockout cable openings on both sides, two holes, one for power cable and one for auxiliary equipment). Left side position non drive end (pos. TB0 see page 40); on request other positions. Pressure diecast light alloy **terminal box cover**.

Terminal block with 6 terminals (9 terminals for supply voltage YY230 Y460 60 Hz).

Earth terminal located inside terminal box; prearranged for the installation of further two external earth terminals on housing.

Brake supply: with rectifier laying in terminal box having 2 terminals for cable connection for rectifier supply, 2 for rapid braking external contact; possible brake supply **directly from motor terminal block** or **separately** (to use for: motors supplied by inverter, separate drive needs of motor and brake, etc.). Brake can be supplied, also at motor standstill, with no time limitations.

Rotor: pressure diecast cage rotor in aluminium.

Stator winding with class H copper conductor insulation, insulated with double coat, type of impregnation with resin of class H; other materials are of classes F and H for a class F insulation system.

Rotor **dynamic balancing:** vibration velocity under standard rating A. Motors are balanced with half key inserted into shaft extension.

Painting with two-component water based acrylic enamel, color blue RAL 5010 DIN 1843, suitable for normal industrial environments (corrosivity class C3 ISO 12944-2)

For **non-standard designs** and accessories see page 41.

13.3.2 Brake specifications

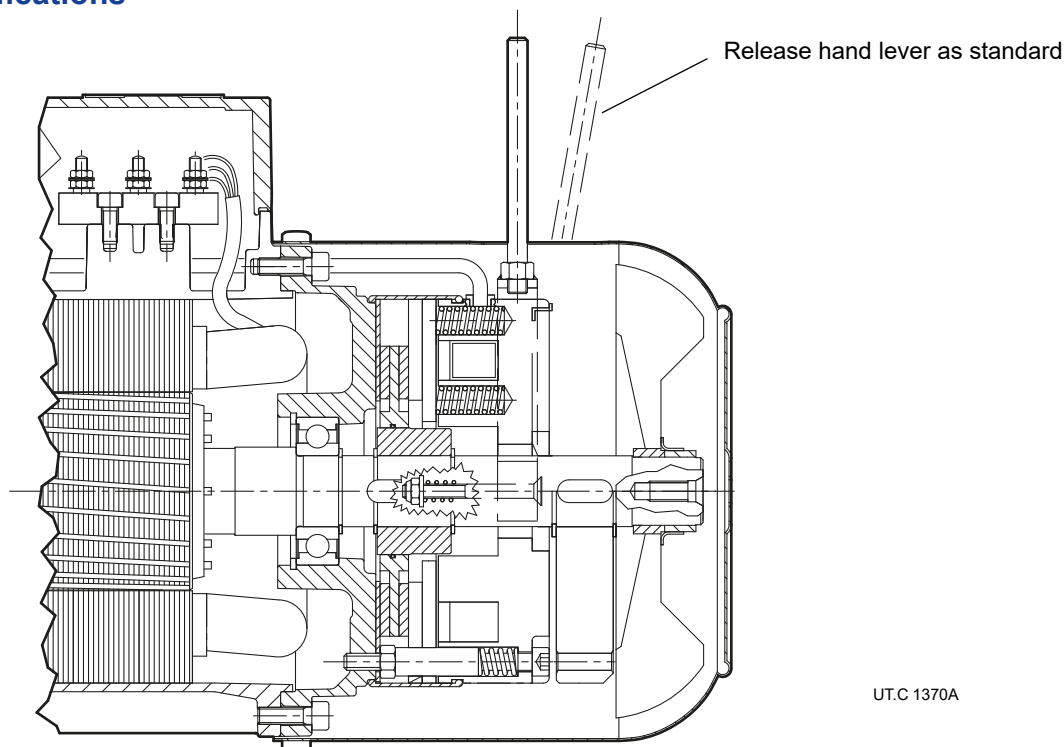

Electromagnetic spring loaded brake (braking occurs automatically when it is not supplied), with **d.c.** toroidal coil and double braking surface, braking torque proportioned to motor torque (usually $M_f \approx 2 M_N$).

Maximum reduced noise level and operation progressivity (both at starting and braking thanks to a lower rapidity, typical of d.c. brake, of the anchor, which is lighter and less quick in the impact: motor starts slightly braked i.e. with greater progressivity); **good release and braking rapidity**; possibility to increase rapidity, both in releasing (with rapid rectifier) and braking, with supply opening on d.c. side; high braking capacity.

Designs available for every application (encoder, independent cooling fan, independent cooling fan and encoder, second shaft end, etc.).

Particularly suitable for applications requiring regular and low-noise starting and braking and, at the same time, braking with good rapidity and precision and high number of starts.

When electromagnet is not supplied, the brake anchor pushed by springs, presses the brake disk on rear end-shield generating the braking torque on the same brake disk and consequently on motor shaft it is keyed onto; by supplying the brake the electromagnet draws the brake anchor and releases brake disk and driving shaft.

Key features:

- **multivoltage rectifier** (as standard), specifically designed for the management of a **brake coil only** with supply voltage always coordinated with standard voltage of HBZ motor ($\Delta 230 Y400 V \pm 5\% 50 Hz$ and accordingly also $\Delta 277 Y480 V \pm 5\% 60 Hz$); **other voltages** on request;
- **rectifier supply directly from motor terminal block** or indifferently from a separate line;
- **braking torque** adjustable by changing number of springs;
- **insulation class F**, temperature rise class B;
- **brake disk**, sliding on moving hub: with single steel coat and double friction surface with average friction coefficient for low wear;
- **brake anchor in two pieces** for greater rapidity of starting and reduced noise;
- **water-proof and dust-proof gaiter and V-ring** both to prevent polluting infiltrations from surroundings towards brake, and to avoid that wear dust of friction surface will be dispersed in the surroundings;
- **lever for manual release with automatic return (as standard)** and removable level rod; position of release lever corresponding to terminal box; on request, other possible positions. Contact Rossi S.p.A.;
- **for other running specifications** see following table.

For **non-standard designs** and accessories see page 41.

Motor is always **equipped with a high reliable rectifier** fixed on terminal box providing adequate connecting terminal (2 for rectifier supply directly from motor terminal block or separate; 2 for external contact of rapid braking).

Multivoltage rectifiers **RM1**⁽¹⁾ (supplied as standard for brakes 12 ... 14) and **RM2**⁽¹⁾ (supplied as standard for brakes 05 ... 07) are a.c./d.c. supply voltage devices with full-wave controlled bridge able to **supply output voltage value independently from input voltage**.

The DC brake is suitable for power supply

range 110 ÷ 440 V a.c. (for brake sizes 12 ÷ 15)
range 200 ÷ 440 V a.c. (for brake sizes 06S ... 07)

without having to change the coil and therefore is also always coordinated with both motor voltages.

In the supply range 200 ÷ 440 V a.c., the rectifier also has an integrated speed-up function (a higher voltage than the nominal voltage is supplied to the brake coil for approx. 400 ms at the start, allowing the brake to be released more quickly).

In addition, compared to a conventional rectifier, multi-voltage also offers the following advantages:

- greater constancy of the brake performance (the output voltage being at a constant predefined value independent of fluctuations in the supply voltage);
- lower brake holding voltage (75 V d.c.) in the released state (lower power consumption, less coil heating and shorter braking delay).

Both models of rectifiers (RM1, RM2) can be switched on and off either on the a.c. side (for maximum quiet operation), or on the a.c. and d.c. sides. (for faster braking), as they are equipped with varistors to protect the diodes, the electromagnet and the d.c. side opening contact.

Main functional brake specifications

Actual values may deviate slightly depending on the ambient temperature and humidity, the brake temperature and the wear condition of the friction linings.

Brake size	Motor size	M_f			Absorption			Delay of			Air-gap		W_1 ⁽⁶⁾	C_{max} ⁽⁷⁾	W_{max} ⁽⁸⁾			
		2 springs N m	4 springs N m	6 springs N m	V a.c.	A a.c. max	W	release t_1 ⁽⁴⁾ ms	braking t_2 ms	t_2 ⁽⁵⁾ (d.c.) ms	mm min	mm max			brakings/h			
(2)															10	100	1000	
BZ 12	RM1	63 71	1,75	3,5	-	110 ÷ 440	0,09	9	20	100	10	0,25	0,40	70	5	4500	1120	160
BZ 53,13	RM1	71 80	2,5	5	7,5	110 ÷ 440	0,14	12	32	120	10	0,25	0,40	90	5	5600	1400	200
BZ 04, 14	RM1	80 90	5	11	16	110 ÷ 440	0,20	16	45	150	10	0,30	0,45	125	5	7500	1900	265
BZ 05, 15	RM2	90 100 112	13	27	40	110 ÷ 440	0,26	24	63	220	15	0,30	0,45	160	5	10000	2500	355
BZ 06 S	RM2	112	25	50	75	200 ÷ 440	0,28	30	90	300	30	0,35	0,55	220	5	14000	3550	500
BZ 56	RM2	132 S	37	75	-	200 ÷ 440	0,28	50	90	224	20	0,35	0,55	224	4,5	14000	3550	500
BZ 06	RM2	132 S, M	50	100	-	200 ÷ 440	0,28	50	90	224	20	0,35	0,55	224	4,5	14000	3550	500
BZ 07	RM2	132 MB	50	100	150	200 ÷ 440	0,34	65	125	280	25	0,40	0,60	315	4,5	20000	5000	710

⁽¹⁾ The multivoltage rectifiers RM1 and RM2 are patented devices.

⁽²⁾ Standard rectifier, supplied as standard; the rest time must be between 2.5 s ÷ 3.5 s. If necessary, please contact Rossi S.p.A.

⁽³⁾ Values valid with M_{fmax} , mean air-gap, nominal value of supply voltage.

⁽⁴⁾ Brake release time obtained with standard rectifier and, for RM1, with supply voltage 200 V c.a.

⁽⁵⁾ Braking delay obtained with separate brake supply and disconnection on a.c. side of rectifier (t_2) or on a.c. and d.c. side. (t_2 d.c.)

With direct supply from motor terminal block, the values of t_2 increase by approx. 2,5 times the ones stated in the table.

⁽⁶⁾ Work of friction generating a brake disk wear of 1 mm. (minimum value for heavy application, real value is usually greater).

⁽⁷⁾ Maximum brake disk wear.

⁽⁸⁾ Maximum friction work for each braking.

Technical data of compact asynchronous three-phase brake motor HBZ

2 poles - 3000 min⁻¹

IP55

IC411

Insulation class F

Temperature rise class B

IE3
400 V - 50Hz
ErP

P_N kW	Motor	n_N min ⁻¹	M_N N m	I_N A 400V	$\cos \varphi$	η IE3 IEC 60034-2-1			M_S / M_N	M_{max} / M_N	I_S / I_N	J_0 kg m ²	Brake	M_f N m	z_0 start/h		
						100%	75%	50%									
1,1	HB3Z 80 B	2	2875	3,7	2,3	0,84	82,7	83,2	81	3,9	3,9	7,7	0,0015	BZ04	11	2500	15,5
1,5	HB3Z 90 S	2	2890	4,97	2,9	0,88	84,2	84,5	83,3	3,3	3,6	7,9	0,0021	BZ14	11	1800	20
2,2	HB3Z 90 LA	2	2890	7,3	4,4	0,85	85,9	86,2	85,1	3,9	4,4	8,4	0,0027	BZ05	27	1600	24
3	HB3Z 100 LA	2	2930	9,8	6,2	0,80	87,1	87,2	85,2	4,2	5,1	10,1	0,0048	BZ15	27	1500	30
4	HB3Z 112 M	2	2940	13	7,6	0,87	88,1	88,2	86,7	2,8	4,2	9,8	0,0078	BZ15	27	1400	39
5,5	HB3Z 132 S	2	2960	17,8	10,4	0,85	89,2	88,6	85,6	5,2	6,1	12,7	0,0184	BZ06	50	710	64
7,5	HB3Z 132 SB	2	2960	24,3	14	0,85	90,1	89,9	87,3	5,7	6,5	13,6	0,0225	BZ06	50	710	72,5

4 poles - 1500 min⁻¹

IP55

IC411

Insulation class F

Temperature rise class B

IE2
400 V - 50Hz
ErP

P_N kW	Motor	n_N min ⁻¹	M_N N m	I_N A 400V	$\cos \varphi$	η IE2 IEC 60034-2-1			M_S / M_N	M_{max} / M_N	I_S / I_N	J_0 kg m ²	Brake	M_f N m	z_0 start/h	
						100%	75%	50%								
0,12	HB2Z 63 A 4	1370	0,84	0,52	0,61	55	52,2	48,5	2,2	2,5	2,7	0,0003	BZ12	1,75	12500	5,7
0,18	HB2Z 63 B 4	1360	1,26	0,7	0,63	58,9	56,1	50	2,1	2,3	2,8	0,0004	BZ12	3,5	12500	6,3
0,25	HB2Z 71 A 4	1400	1,71	0,8	0,68	66,7	66	60,4	2,2	2,5	3,6	0,0008	BZ53	5	10000	8,4
0,37	HB2Z 71 B 4	1400	2,52	1,1	0,68	71,4	70,9	67,8	2,5	2,8	4	0,0010	BZ53	5	10000	9,3
0,55	HB2Z 80 A 4	1405	3,74	1,38	0,78	73,8	74	70,1	2,5	3,58	4,9	0,0019	BZ04	11	8000	11,5

4 poles - 1500 min⁻¹

IP55

IC411

Insulation class F

Temperature rise class B

IE3
400 V - 50Hz
ErP

P_N kW	Motor	n_N min ⁻¹	M_N N m	I_N A 400V	$\cos \varphi$	η IE3 IEC 60034-2-1			M_S / M_N	M_{max} / M_N	I_S / I_N	J_0 kg m ²	Brake	M_f N m	z_0 start/h	
						100%	75%	50%								
0,75	HB3Z 80 B 4	1410	5,1	2	0,67	82,5	82,2	80,1	3,2	3,3	5,3	0,0020	BZ04	11	6800	16
1,1 ⁽¹⁾	HB3Z 90 S 4	1420	7,4	2,4	0,80	84,1	84,8	83,6	3,0	3,5	6,4	0,0043	BZ14	16	3150	22,5
1,5 ⁽¹⁾	HB3Z 90 L 4	1430	10,1	3,3	0,78	85,3	86,1	85	3,1	3,7	6,7	0,0047	BZ05	27	3000	25
2,2 ⁽¹⁾	HB3Z 100 LA 4	1440	14,6	4,8	0,76	86,7	87,2	85,5	3,5	4,4	7,4	0,0080	BZ15	40	3000	32
3 ⁽¹⁾	HB3Z 112 MA 4	1450	19,8	6,1	0,80	88,7	88,6	87,3	3,5	4,4	8,8	0,0130	BZ15	40	2000	39
4	HB3Z 112 M 4	1450	26,3	8,5	0,77	88,6	89,2	88	3,7	4,6	9,0	0,0150	BZ06 S	75	1800	44
5,5	HB3Z 132 S 4	1470	35,8	12	0,74	89,6	89,5	87,6	4,5	5,0	9,1	0,0367	BZ56	75	900	69
7,5	HB3Z 132 M 4	1460	49	15,2	0,79	90,4	90,4	89,6	3,9	4,2	8,4	0,0442	BZ06	100	900	77
9,2 ⁽¹⁾	HB3Z 132 MB 4	1460	60,2	19,2	0,76	91	90,8	90,1	4,0	4,1	8,5	0,0470	BZ07	150	800	80,5

⁽¹⁾ Power not according to standard for the relevant motor size

Compact three-phase motor HB and brake motor HBZ 13

6 poles - 1000 min⁻¹

IP55

IC411

Insulation class F

Temperature rise class B

IE2
400 V - 50Hz
ErP

P_N kW	Motor	n_N min ⁻¹	M_N N m	I_N A 400V	$\cos \varphi$	η IE2 IEC 60034-2-1			M_S / M_N	M_{max} / M_N	I_S / I_N	J_0 kg m ²	Brake	M_f N m	z_0 start/h	
						100%	75%	50%								
0,12	HB2Z 63 B 6	910	1,26	0,57	0,57	53,7	49,5	41,1	2,7	2,8	2,5	0,0005	BZ12	3,5	12500	6,3
0,18	HB2Z 71 A 6	910	1,89	0,62	0,68	61,6	59,8	51,9	2,4	2,5	3,2	0,0010	BZ53	5	11200	8,7
0,25	HB2Z 71 B 6	900	2,65	0,85	0,68	62,4	60,7	54	2,5	2,6	3,2	0,0013	BZ53	5	11200	9,5
0,37	HB2Z 80 A 6	930	3,8	1,2	0,67	66,8	65,4	58,4	2,5	2,6	3,6	0,0021	BZ04	11	9500	12
0,55	HB2Z 80 B 6	920	5,7	1,68	0,68	69,8	69,7	64,9	2,5	2,6	3,7	0,0027	BZ04	16	9000	13,5

6 poles - 1000 min⁻¹

IP55

IC411

Insulation class F

Temperature rise class B

IE3
400 V - 50Hz
ErP

P_N kW	Motor	n_N min ⁻¹	M_N N m	I_N A 400V	$\cos \varphi$	η IE3 IEC 60034-2-1			M_S / M_N	M_{max} / M_N	I_S / I_N	J_0 kg m ²	Brake	M_f N m	z_0 start/h	
						100%	75%	50%								
0,75	HB3Z 90 S 6	930	7,7	2	0,72	78,9	76	73	2,1	2,9	4,9	0,0057	BZ14	16	7100	19,5
1,1	HB3Z 90 L 6	930	11,3	2,8	0,72	81	79	77	2,6	3	5,1	0,0071	BZ05	27	5300	26
1,5	HB3Z 100 LA 6	950	15,1	3,5	0,75	82,5	82,4	80,4	2,5	3,4	6,5	0,0133	BZ15	40	3000	32
2,2	HB3Z 112 M 6	960	21,9	5,1	0,73	84,3	85	83,2	2,3	3,5	6,9	0,0211	BZ06S	50	2800	42
3	HB3Z 132 S 6	970	29,5	6,9	0,72	85,6	88	86,3	2,4	3,8	7,6	0,0445	BZ56	75	1400	65

Installation and maintenance

Section contents

14.1	Safety	224
14.2	Installation and maintenance	225

14.1

Safety

Important:

The gearmotors supplied by Rossi S.p.A. must be incorporated into machinery and **should not be commissioned before the machinery or system in which the components have been incorporated conforms to:**

- **Machinery directive 2006/42/EC and subsequent updatings; in particular, possible safety guards for shaft ends not being used and for eventually accessible fan cover passages (or other) are the Buyer's responsibility;**
- **«Electromagnetic compatibility (EMC)» 2004/108/EC and subsequent updatings.**



Attention!

It is recommended to pay attention to all instructions of present handbook, all existing safety laws and standards concerning correct installation. Whenever personal injury or property damage may occur, due to falling or projecting parts of gear reducer or of its parts, foresee adequate supplementary protection devices against loosening or breaking of the fastening screws.

If deviations from normal operation occur (temperature increase, vibrations, unusual noise, etc.) immediately switch off the machine.

Safety during installation

An incorrect installation, an improper use, the removing or disconnection of protection devices, the lack of inspections and maintenance, improper connections may cause severe personal injury or property damage.

Therefore the component must be moved, installed, commissioned, handled, controlled, serviced and re-paired **exclusively by responsible qualified personnel specifically instructed** and have the necessary experience to recognize any risks connected with present products avoiding any possible emergencies.

Gear reducers and gearmotors of present catalog are normally suitable for installations in industrial areas: additional protection measures, if necessary, must be adopted and assured by the personnel responsible for the installation.



Attention!

Motors in non-standard design or with constructive **variations** may differ in the details from the ones described here following and may require additional information.



Attention!

For the installation, use and maintenance of the electric motor of the possible motor-variator and/or the electric supply device (frequency converter, soft-start, etc.), and/or any optional electric devices (e.g.: independent cooling fan, etc.), consult the specific attached documentation. If necessary, require it.

Safety during maintenance

When operating on gear reducer or on components connected to it, the **machine must be at rest, disconnected from power supply and cold**: disconnect motor (including auxiliary equipments) from power supply, gear reducer from load, be sure that safety systems are on against any accidental starting and, if necessary, pre-arrange mechanical locking devices (to be removed before commissioning).



Attention!

During the running the gear reducers could have **hot surfaces**; Always wait that the gear reducer or the gearmotor to cool before carrying out any operations. Further technical documentation (e.g. catalogs) can be downloaded from our website **www.rossi.com**.

Be sure that the structure on which gearmotor is fitted is plane, levelled and sufficiently dimensioned in order to assure fitting stability and vibration absence, keeping in mind all transmitted forces due to the masses, to the torque, to the radial and axial loads.

Position the gearmotor so as to allow a free passage of air for cooling both gear reducer and motor (especially at motor fan side).

Avoid: any obstruction to the air-flow; heat sources near the gearmotor that might affect the temperature of cooling-air and of gearmotor for radiation; insufficient air recycle or any other factor hindering the steady dissipation of heat. Mount the gearmotor so as not to receive vibrations.

When external loads are present use pins or locking blocks, if necessary.

When fitting gear reducer and machine and/or gear reducer and eventual flange B5 it is recommended to use **locking adhesives** such as LOCTITE on the fastening screws (also on flange mating surfaces).

For outdoor installation or in a hostile environment protect the gearmotor with anticorrosion paint. Added protection may be afforded by water-repellent grease (especially around the rotary seating of seal rings and the accessible zones of shaft end).

Gearmotors should be protected wherever possible, and by whatever appropriate means, from solar radiation and extremes of weather; weather protection **becomes essential** when the low or high speed shafts or when motor is vertical with fan on the top.

For ambient temperatures higher than 40 °C or lower than 0 °C, contact Rossi S.p.A.

Before wiring-up the gearmotor, make sure that motor voltage corresponds to input voltage. If direction of rotation is not as desired, invert two phases at the terminals.

If overloads are imposed for long periods or if shocks or danger of jamming are envisaged, then motor-protection, electronic torque limiters, fluid couplings, safety couplings, control units or other similar devices should be fitted.

Where duty cycles involve a high number of starts on-load, it is advisable to utilize **thermal probes** (fitted on the wiring) for motor protection; a thermal overload relay is unsuitable since its threshold must be set higher than the motor's nominal current rating.

Use varistors to limit voltage peaks due to contactors.



Attention!

Bearing life and good shaft and coupling running depend on alignment precision between the shafts.

Carefully align the gearmotor with the driven machine (with the aid of shims if need be), interposing flexible couplings whenever possible.

Whenever a leakage of lubricant could cause heavy damages, increase the frequency of inspections and/or envisage appropriate control devices (e.g.: remote oil level gauge, lubricant for food industry, etc.).

In polluting surroundings, take suitable precautions against lubricant contamination through seal rings or other.

For brake or non-standard motors, consult us for specific information.

Fitting of components to low speed shaft ends

It is recommended that the bore of parts keyed to low speed shaft ends is machined to K7 tolerance (H7 when load is uniform and light).

Before mounting, thoroughly clean mating surfaces and lubricate against seizure and fretting corrosion. Installing and removal operations should be carried out with pullers and jacking screws using the tapped hole at the shaft butt-end.

Machine pivot

For the machine pivot the gear reducer hollow shaft is to be keyed onto we recommend the dimensions stated on page 12.

1 Application conditions

Application / Industry sector

Type of machine to be driven

- new machine
- existing machine, running gear reducer currently applied

Ambient temperature [°C]

min standard max

Altitude [m above sea level]

Environment:

- normal (industrial) indoor
- normal (industrial) outdoor
- dusty
- corrosive / humid

Gear reducer position:

- small environment with limited air movement ($v_{air} < 0,63$ m/s)
- wide environment with free air movement ($v_{air} > 1,25$ m/s)
- open space, protected against extremes of weather and solar radiance

2 Load data

Required output speed [min⁻¹]

min nominal max

Torque required at low speed shaft [N m]

min nominal max

Required output power [kW]

min nominal max

Input speed (gear reducers) [min⁻¹]

min nominal max

Nature of load:

- uniform
- moderate overloads
- heavy overloads

Frequency of starting [starts/h]

Machine moment of inertia [kg m²]

min standard max

Running time [h/d]

Total duration [h]

Duty cycle (S1 ... S10)

Load cycle attached

- yes
- no

3 Motor

Motor type:

- asynchronous three-phase (a.c.)
- asynchronous three-phase with inverter
- d.c. motor with relevant converter
- internal combustion motor (single-cylinder)
- internal combustion motor (multi-cylinder)

Power P_1 [kW]

min nominal max

Nominal speed n_1 [min⁻¹]

min nominal max

a.c. motor supply:

voltage [V] frequency [Hz]

IEC motor size (a.c. motor)

Type of a.c. motor starting:

- direct
- Y / Δ
- soft starter / inverter

Electromagnetic motor

- parking brake
- work
- safety

Braking torque [N m]

Starting torque [N m]

Moment of inertia [kg m²]

Electric motor design (a.c. and d.c.):

- with independent cooling fan
- with encoder:
- with tachogenerator

System of motor-gear reducer mounting:

- with coupling
- with trapezoidal belts

section	No.	d_m [mm]	d_f [mm]
<input type="text"/>	<input type="text"/>	<input type="text"/>	<input type="text"/>
- with toothed belt drive

section	No.	d_m [mm]
<input type="text"/>	<input type="text"/>	<input type="text"/>

Eventual limit to drive dimensions

4 Gear reducer

Mounting position

Direction of rotation of output shaft

- white arrow
- black arrow
- white and black arrow

Backstop device (if present)

- free rotation, white arrow
- free rotation, black arrow

Type of admitted cooling

- with fan
- with coil
- with internal exchanger
- with UR O/A unit
- with UR O/W unit

Type of machine coupling

- shaft mounting
- with fluid / flexible coupling
- with cardan joint
- with toothed belt drive

pitch d_m d_f ϕ

- with chain

pitch No. z_2 z_3 overhang [mm] ϕ

- straight tooth cylindrical gear

pitch No. z_2 z_3 overhang [mm] ϕ

Eventual axial load F_a [N]

Eventual limit to drive dimensions

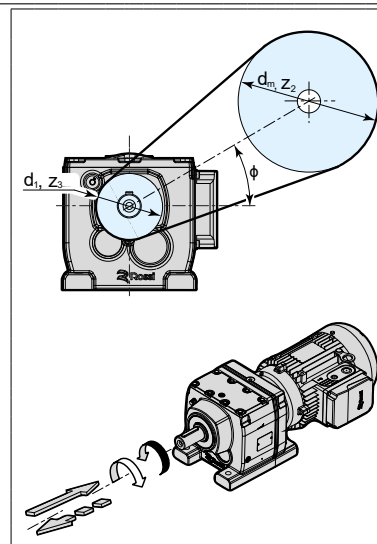

Frame size	With Technical System units	With SI units
starting or stopping time as a function of an acceleration or deceleration, of a starting or braking torque	$t = \frac{v}{a} \text{ [s]}$ $t = \frac{Gd^2 \cdot n}{375 \cdot M} \text{ [s]}$	$t = \frac{J \cdot \omega}{M} \text{ [s]}$
velocity in rotary motion	$v = \frac{\pi \cdot d \cdot n}{60} = \frac{d \cdot n}{19,1} \text{ [m/s]}$	$v = \omega \cdot r \text{ [m/s]}$
angular velocity	$n = \frac{60 \cdot v}{\pi \cdot d} = \frac{19,1 \cdot v}{d} \text{ [min}^{-1}\text{]}$	$\omega = \frac{v}{r} \text{ [rad/s]}$
acceleration or deceleration as a function of starting or stopping time		$a = \frac{v}{t} \text{ [m/s}^2\text{]}$
angular acceleration or deceleration as a function of a starting or stopping time, of a starting or braking torque	$\alpha = \frac{n}{9,55 \cdot t} \text{ [rad/s}^2\text{]}$ $\alpha = \frac{39,2 \cdot M}{Gd^2} \text{ [rad/s}^2\text{]}$	$\alpha = \frac{\omega}{t} \text{ [rad/s}^2\text{]}$ $\alpha = \frac{M}{J} \text{ [rad/s}^2\text{]}$
starting or stopping distance as a function of an acceleration or deceleration, of a final or initial velocity		$s = \frac{a \cdot t^2}{2} \text{ [m]}$ $s = \frac{v \cdot t}{2} \text{ [m]}$ $w = \frac{\alpha \cdot t^2}{2} \text{ [rad]}$
starting or stopping angle as a function of an angular acceleration or deceleration, of a final or initial angular velocity	$\varphi = \frac{n \cdot t}{19,1} \text{ [rad]}$	$\varphi = \frac{\omega \cdot t}{2} \text{ [rad]}$
mass	$m = \frac{G}{g} \left[\frac{\text{kgf s}^2}{\text{m}} \right]$	m è l'unità di massa [kg]
weight (weight force)	G è l'unità di peso (forza peso) [kgf]	$G = m \cdot g \text{ [N]}$
force in vertical (lifting), horizontal, inclined motion of translation (μ = coefficient of friction; φ = angle of inclination)	$F = G \text{ [kgf]}$ $F = \mu \cdot G \text{ [kgf]}$ $F = G (\mu \cdot \cos \varphi + \sin \varphi) \text{ [kgf]}$	$F = m \cdot g \text{ [N]}$ $F = \mu \cdot m \cdot g \text{ [N]}$ $F = m \cdot g (\mu \cdot \cos \varphi + \sin \varphi) \text{ [N]}$
dynamic moment Gd^2 , moment of inertia J due to a motion of translation (numerically $J = \frac{Gd^2}{4}$)	$Gd^2 = \frac{365 \cdot G \cdot v^2}{n^2} \text{ [kgf m}^2\text{]}$	$J = \frac{m \cdot v^2}{\omega^2} \text{ [kg m}^2\text{]}$
torque as a function of a force, of a dynamic moment or of a moment of inertia, of a power	$M = \frac{F \cdot d}{2} \text{ [kgf m]}$ $M = \frac{Gd^2 \cdot n}{375 \cdot t} \text{ [kgf m]}$ $M = \frac{716 \cdot P}{n} \text{ [kgf m]}$	$M = F \cdot r \text{ [N m]}$ $M = \frac{J \cdot \omega}{t} \text{ [N m]}$ $M = \frac{P}{\omega} \text{ [N m]}$
work, energy in motion of translation, in rotary motion	$W = \frac{G \cdot v^2}{19,6} \text{ [kgf m]}$ $W = \frac{Gd^2 \cdot n^2}{7160} \text{ [kgf m]}$	$W = \frac{m \cdot v^2}{2} \text{ [J]}$ $W = \frac{J \cdot \omega^2}{2} \text{ [J]}$
power in motion of translation, in rotary motion	$P = \frac{F \cdot v}{75} \text{ [CV]}$ $P = \frac{M \cdot n}{716} \text{ [CV]}$	$P = F \cdot v \text{ [W]}$ $P = M \cdot \omega \text{ [W]}$
power available at the shaft of a single-phase motor ($\cos \varphi$ = power factor)	$P = \frac{U \cdot I \cdot \eta \cdot \cos \varphi}{736} \text{ [CV]}$	$P = U \cdot I \cdot \eta \cdot \cos \varphi \text{ [W]}$
power available at the shaft of a three-phase motor	$P = \frac{U \cdot I \cdot \eta \cdot \cos \varphi}{425} \text{ [CV]}$	$P = 1,73 \cdot U \cdot I \cdot \eta \cdot \cos \varphi \text{ [W]}$

Note. Acceleration or deceleration are understood constant; motion of translation and rotary motion are understood rectilinear and circular respectively.

Notes

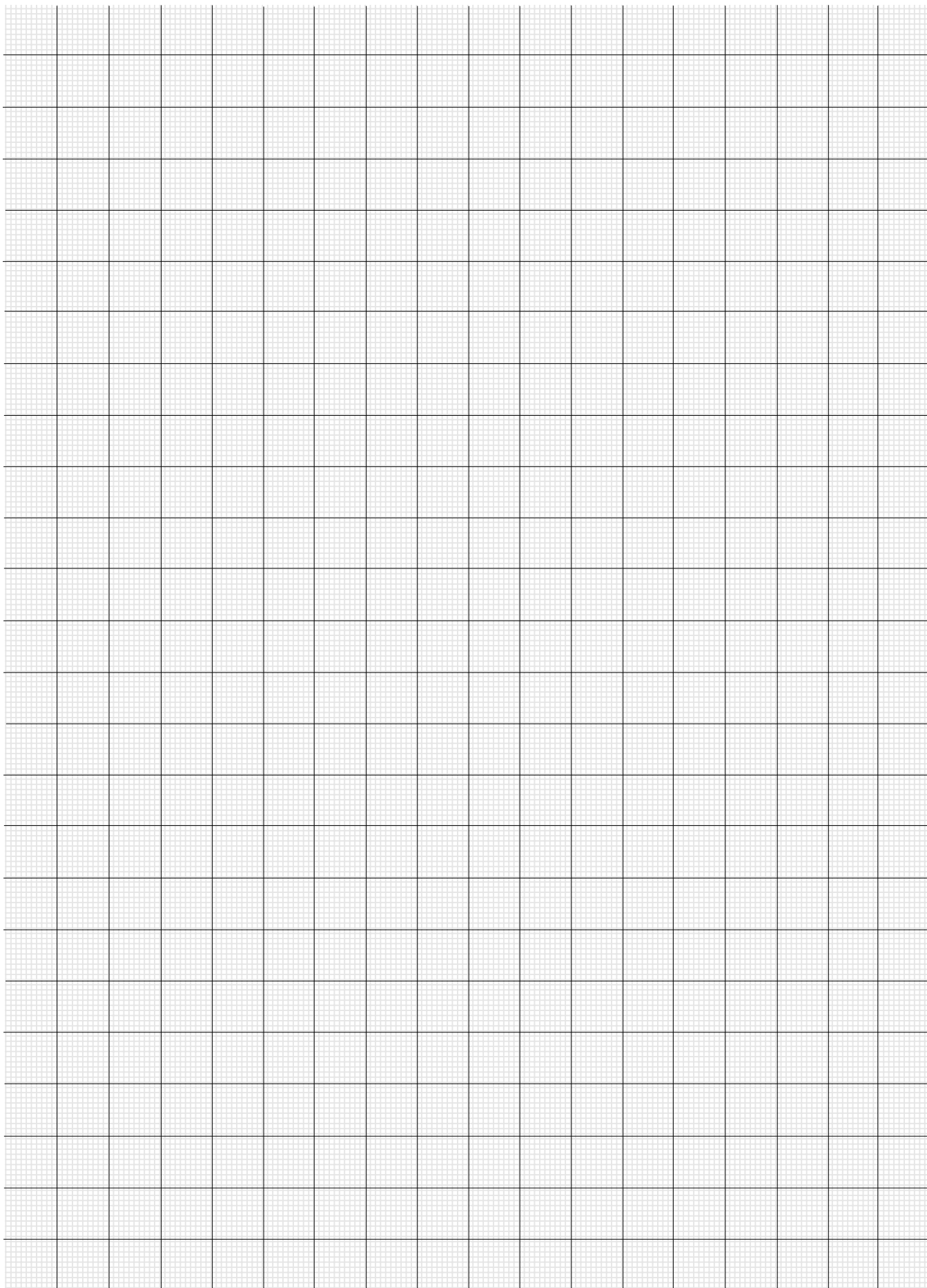

Rossi S.p.A.
Via Emilia Ovest 915/A
41123 Modena - Italy

info@rossi.com
www.rossi.com

2635.CAT.iFIT-iC-iO-23.03-1-EN

© Rossi S.p.A. Rossi reserves the right to make any modification whenever to this publication contents. The information given in this document only contains general descriptions and/or performance features which may not always specifically reflect those described.

The Customer is responsible for the correct selection and application of product in view of its industrial and/or commercial needs, unless the use has been recommended by technical qualified personnel of Rossi, who were duly informed about Customer's application purposes. In this case all the necessary data required for the selection shall be communicated exactly and in writing by the Customer, stated in the order and confirmed by Rossi. The Customer is always responsible for the safety of product applications. Every care has been taken in the drawing up of the catalog to ensure the accuracy of the information contained in this publication, however Rossi can accept no responsibility for any errors, omissions or outdated data. Due to the constant evolution of the state of the art, Rossi reserves the right to make any modification whenever to this publication contents. The responsibility for the product selection is of the Customer, excluding different agreements duly legalized in writing and undersigned by the Parties.